

MEMORANDUM

To: Delfa Genova, P.E.

From: Matthew Martinez, S.E. *M.M.* Valentina Vasquez Rossier, P.E. *V.V.R.*

Date: August 22, 2024

Subject: H2225961 Ocean Beach Pier 2024 Assessment – Stabilization Concepts (Memo No. 3)

In accordance with the Scope of Work for the subject project, Moffatt & Nichol (M&N) reviewed pertinent drawings and reports and conducted pier bent mark-out, and topside and underside drone surveys to produce this Memo. The purpose of the Memo is to provide stabilization recommendations for the area affected by the loss of Pile 45:B. This Memo follows Memo No.1, dated April 17th, 2024, where the damage to the Ocean Beach pier was documented and the overall pier stability was evaluated. Memo No.1 is included in Appendix A. Appendix B contains a copy of Memo No. 2 - Ocean Beach Pier – Updated Condition Investigation and Interim Recommendations. This memo advises as to limited operational restrictions for the pier in its current condition.

Moffatt & Nichol performed pile bent mark-out of the pier deck on March 8th, 2024. Under the direction of M&N, the drone survey was performed by sub-consultant True Image Drone Solutions (TIDS) on March 11th and 12th, 2024 focusing on Bents 10 through 50. An additional survey was conducted on Thursday April 4th after review and assessment of the initial imagery.

Capacity estimation

The Naval Facilities Engineering Command (NAVFAC) has developed an overall condition rating system that provides standard condition rating classifications for all waterfront facilities. In the use of this system, each facility is given an overall rating based on the observed conditions. The six terms used to describe the conditions of a structure are described below and will be used in describing structural elements in this memo. Assignment of the ratings for this investigation are based on initial observations and experience investigating similar structures.

The capacity loss estimate is based on the damage and rating seen in the elements and changes in the designed conditions of the elements.

The condition rating definition used in this memo is as follow:

- **"Good"** – *No problems or only minor problems noted. Structural elements may show some very minor deterioration, but no overstressing observed.*
- **"Satisfactory"** – *Minor to moderate defects and deterioration observed, but no overstressing observed.*
- **"Fair"** – *All primary structural elements are sound, but minor to moderate defects and deterioration observed. Localized areas of moderate to advanced deterioration may be present but do not significantly reduce the load bearing capacity of the structure.*
- **"Poor"** – *Advanced deterioration or overstressing observed on widespread portions of the structure.*
- **"Serious"** – *Advanced deterioration, overstressing, or breakage may have significantly affected*

the load bearing capacity of primary structural components. Local failures are possible.

- **"Critical"** – *Very advanced deterioration, overstressing, or breakage has resulted in localized failure(s) of primary structural components. More widespread failures are possible or likely to occur.*

Capacity estimate - existing structure - Bents 44-47

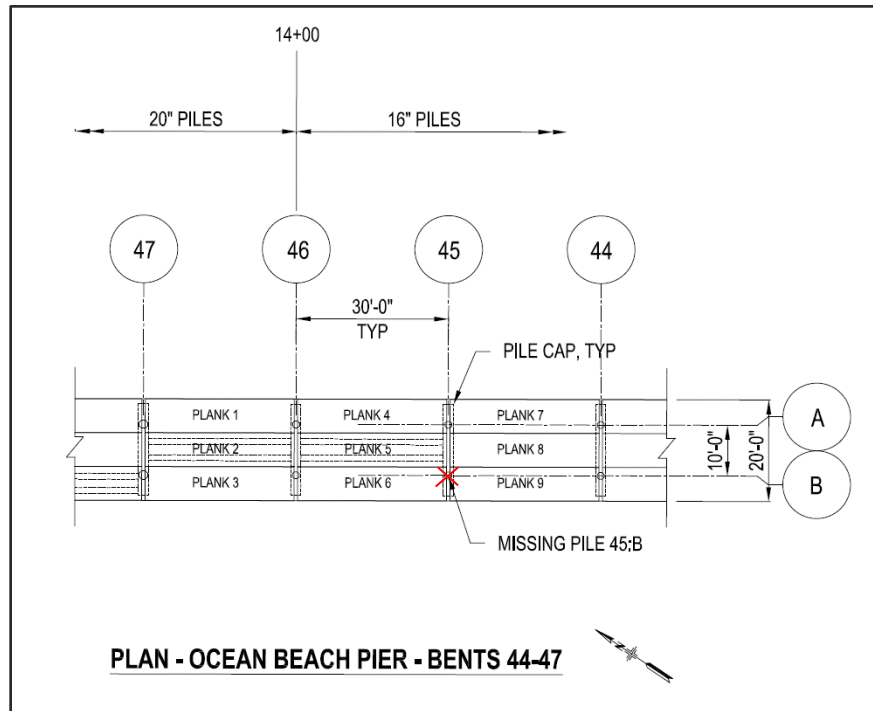

Figure 1: Plan View - Bents 44-47.

The damage rating for each element is given in Table No. 1 below.

Table No. 1 – Conditions Assessment Bents 44 - 47

Structural element	2016 condition	2024 condition	Capacity Reduction	Comment
Pile 44:A	Fair	Fair	20%	Pile is subjected to additional axial load due to the adjacent missing pile. Minor defects noted.
Pile 44:B	Fair	Fair	20%	Pile is subjected to additional axial load due to missing pile. Minor defects noted.
Pile 45:A	Fair	Fair	80%	Eccentric loading and additional axial load due to missing pile. Minor defects noted.
Pile 45:B	Fair	Critical	100%	Pile missing
Pile 46:A	Fair	Fair	20%	Pile is subjected to additional axial load due to missing pile. Minor defects noted.
Pile 46:B	Fair	Fair	20%	Pile is subjected to additional axial load due to missing pile. Minor defects noted.
Pile 47:A	Fair	Satisfactory	10%	Minor defects noted.
Pile 47:B	Fair	Satisfactory	10%	Minor defects noted.
Pile Cap 44	Poor	Poor	30%	Closed corrosion spalls are noted on the east, west and bottom sides.
Pile Cap 45	Poor	Critical	90%	Fifty percent missing. Acting as cantilever. Top reinforcement fully exposed and corroded in the east side.
Pile Cap 46	Poor	Poor	30%	Closed corrosion spalls are noted on the east and west sides. The bottom side displayed an open corrosion spall with exposed reinforcement.
Pile Cap 47	Poor	Fair	20%	Open corrosion spall observed on the south side. East side shows signs of cracks at cold joint.
Plank & Deck 1	Fair	Fair	10%	Open corrosion spalls noted at east and west sides next to pile caps, with exposed strands.
Plank & Deck 2	Fair	Fair	10%	Open corrosion spalls noted at south edge at the middle of the plank, with two exposed strands.
Plank & Deck 3	Fair	Fair	10%	Open corrosion spalls noted at east edge next to pile cap.
Plank & Deck 4	Fair	Poor	20%	Open corrosion spalls noted at east edge next to pile cap.
Plank & Deck 5	Fair	Serious	80%	Loss of Support at Bent 45
Plank & Deck 6	Fair	Critical	90%	Loss of Support at Bent 45
Plank & Deck 7	Fair	Poor	40%	Open corrosion spalls with exposed strands (estimated over seven strands) are located at the east side where it meets Bent 44.
Plank & Deck 8	Fair	Serious	80%	Loss of Support at Bent 45
Plank & Deck 9	Fair	Critical	90%	Loss of Support at Bent 45

The images derived from the drone survey indicate that the condition assessment for Bent 45 is critical. Bents 44 and 46 display signs of poor-to-fair condition for the various components of the structure. The ratings are based on potential overstress on those elements due to the missing Pile 45:B, where redistribution of loads through the concrete topping modifies the conditions for which these elements were designed. Refer to Appendix A for additional information and supporting images.

Capacity estimate – Overall pier structure - Bents 1-44

As indicated previously, the drone survey shows areas of significant damage to the piles, pile caps and soffits - see Appendix A. The piles were in fair-to-good condition. Open corrosion spalls were found in Pile 15:B. Capacity loss for Pile 15:B is estimated to be 20% for gravity demands. In general pile caps were in poor condition, with some being in a serious condition.

Due to proximity to the unsupported expansion joint at Bent 38, and the advanced state of the corroded reinforcement at the pile cap at Bent 39, this location is flagged as “serious”. An estimate of 30% loss of capacity at Bent 39 is given for gravity demands. For waves acting with uplift forces, the reduction is estimated to be 60%. For the soffit, as indicated in the 2016 report, the precast pre-tensioned concrete planks were in fair condition, except from the pile cap at Bent 36 to the pile cap at Bent 37 where the soffit is in poor-to-serious condition. This area has the worst exposure to salt water due to wave action.

In these areas some of the precast pre-tensioned planks have open corrosion spalls with exposed strands, and lost strands due to the corrosion. In the span between Pile Cap 31 and 32, some of the strands have corroded to the extent that the full section of the strand has been lost in the south plank at the west support. Similar damage was encountered between Pile Caps 28 to 31. This area is flagged as a serious condition, with an estimated loss of capacity of 60% for gravity demands.

Stabilization concepts

The requirement for stabilization is related to the ability to tolerate risk. The need for emergency stabilization is less compelling because the pier is shut down to public access. As mentioned in Memo No. 1, it may be prudent to stabilize questionable areas to 1) prevent potential successive collapse of adjacent pier bents in heavy storms and 2) prevent material from falling into the ocean that will have to be retrieved later. The areas underneath the pier that are on dry land or over relatively shallow water are more of a concern because of the difficulty restricting public access. The condition of the pier deck and substructure in these areas are in good condition because the deck components are up and out of the splash zone. The following are concepts that merit consideration:

- **"Do nothing"**. This is the default option when the potential for failure is considered minimal or tolerable because it will not cause public safety concerns. As indicated in Memo No.1, the possible collapse of the affected areas is higher during the storm season. If the unsupported planks at Bent 45 collapse, portions of the planks will fall into the water and/or may impact adjacent piling. The second scenario will cause further damage to the adjacent inboard bents and could cause additional loss of piling. Due to the distance between the failed Pile 45:B and the shore, no threat to public safety is of concern if the pier remains closed and the public remains beyond 75 ft of the pier. Fallen debris would need to be retrieved off the ocean bottom during the pier replacement project. See additional discussion regarding debris at the end of this memo.
 - **Description of collapse scenario.** Under the “do nothing” alternative, it is conceivable that Pile 45:A - located opposite the missing pile - could fail in a significant storm due to the increased vertical and eccentric load. This would also be the case where the pile and pile cap at Bent 39 are potentially compromised - see Appendix A. Should a second pile fail opposite the missing pile, there would be continued redistribution of load due to the composite action of the plank and the concrete topping. At some point, it is entirely possible that the planks framing into the bent having two lost piles will fail and drop into the water. Even in large storm events, it is expected that lost piling, pile cap and deck structure would fall to the ocean bottom in fairly proximity to the pier footprint due to the density of the concrete.

- **"Selective demolition"**. This typically involves saw cutting and removing portions of the structure with questionable structural integrity. Limits to the recommended demolition work are shown in Figure 2, and 3. This solution alleviates the additional axial and eccentric loads currently attributed to Pile 45:A. Deck removal reduces the additional load imposed on the adjacent bents.

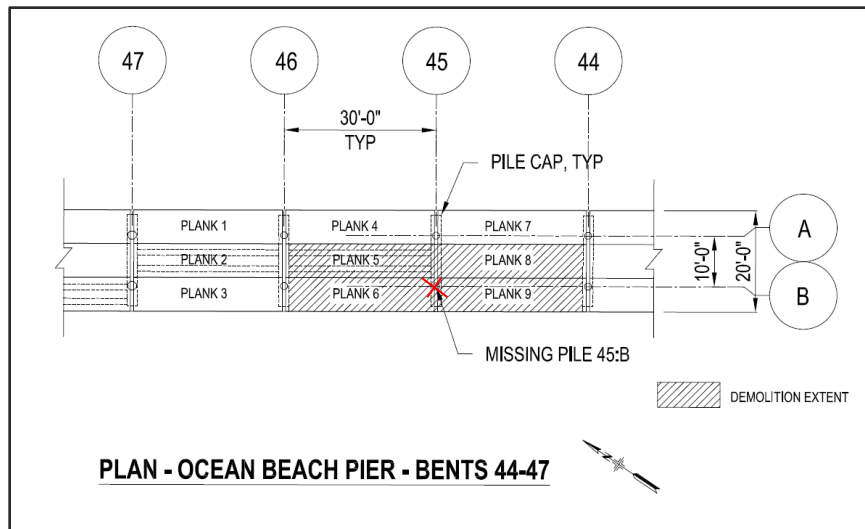

Figure 2: Plan View- Bent 44 to 47 proposed demolition extents.

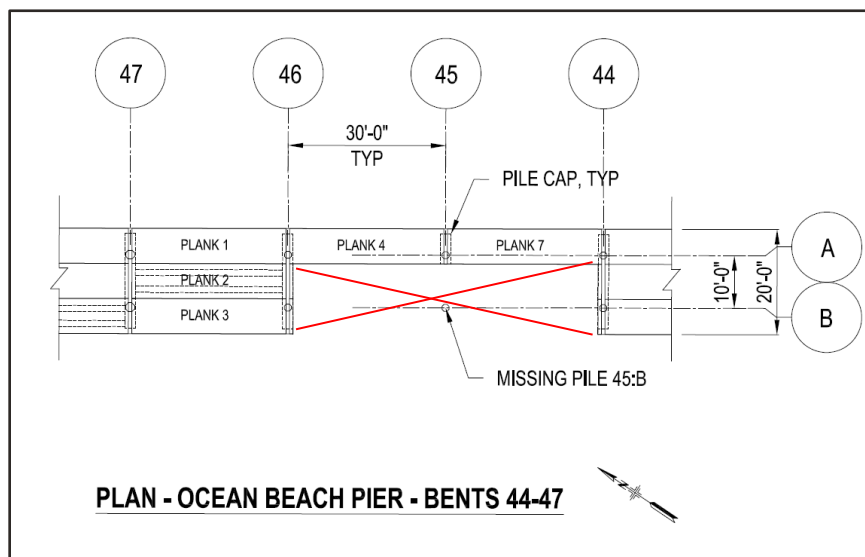

Figure 3: Plan view - Bents 44 to 47 after deck removal.

- Pros and cons of the recommendation:
 - (Pro) This is a straightforward solution that removes the affected deck elements where there is a loss of support.
 - (CON) Discussions with contractors were undertaken to review possible solutions for removing the deck panels. Removal of the saw-cut panels by helicopter would be the preferred due to imposed weight restrictions of the deck. Research of available helicopters determined that helicopters having sufficient listing capacity (22,000 pounds) are not readily available. The potential for demolishing deck using smaller

sawcut pieces was considered but it was not considered viable due to worker safety. Another alternative from the discussion was to sawcut the panels, allow them to fall into the ocean, and then retrieve the debris from the ocean bottom. This alternative was disregarded due to environmental concerns that might be triggered by the different agencies.

- **(CON)** Due to proximity to the expansion joint at Bent 38, removing the deck panels between Bent 44 and 46 could weaken the overall structure from a lateral load perspective (large waves). Additional diaphragm loads must be carried through Plank Nos. 4 and 7, as indicated in the figures above, which would overstress the remaining deck elements
- **"Cable Support"** The proposed alternative is a low-cost means of stabilizing the planks numbered 5-6 and 8-9 for vertical load as shown in Figure 1. This alternative considers introducing cable to support the deck panels, like a suspension bridge. The deck would be supported by cables threaded through either eyebolts anchored to the deck or cables connecting transversely to the longitudinal cables. Figure 4 shows the first alternative with eyebolts and a toggle bar anchored to the deck. An important note is that the anchors at the end of the cables will see substantial loads. Using multiple cables to reduce the load or providing a plate at the top and bottom of the deck to rely on bearing would be necessary.

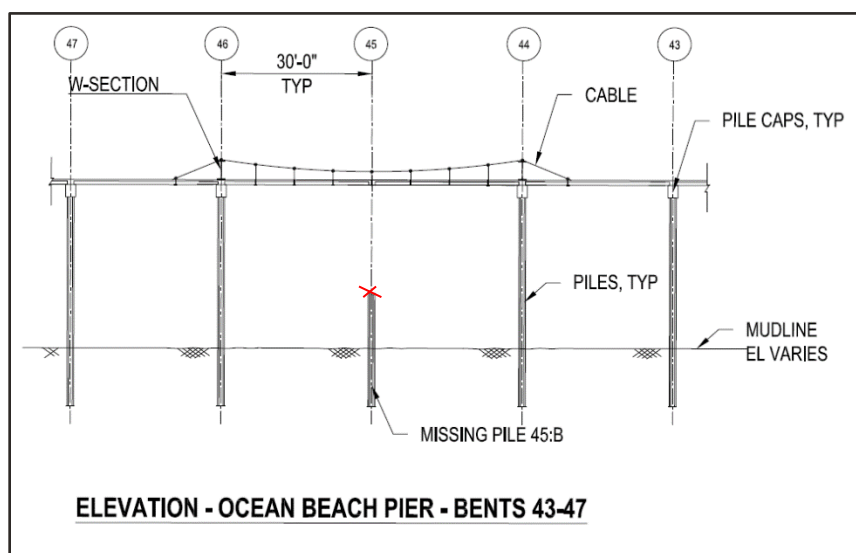

Figure 4: Elevation - Bent 43-47- Cable Support

- Pros and cons of the recommendation:
 - **(PRO)** Inexpensive solution.
 - **(CON)** There are safety concerns about anchoring the cables to the deck panels. If a toggle bar with eyebolts connected to the deck is elected, coring into the unsupported planks would be, necessitating required additional measures (falsework or shoring) for the workers to perform the work safely and adding to the total cost of this alternative.
 - **(CON)** This option only provides support for gravity loads. Thus, under storm events, if the deck panels experience overtopping, this stabilization measure will not accommodate wave-induced uplift forces.

- **"Remain-in-place strongback support"**. This technique is commonly used to provide interim shoring for damaged structures. The concept involves introducing structural members that have the capacity to span under or over areas of damage and reinstitute support using alternate load paths.

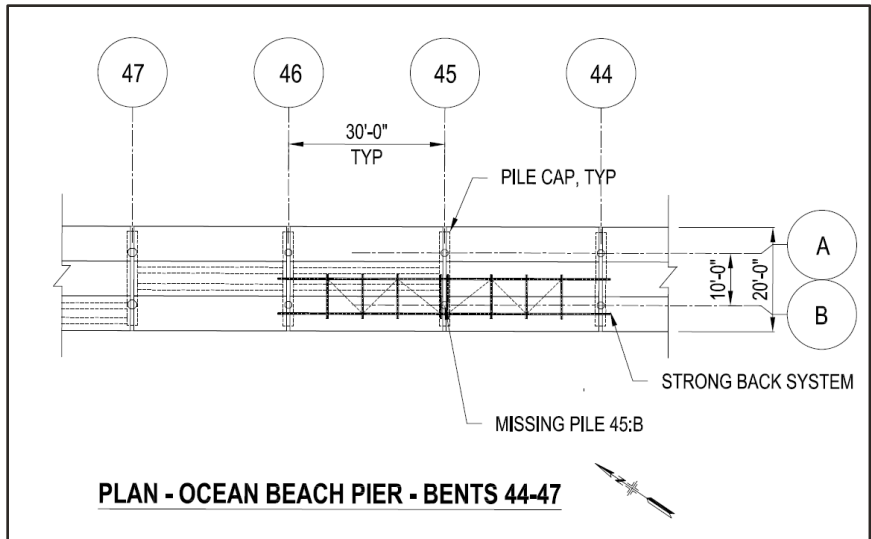

Figure 5: Plan view - Bents 44 to 47 with strong back system.

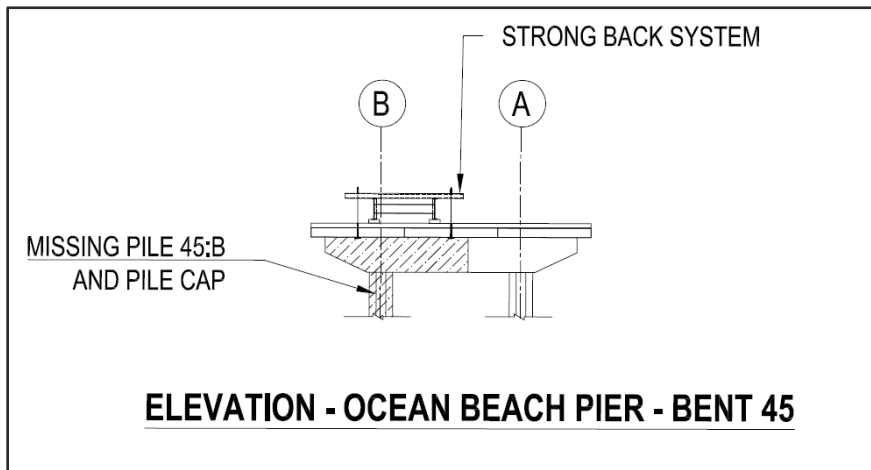

Figure 6: Elevation - Bent 45 with strong back system.

- Pros and cons of the recommendation:
 - **(PRO)** Implementation of this approach can provide a safe platform for workers to work over the affected area without fear of collapse.
 - **(PRO)** This solution provides uplift support. It can be designed to provide support during storm events.
 - **(CON)** Expense - This solution is more expensive than cable support.

Interim stabilization contractors

Consultation was held with three different contractors having experience working in the marine environment. These discussions produced mixed results. Each contractor was presented with the four alternatives described above and appreciated the difficulties and complexities of the effort required and the precautions necessary to execute the work safely. A summary of contractor contacts and discussion follows:

- Jeannette Company Inc.

Contact information:

*Jennette Company, Inc.
Jennette, Brian J.
7847 Dunbrook Rd., Ste "C"
San Diego, CA 92126
Mobile: (858) 583-2893
Email: brianj@jennettecompany.com*

Jennette Co. declined to propose due to safety considerations.

- Reyes Construction Inc.

Contact information:

*Reyes Construction, Inc.
Leathers P. E., Steve
1383 S. Signal Drive
Pomona, CA 91766
Bus: (909) 622-2259
Mobile: (714) 900-0208
Email: sleathers@reyesconstruction.com*

Reyes Construction declined to propose due to safety considerations.

- Power Engineering and Construction Co.

Contact information:

*Power Engineering Const. Co.
Mik, David
1501 Viking St., Suite 200
Alameda, CA 94501
Bus: (510) 337-3800
Mobile: (415) 559-0097
Email: MIK@PowerEngConstruction.com*

Power Engineering agreed to provide a proposal to the City and negotiate fees to perform emergency stabilization using the strongback method.

Stabilization considerations

Reference is made to the damage described at Pile 45:B and Bent 39 in Memo No. 1. Should the City decide to pursue a stabilization solution, it is recommended that the “remain-in-place strongback support” method be utilized. The approximate cost for executing this work is \$550,000.00 total for both locations. See the estimate provided in Appendix C. At the City’s request, Moffatt & Nichol can arrange an exploratory discussion between the City and Power to help expedite the process.

Existing Debris

Stabilization concepts aside, the status of the debris resulting from the failure of the portions of pile and cap that have been lost at Grid 45:B should be considered. This debris consists of a portion(s) of the pile cap and pile that broke away from the pier during late December/early January storms and are now resting on the ocean bottom. In addition, there may be a portion of Pile 45:B extending-up from the ocean floor - the exact elevation of the top of the pile remnant is not currently known.

The City could consider, the remaining pile stub extending-up from the ocean floor should be inspected below water to ensure that the stub is not a potential threat to vessels or surfers navigating in the vicinity of the pier. For a complete description of the debris, reference pages 4 - 6 of the April 17, 2024 “H2225961 Ocean Beach Pier 2024 Assessment – Emergency Memo (Memo No. 1).”

This debris consists of reinforced concrete and qualifies as inert waste – meaning “a subset of solid waste that does not contain hazardous waste or soluble pollutants at concentrations in excess of applicable water quality objectives and does not contain significant quantities of decomposable waste.” The current plan for managing this material is to dispose of it as part of the overall demolition of the existing pier associated with the construction of the new pier being designed as part of the “Ocean Beach Pier Renewal” project.

The City should consider approaching the US Army Corps of Engineers (Corp) and the California Coastal Commission (CCC) to gain the concurrence of both agencies regarding the removal of the fallen concrete debris as described above. Moffatt & Nichol can facilitate discussions with these agencies (with the City being a participant) at the City’s request.

Should it be necessary to remove the concrete debris from the ocean floor prior to the Ocean Beach Pier Renewal Project, the following concepts should be considered:

- The work would be located directly in the vicinity of the missing pile. In its current condition, the pier cannot support crane and debris removal operations.
- The work will have to be performed from a derrick crane barge or similar vessel with sufficient crane capacity to pick up the concrete debris. Commercial diving operations would be used to confirm the debris location and facilitate removal.
- To accommodate barge and diver operations, the ocean swells in the vicinity of the pier will need to be limited to a maximum of 2 ft in height.
- The exact locations of the debris are not currently known. The debris will have to be located by use of divers or a multibeam bathymetric survey.
- After removal of the missing portions of the pile and cap, the remaining portion of pile 45:B extending up more than 1 ft. above the ocean floor should be cut-off and removed.
- The concrete debris should be disposed of at a landfill approved by the City.
- The approximate cost for the work described above \$150,000.00, is itemized as follows:
 - Mobilization and demobilization \$70,000.00
 - Bathymetric Survey \$11,000.00
 - Recover and dispose of pile and debris..... \$40,000.00
 - Cut and dispose of Pile 45:B..... \$29,000.00

--End--

Appendix A

- H2225961 Ocean Beach Pier 2024 Assessment – Emergency Memo (Memo No 1)

MEMORANDUM

To: Delfa Genova, P.E.

From: Matthew Martinez, S.E., *M.M.* Valentina Vasquez Rossier, P.E. *V.V.R.*

Date: April 17th, 2024

Subject: H2225961 Ocean Beach Pier 2024 Assessment – Emergency Memo (Memo No. 1)

In accordance with the Scope of Work for the subject project, Moffatt & Nichol (M&N) reviewed pertinent drawings and reports and conducted pier bent mark-out, and topside and underside drone surveys in order to produce this Memo. The purpose of the Memo is to document a rapid evaluation of the pier structure to assess emergent damage from the recent storms and evaluate overall pier stability. Following the drone survey, an initial damage assessment resulting in identification of areas of potential pier instability was developed.

Moffatt & Nichol performed pile bent mark-out of the pier deck on March 8th, 2024. Under the direction of M&N, the drone survey was performed by sub-consultant True Image Drone Solutions (TIDS) on March 11th and 12th, 2024 focusing on Bents 10 through 50. An additional survey was conducted on Thursday April 4th after review and assessment of the initial imagery.

DESCRIPTION OF FACILITIES

The Ocean Beach Fishing Pier is located in the City of San Diego at the western end of Niagara Street. The pier was opened in 1966. The main portion of the pier is 2,022 ft long and extends in a northwesterly direction from the shore. Two legs extend in northerly and southerly directions, forming a tee at the outboard end of the pier. The north leg is 193 ft long, and the south is 368 ft long. Most of the pier deck is 20 ft wide.



Photo 1: Ocean Beach Pier Aerial looking south.

The pier structure consists of concrete topping placed over prestressed concrete deck panels, as shown in Figure 1. The deck panels span between concrete pile caps supported by prestressed concrete piling. A timber railing is located around the entire perimeter of the pier. The railing on the north side of the pier supports potable water, sewer, natural gas, and electrical utility lines.

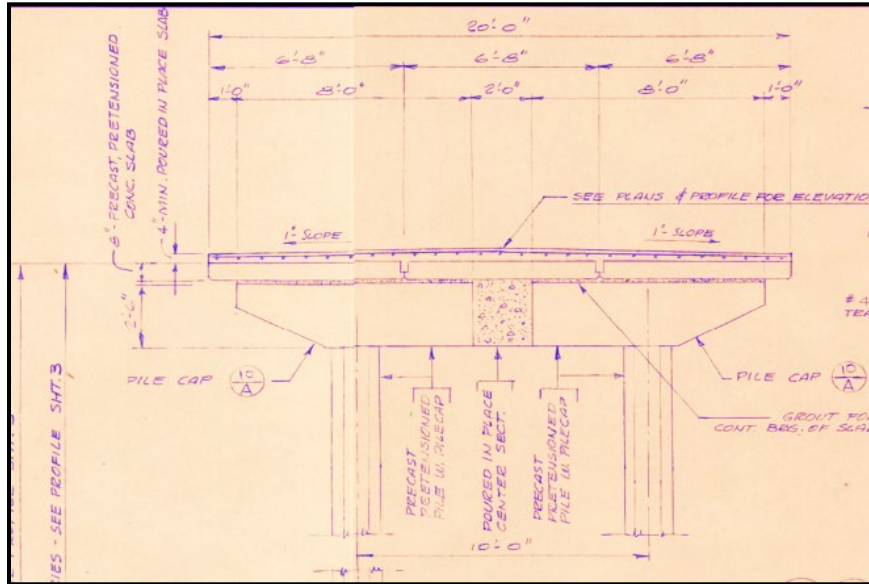

Figure 1: 1966 Record Drawing – Typical pier section at pile cap.

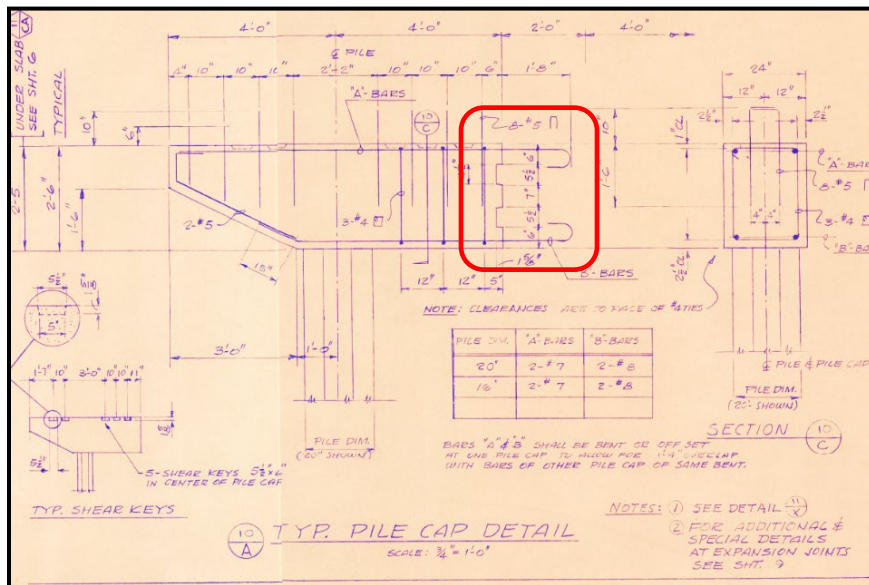

Figure 2: 1966 Record Drawing – Dowel reinforcement at the cold joint (red rectangle) of the hammerhead pile cap.

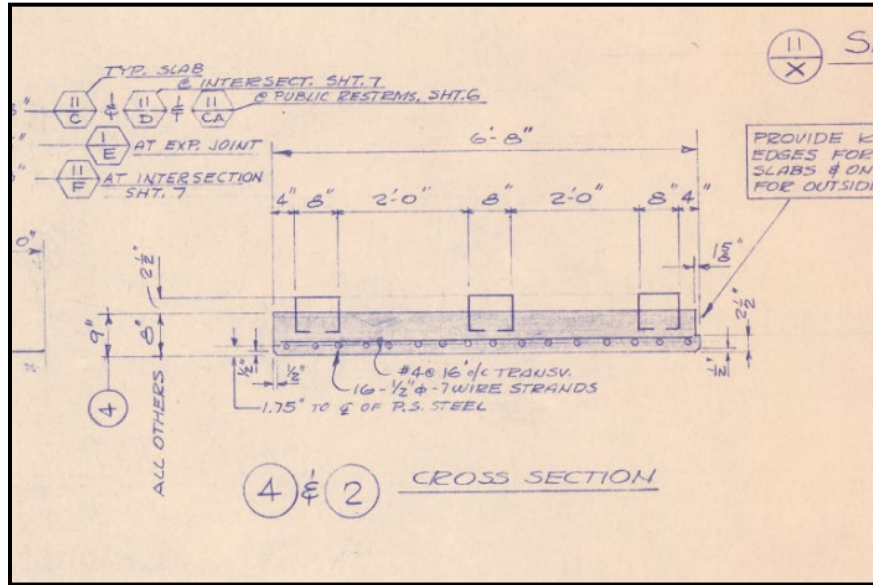

Figure 3: 1966 Record Drawing: Precast plank typical cross-section at 30ft spans.

SIGNIFICANT DAMAGE AND CONDITION ASSESSMENT

Pile cap and Pile at 45:B - A storm on December 28th-29th, 2023 (See Photo 2 and Photo 3) resulted in broken Pile 45:B and loss of one-half of the pile cap above. The location of the aforementioned Pile 45:B is shown in a Google Earth image in Figure 4. A previous inspection performed during May 2023 shows corrosion at the top of the pile cap connection to the planks and cracks along the cold joint. No reference to damage or cracks in Pile 45:B was found in the previous report. See Photo 5 for the pile cap images taken during 2023.



Figure 4: OB Pier Aerial Image showing the missing Pile 45:B.



Photo 2: December 28th-29th, 2023, storm event impacting the OB Pier. Note that the broken wave overtops the pier and completely engages the underside of the deck and pile cap.

Careful examination of the above deck area directly over the missing pile (see Photo 20) found no excessive cracking or displacement of the cast-in-place concrete topping attributable to the loss of the pile.

As follow-on assessment the following incremental steps are proposed as cause for the current condition at Grid 45:B.

- Large waves from the aforementioned storm were known to reach the underside of the deck at a location close to the deck low point on the pier. The waves created uplift pressure on the deck (see discussion regarding Bent 38 below).
- This large wave force impacted the pile cap at Bent 45. This pile cap was already heavily damaged due to corrosion of reinforcing steel as shown in Photo 5.
- The wave force impacting the pile resulted in separation of the precast portion of the pile cap over Pile 45: B. This left the pile resisting force in inverted pendulum fashion due to the weight of the pile cap supported by the unbraced pile. Photo 3 shows the pile having been broken off somewhere above the high tide line - an area commonly known to have increased “splash zone” corrosion to the internal prestress strands and reinforcement.
- Subsequent photos show the pile missing above water altogether. This means the pile has either:
 - Broken off somewhere further down in the water column.
 - Broken at a point of fixity below the sand. The remaining pile stub could be projecting upwards at an angle below water or may have fallen over completely and is lying on the seafloor.



Photo 3: December 28th-29th, 2023 storm event. Pile 45:B broke (red circle) above the waterline pile cap broken shown in dashed red lines.

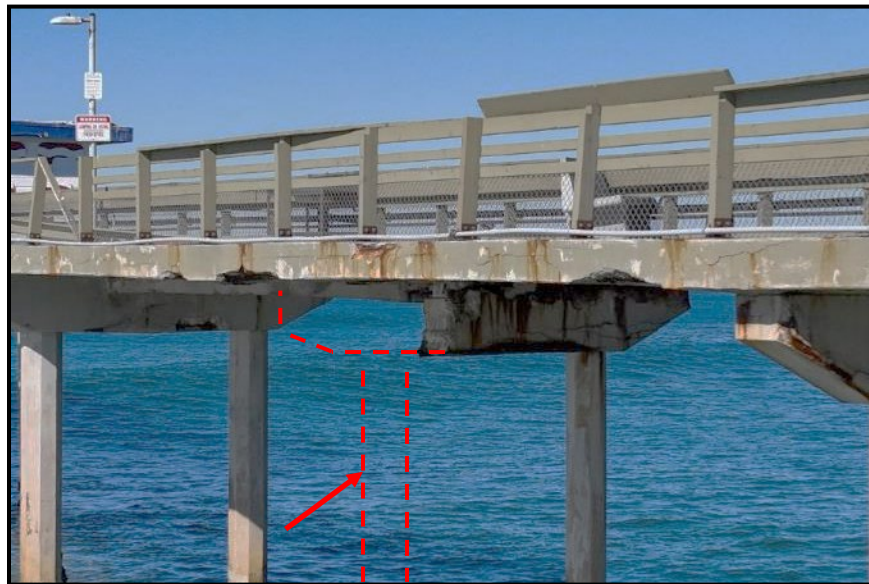

Photo 4: Bent 45 looking north. The dashed lines show the missing pile and pile cap at Pile 45:B.



Photo 5: Bent 45 May 2023 visual inspection Dashed lines show assumed pile cap "break-away" location from pier deck.

Pile cap at Bent 39 – A similar condition to what was survey at Bent 45 during the 2023 assessment was encountered at Bent 39. Photo 6 through Photo 9 show the existing condition at the pile cap. The pile cap has a crack at the cold joint that goes from one face to the other with broken bottom reinforcement at the cold joint. Photo 6 and Photo 5 show the pile cap looking east and west, respectively. A red segmented line points to the crack at the cold joint. This condition is very similar to the condition found at the failure plane at Bent 45 as seen in Photo 4 and Photo 5.

Additionally, open corrosion spalls at the top of the southern face show exposed reinforcement and lost dowel reinforcement connection, see red arrows at Photo 8 and Photo 9. The dowel connection is shown in Figure 2 of the record drawings, as 8-#5 at each hammerhead.

If the pile cap failure mechanism described for the pile cap at Bent 45 should occur at Bent 39, the resultant damage could be more significant than at Bent 45. This is because of the loss of plank support at the expansion joint, see the discussion at Expansion joint damage.



Photo 6: Bent 39 looking east. In the photo, spalled concrete is noticeable at the pile cap with exposed reinforcement at the top of the pile cap. The red segmented line shows the vertical crack at the cold joint.



Photo 7: Bent 39 looking west. The red segmented line shows the vertical crack at the cold joint.

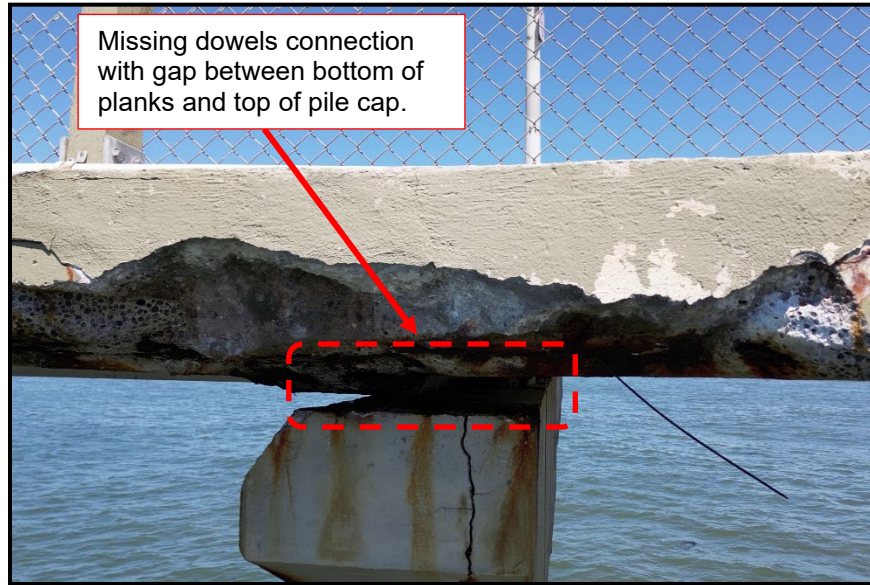

Photo 8: Bent 39 south face of pile cap. The red arrow points to the loss dowel connection between the pile cap and the precast planks.

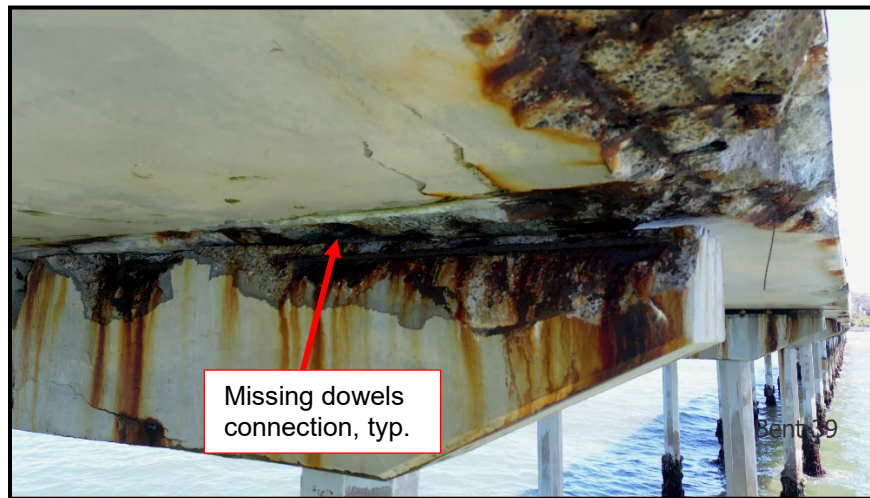

Photo 9: Bent 39 looking east. Close up of spalled concrete and missing dowel connection.

Expansion joint damage - Photo 10 depicts an expansion joint steel plate that has been displaced at Bent 38. A close-up of where the failure was initiated is provided in the same photo. This area corresponds to where the anchor rods failed in their connection to the concrete edge due to the wave pressure uplift acting beneath the pier, or the pounding of the adjacent structural elements.

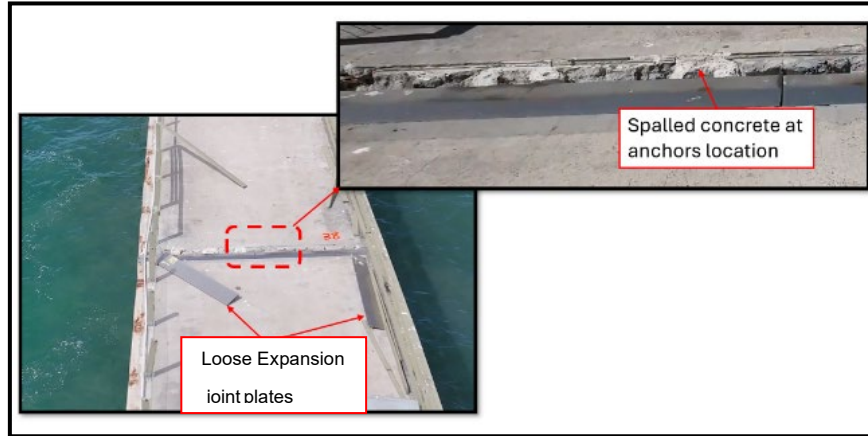

Photo 10: Displaced steel expansion joint plate lost during the storm event.

The concrete damage has resulted in partial loss of vertical support for the prestressed concrete planks on the west side of the expansion joint. The precast planks rest on embedded bearing plates located on the top of the pile cap below the expansion joint (see Figure 5). The embedded concrete anchorage of the bearing plates were already cracked and spalled due to reinforcing steel corrosion-related damage to the concrete.

The uplift pressure from the waves resulted in dislocation and movement of the bearing plates - see Photo 11, Photo 12 and Photo 13 for a closeup of the bearing at the northern , middle and southern precast planks on the west side of Bent 38. The middle of the three prestressed concrete planks has been most affected by this damage (Photo 12 and Photo 14), where it has lost all but one of the supports. Photo 14, shows one displaced bearing at the middle plank that provides partial support. The northern plank has lost three out of five bearing pads, as seen in Photo 11. The fact that the prestressed concrete planks are anchored to the cast-in-place concrete topping allows for some redistribution of vertical loads to the adjacent planks.

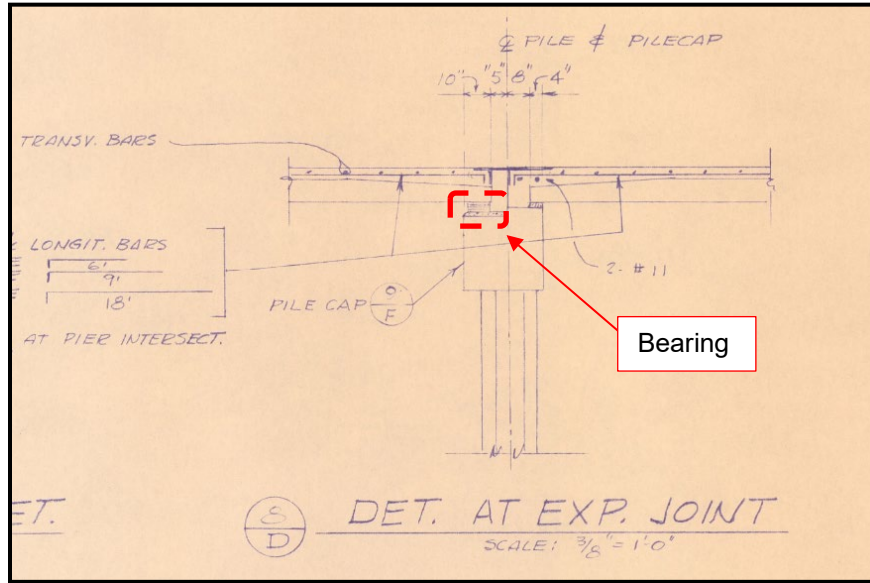

Figure 5: Record Drawing: The arrows point to the bearings shown in the 1966 record drawings.

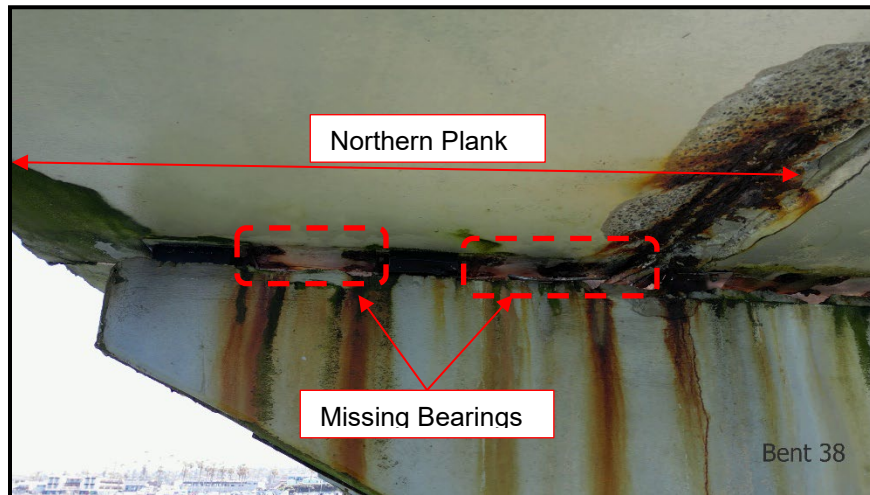

Photo 11: Bent 38 (looking east): northern PC plank, red dashed rectangles point to missing bearing pads.

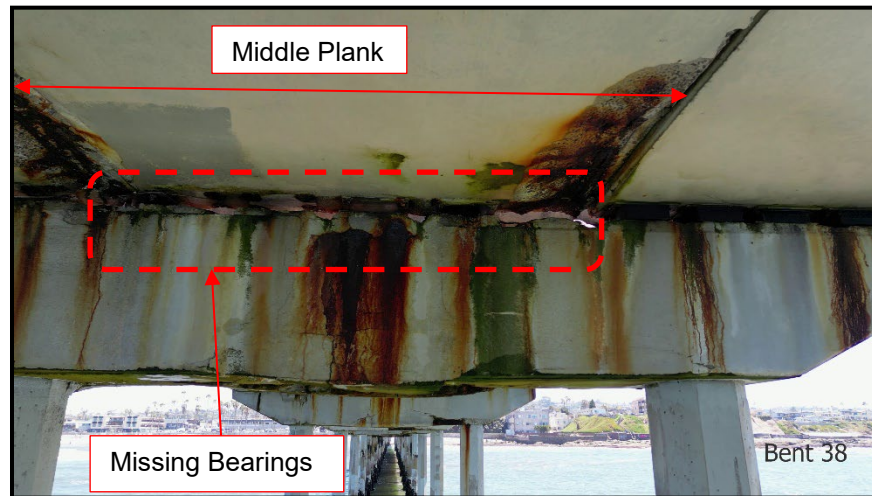

Photo 12: Bent 38 (looking east): middle PC plank, red dashed rectangles point to missing bearing pads.

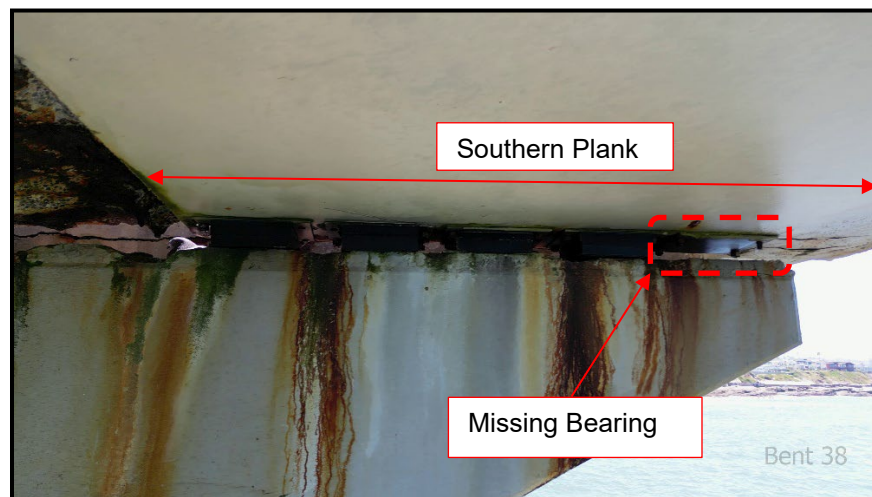

Photo 13: Bent 38 (looking east): southern PC plank, red dashed rectangles point to missing bearing pads.



Photo 14: Bent 38 (looking east): Red arrow point to a displaced bearing at the middle plank that provides partial support.

Due to the damaged condition at Bent 39, if the pile cap failure mechanism described for the pile cap at Bent 45 should occur at Bent 39, the resultant damage could be more significant than at Bent 45. This is because of the loss of plank support at the expansion joint.

Pre-existing concrete damage made worse - Other locations on the pier revealed evidence of the progression of pre-existing concrete damage, i.e., closed corrosion spalls became open corrosion spalls (OCS), existing spalls increased in size, and emergent spalls developed. In general, this increased damage does not approach a level of criticality approaching potential failure. Pile 15:B was identified with an open corrosion spall, as depicted in Photo 15. At the same bent, degradation at the cold joint between the pile caps has been initiated, as shown in Photo 15 and Photo 16.

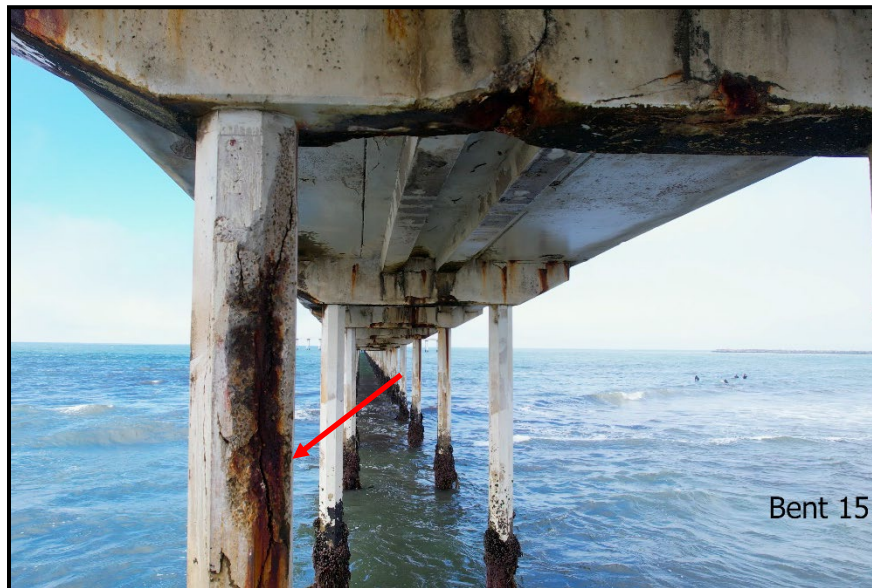

Photo 15: Bent 15 looking west. The arrow points to an open corrosion spall OCS on Pile 15:B.



Photo 16: Bent 15 looking east. The red arrow points to initiation of cracking at cold joint.

Precast planks and Cast-in-Place (CIP) topping damage - open corrosion spalls with corroded strands can be seen throughout the pier, with the highest severity around Bents 28 through 32. These areas are critical when subject to traffic or pedestrian loads (gravity demands). The damage results in reduced vertical load capacity. Capacity reduction is related to the number of strands that are heavily corroded, and the location of the damaged strands on the precast plank. Restrictions on gravity loads will be recommended due to this condition as indicated in the following section.

Photo 17 shows the elevation of Bent 31 looking east, where open corrosion spalls with corroded strands at the southern precast planks are evident. The prestressing strands provide compression to the concrete. Photo 18 and Photo 19 provides images from previous assessments at the same location and allows comparison of the evolution of damage in the area over a period of eight years. During the 2016 survey (Photo 19) the area of spalled concrete was much smaller than the 2023 photo (Photo 18).



Photo 17: Bent 31 An elevation of pile cap at Bent 31 looking east (March 2024). The arrow points to the open spall corrosion with exposed strands at the southern plank.



Photo 18: Bent 31 From May 2023 visual inspection looking north. The dashed line shows the approximate boundary of concrete damage when surveyed in 2016. The arrow points to the open spall corrosion with exposed strands at the southern plank during the 2023 survey.



Photo 19: Bent 31 From July 2016 visual inspection looking north (underdeck spall partially hidden by pile cap).

There are many areas along the edge of the deck on the south side of the pier where open corrosion spalls were observed. These areas would not result in critical catastrophic failure. Loss of concrete mainly impacts the railing anchorage.

Condition Assessment - Additional areas of potential instability will most likely come from future storms. When attempting to develop a scenario to predict where wave-related damage to the piling and superstructure might occur, the following were considered:

- Wave height and wave force.
- Water depth (determines where waves break)
- Water height (tidal elevation plus storm surge).
- Corrosion damage on structure.
- Pier deck and substructure height

When analyzing these factors, the risk of storm damage at the west end of the pier is minimized as a result of the water depth and the pier deck elevation. For the east end of the pier, the water is shallow, so the wave has already broken, and the pier deck elevation is too high, also minimizing the risk of storm damage. In the opinion of the writers, the potential zone where storm-related damage is most likely to occur is between Bents 54 and 26, as shown in Figure 6.

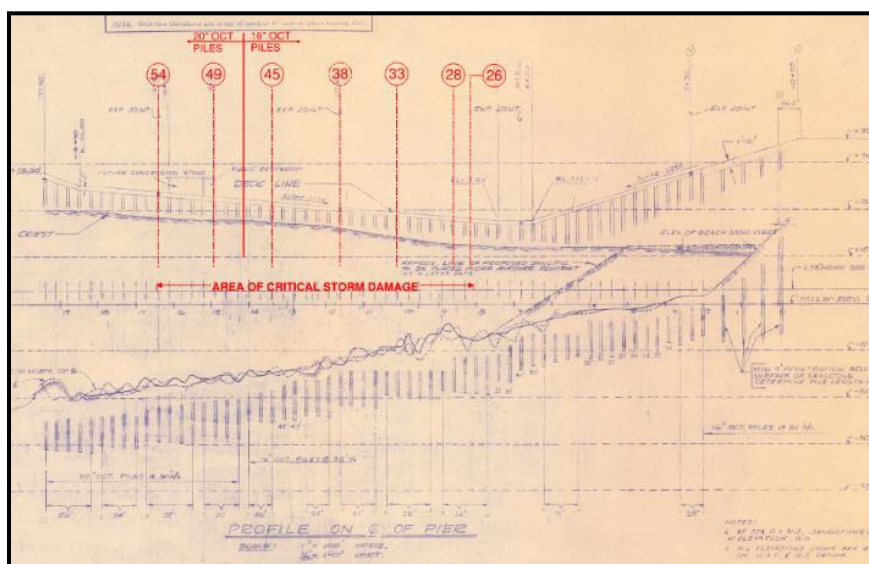

Figure 6: Critical area for storm damage.

The areas in the vicinity of 45, 39, 38, and 15 present areas of potential instability, with the potential loss of Pile 45:B being the most significant. There is a potential of increased damage and pier instability in these areas when subjected to large storm waves and significant earthquakes. The drone survey did not reveal any other locations that have an obvious potential for pier instability at this time.

Should the Ocean Beach Pier Renewal Project go forward, the pier is scheduled to begin demolition in early 2027. Increased storm damage leading to pier instability may occur during the forthcoming winter months until the pier is demolished. If a storm event allows for waves to hit the underside of the unsupported precast planks, there is a significant risk of partial deck collapse near Bent 45 and Bent 39.

If the planks were to fail on one end at Bent 45 and hang from the supported side at the far pile cap (either Bent 44 or 46), this could generate additional surface area for waves to put pressure on the piles at Bent 45 and inboard. This could increase the risk of these piles buckling and promoting a sequential failure of inboard piles and structure.

RECOMMENDATIONS

Loss of Pile 45:B - The potential deck instability above the missing pile poses a threat to public safety. The pier should remain closed unless the pile is replaced, and full deck support is re-established. Enacting this repair is a costly proposition and may not have sufficient merit in light of the proposed pier demolition. Limited pedestrian access beyond Bent 42 and past the missing pile can be permitted for City personnel provided that they access using the “WALK” zones painted on the deck and as shown in Photo 20. No vehicle should transit between Bent 43 and 47.



Photo 20: Walk/No walk demarcation around missing Pile 45:B

Consideration should be given to removing the unsupported portions of the deck or providing temporary support to the planks by other methods to the planks between Bents 44 and 46 since additional damage is expected due to waves impacting the bottom side of the unsupported planks. If the deck fails and portions fall into the water or impact adjacent piling, further damage could occur or, as a minimum, the fallen debris would need to be retrieved off-of the ocean bottom during the pier replacement project. Further consideration of this stabilization effort will be provided as a separate task under the scope of work.

Potential loss of support at Bent 39 - Based on the observed damage, the pile cap at Bent 39 is compromised and shows more damage than what Bent 45 showed during the 2023 visual inspection. The City should consider precautionary stabilization measures for the deck spans between Bents 38 to 40. Future storm events are expected to create additional damage, and due to the close proximity of the expansion joint at Bent 38, if Bent 39 was lost, the damage would be more severe than what happened at Pile 45:B. Further consideration of this stabilization effort will be provided as a separate task under the scope of work.

Vehicular loading - Vehicular traffic up to Bent 38 should be prevented unless strictly necessary. The weight limit for operational vehicles should not exceed three and a half (3.5) tons. As an example, a 3.5-ton vehicle is the equivalent of a Ford F-150 truck with a 1-ton payload. Vehicles should not be parked between Bents 28 and 32, and Bents 14 and 16. Materials should not be stored/placed between Bents 28 and 32, and Bents 14 and 16. Materials placed elsewhere should be well distributed.

The Ocean Beach Pier Renewal project has scheduled geotechnical explorations above the existing pier. These explorations should be restricted up to Bent 28.

Figure 7 indicates the zones on the pier where restrictions are applied. These areas are related to unstable areas, such as Pile 45:B, or where damage to the concrete deck would be expected if gravity loads beyond the restrictions are applied.

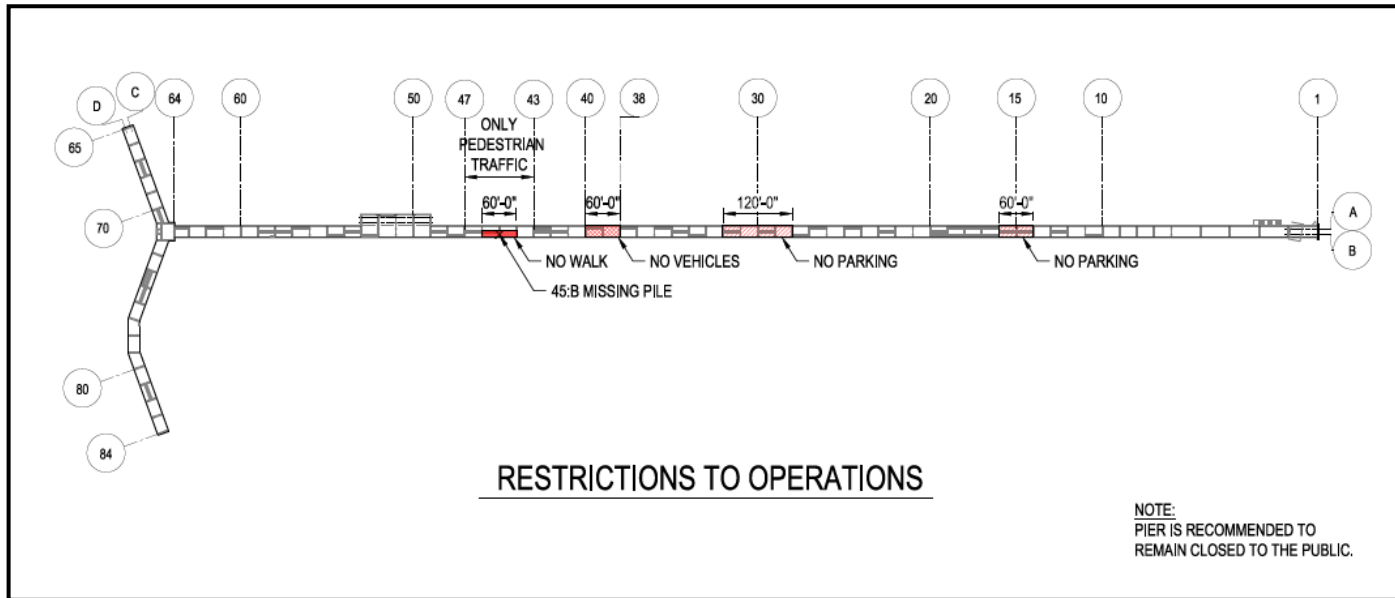

Figure 7: Restrictions on the pier.

Signage at missing pile – Signs should be placed in the vicinity of Bent 45 on both sides of the pier similar to that indicated Figure 8. The sign should be crafted from an easily replaceable material since it is likely that future wave events will result in the need to replace this signage.



Figure 8: Proposed sign near missing Pile 45:B.

Pile 45:B stub - The disposition of the remnant of this pile should be determined. The pile is either laying on the ocean floor, or it remains projecting upward in some fashion so as to be a threat to surfers, swimmers or vessels operating adjacent to the pier. Vessels are expected to be operating to perform geophysical and biological surveys in the relatively near future. An engineer-diver, commercial diver, or a lifeguard dive crew should determine the current status. This could lead to the need for demolition and partial removal of the pile stub.

Attachment A

- Plan View - Ocean Beach Pier - Recommended Restrictions to Operations

FILE NAME: \Users\jgarcia\Documents\SD\2024\04\16\2024-04-16_04-16_RESTRICTIONS TO OPERATIONS - R1.dwg PLOT DATE: Tuesday, April 16, 2024 7:45:50 AM USER: vrasier

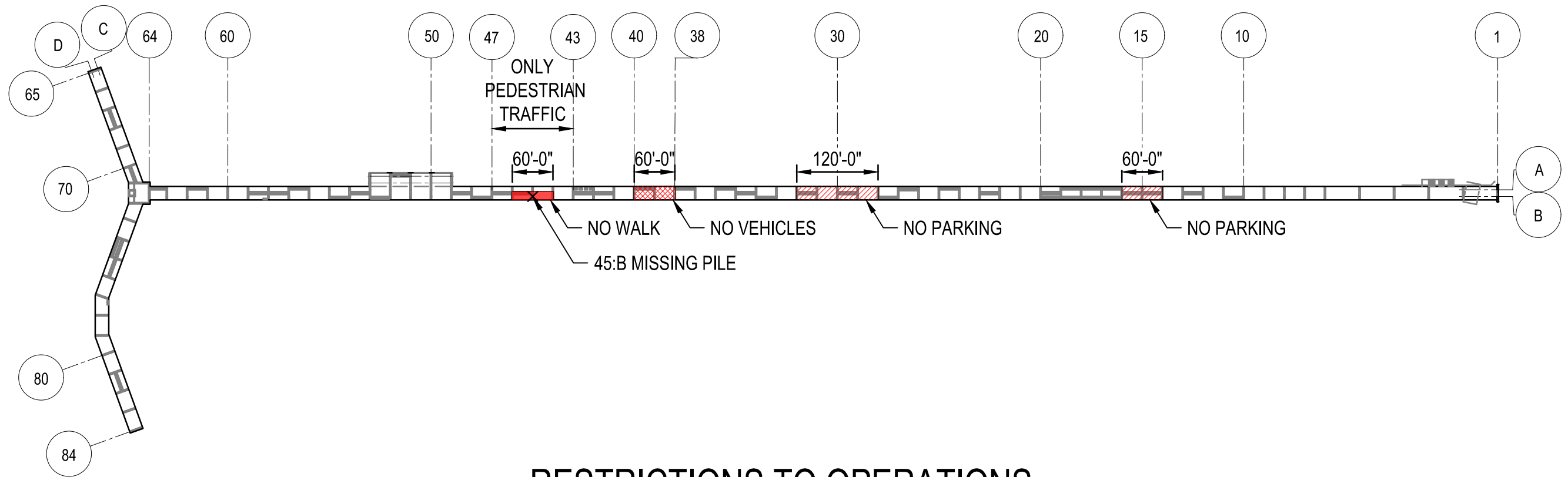

RESTRICTIONS TO OPERATIONS

NOTE:
PIER IS RECOMMENDED TO
REMAIN CLOSED TO THE PUBLIC.

APRIL 16, 2024

**OCEAN BEACH PIER 2024 ASSESSMENT
RESTRICTIONS TO OPERATIONS**

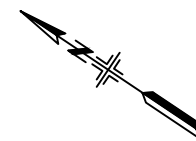

1660 HOTEL CIRCLE NORTH, SUITE 500
SAN DIEGO, CALIFORNIA 92108
PHONE: (619) 220-6050
FAX: (619) 220-6055



Fig. No. **FIG. 1**

Appendix B

- H2225961 Ocean Beach Pier 2024 Assessment – Recommendations for City Staff to Modify Interim Recommendations (Memo No 2)

MEMORANDUM

To: Delfa Genova, PE
From: Matthew N. Martinez, SE *M. M.* and
Valentina Vasquez Rossier, PE *V.V.R.*
Date: April 24th, 2024
Subject: H2225961 Ocean Beach Pier 2024 Assessment – Recommendations for City Staff to Modify Interim Recommendations (Memo #2)

In accordance with the Scope of Work for the subject project, Moffatt & Nichol (M&N) reviewed pertinent drawings and reports and conducted pier bent mark-out, as well as topside and underside drone surveys, in order to produce this memo. The City requested recommendations from Moffatt & Nichol for changes to the July 7th, 2022, memorandum prepared by the City of San Diego titled *Ocean Beach Pier – Updated Condition Investigation and Interim Recommendations*. This in response to the significant wave events during an extreme high tide in mid-October 2023, late December 2023, and early January 2024. As a result, the obvious storm-related damage was the loss of the upper portion of Pile 45:B and the south portion of the pile cap above the pile.

DESCRIPTION OF FACILITIES

The Ocean Beach Fishing Pier is located in the City of San Diego at the western end of Niagara Street. The pier was opened in 1966. The main portion of the pier is 2022 ft long and extends in a northwesterly direction from the shore. Two legs extend in northerly and southerly directions, forming a tee at the outboard end of the pier. The north leg is 193 ft long, and the south leg is 368 ft long. Most of the pier deck is 20 ft wide.

RECOMMENDATIONS

The aforementioned memorandum dated July 7th, 2022 has an introductory paragraph that references the previous visual inspection. The subject memo needs to be updated to reflect the current condition of the pier and the most recent inspection dates. Sample text to be considered is presented below:

As requested, the Engineering and Capital Project Department has obtained the services of a structural and marine engineering consultant to evaluate the current condition of the pier. As part of the ongoing monitoring of the pier, Moffatt & Nichol's subconsultant, True Image Drone Solution, conducted a drone survey between March 11th and April 4th, 2024. The survey consisted of obtaining visual footage of the below deck portion of the pier, the topside of the deck and railings, and images from ten piles. The results of this inspection were compared to the previous data to determine the changes in the condition of the pier. The following interim changes to the pier's operations replace the direction issued on the memorandum dated May 17th, 2023:

The following guidance is suggested:

1. The pier should remain closed to the public due to the lost pile at Bent 45:B.

2. Vehicular traffic up to Bent 38 should be prevented unless strictly necessary. Prohibit the use of heavy equipment or vehicles larger than a ½-ton truck (equivalent to a standard Ford F-150 truck with a 1/2-ton payload) in all areas of the pier, except as noted. Avoid stacking large concentrations of material, including construction materials, anywhere on the pier.
3. Prohibit vehicular traffic beyond Bent 38.
4. Prohibit pedestrian transit in areas marked as “NO WALK” between Bent 44 and 46; see Photo 1.
5. Prohibit vehicle parking and avoid concentrations of pedestrians in areas with severe structural deficiencies. Attachment A identifies the location of the most critical areas in red. M&N recommends that appropriate signage and/or other deck markings be placed in the corresponding areas to restrict vehicular and pedestrian usage at this location.
6. Provide signage at the sides of the pier at the missing pile, see Figure 1. The disposition of the remnant of Pile 45:B should be determined. The pile is either laying on the ocean floor, or it remains projecting upward in some fashion so as to be a threat to surfers, swimmers or vessels operating adjacent to the pier. An engineer-diver, commercial diver, or a lifeguard dive crew should determine the current status.

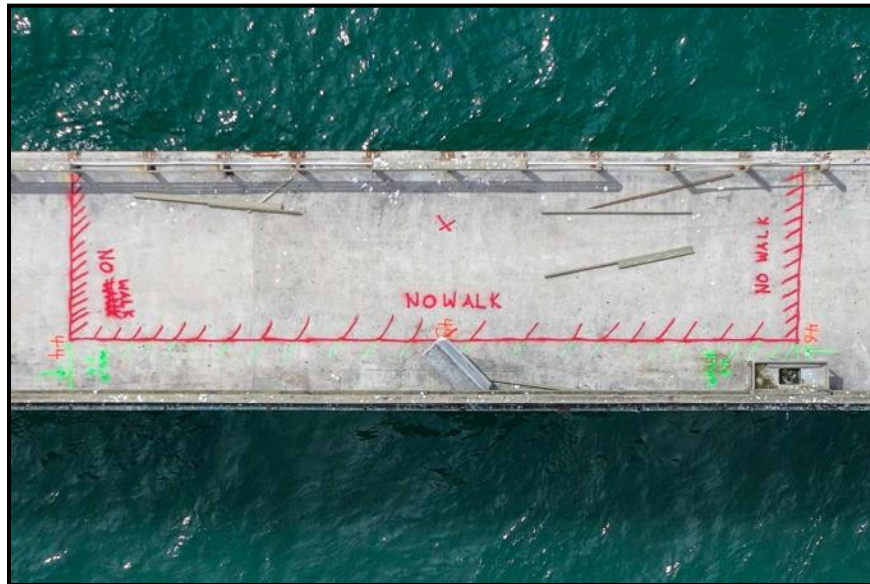

Photo 1: Walk/No walk demarcation around missing Pile 45:B.



Figure 1: Proposed sign near missing Pile 45:B.

Attachment A

- Plan View - Ocean Beach Pier - Recommended Restrictions to Operations

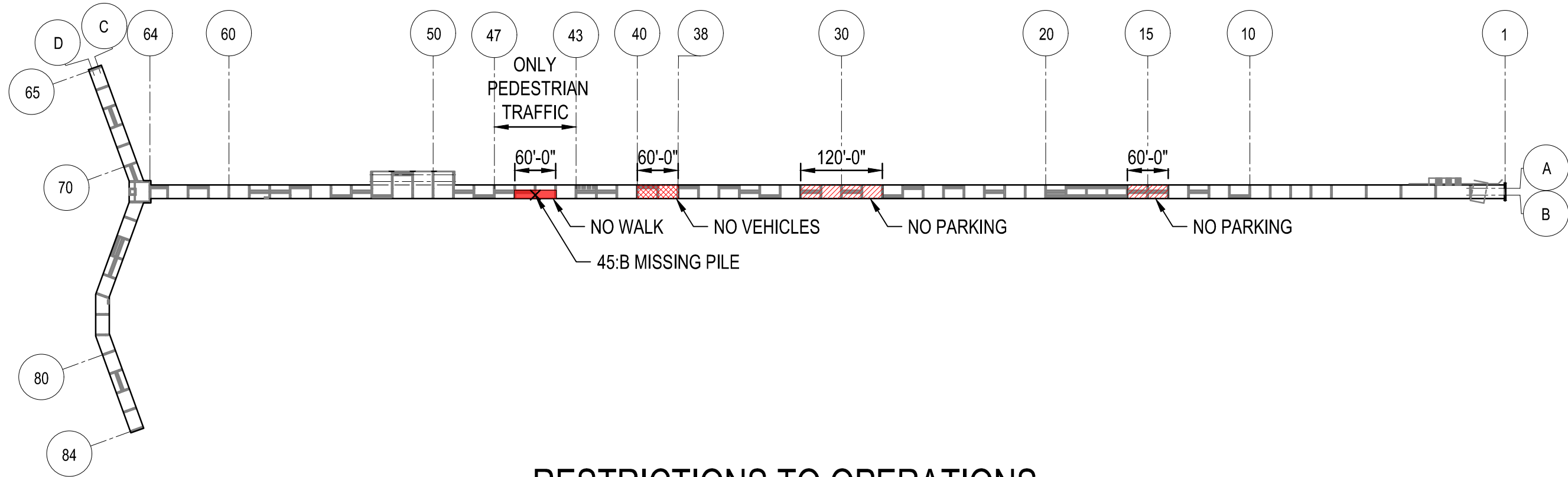

RESTRICTIONS TO OPERATIONS

NOTE:
PIER IS RECOMMENDED TO
REMAIN CLOSED TO THE PUBLIC.

APRIL 16, 2024

OCEAN BEACH PIER 2024 ASSESSMENT
RESTRICTIONS TO OPERATIONS



1660 HOTEL CIRCLE NORTH, SUITE 500
SAN DIEGO, CALIFORNIA 92108
PHONE: (619) 220-6050
FAX: (619) 220-6055



Fig. No.

FIG. 1

Appendix C

- ROM Cost Estimate



**Ocean Beach Pier: Design, Furnish, and Install Emergency Shoring at Two Damaged/Missing Pile Locations
San Diego, California**

ROM Budget to Design and Install a Temporary Deck Shoring System at Bents 39 and 45

Date: April 23, 2024

Description	Quantity	Units	\$/Unit	Total	Comments	Working Days
Base Scope						
1 Mobilize/Demobilize	1	LS	\$ 40,347	\$ 40,347	Mobilize equipment, material, tool container, and labor to jobsite prior to start of work. Complete all pre-planning and submittals. Upon project completion, clean work area and demobilize all equipment, debris, and labor from jobsite.	4
2 Construction Engineering: Shoring Design Drawings & Calculations	1	LS	\$ 43,783	\$ 43,783	Liftech Consultants to provide design, calculations, and shoring drawings to support the Ocean Beach Pier in two locations - each where a pile has failed. Design submittal will include drawings and calculations. PECC to coordinate with Moffatt & Nichol and City of San Diego.	-
3 Safety Allowance - Secure Work Areas	2	LOCATIONS	\$ 17,732	\$ 35,464	Develop a site safety plan for submission and review. Install temporary life rings and temporary Jacob's Ladder(s) at four location. Install Safety Wire for tie-off at both Bent 39 and Bent 45 (assume 75LF of safety line at each location. Remove all safety gear upon completion of shoring installation.	2
4 Fabricate/Deliver/Assemble Strong-Back Shoring Beam System for Bent 39 & 45	2	BENTS	\$ 170,186	\$ 340,372	Fabricate Strong-Back Shoring System(s) per Liftech concept sketches. Assume red primer shop coated carbon steel is adequate for three year life expectancy. Deliver steel to Ocean Beach Pier, move steel down to Bent 38 and pre-assemble frames.	8
5 Shore Bent 39 & 45 Precast Deck Sections	4	PANEL SECTIONS	\$ 15,744	\$ 62,976	Install Strong-Back Shoring Systems in final position and pre-tension Toggle Bar Lengths using hydraulic jacks. Lock off toggle bars with nuts and remove hydraulic jacking system. Safe off jacking bars with rebar caps and orange marking paint. No ramps or other cover on the strong-back beams is included.	6
Total Base Scope:				\$ 522,942		20

Project Assumptions

- 1 A working day is defined as an 8-hour weekday between the hours of 6 AM - 5 PM.
- 2 The working days do not include fabrication times for materials (see schedule note below).
- 3 Only one mobilization is assumed, with continuous work until project completion.
- 4 L&H Insurance is included in pricing.
- 5 No contingency is included in this budget.

Schedule Milestones

- 1 On Site Work is expected to take 15 working days.
- 2 Steel Fabrication, including shop drawings (but not shop drawing review) is expected to take 5-6 weeks.

Design Assumption

- 1 City of San Diego or others to procure all project permits.
- 2 City of San Diego or others to confirm the existing deck and pile caps/piles are adequate for the strongback loads.

Subcontractors

- 1 Liftech Consultants, Inc. (Shoring Engineer)

Proposal Exclusions

- 1 Payment and Performance Bonds (available at 1.5% of final contract amount)
- 2 Builders Risk Insurance (can be provided on a per-project basis)
- 3 Permits and Permit Fees
- 4 Engineering or Design unless Mentioned Above
- 5 Utility Relocation unless Listed Above
- 6 Site Survey, Lines, Grade
- 7 Hazardous Materials Handling/Abatement/Removal
- 8 Special Inspection or Testing Fees
- 9 Vibration or Damage Monitoring
- 10 Any Repairs to the Existing Structures, Interior or Exterior, either prior to, during, or after Construction
- 11 Temporary Power & Lighting Install and Supply
- 12 Industrial Hygienist or Inspection Services
- 13 Silt Curtain, Bubble Curtain, or other regulatory requirements not normally encountered.