



OCEAN BEACH FISHING PIER

Draft Evaluation Report

December 4, 2018

Prepared By:



moffatt & nichol

Contents

EXECUTIVE SUMMARY	3
INTRODUCTION.....	4
OBJECTIVES.....	4
SCOPE OF THIS STUDY	4
PIER DESCRIPTION.....	6
PIER HISTORY	8
INVESTIGATIONS PERFORMED	10
UNDERWATER INVESTIGATION.....	10
UNDER-DECK INVESTIGATION.....	10
ABOVE-DECK INVESTIGATION	12
CONCRETE CORING PROGRAM.....	12
INSPECTION FINDINGS.....	14
CONDITION OF PILES AND GRADE BEAMS.....	14
CONDITION OF PILE CAPS.....	15
CONDITION OF DECK SLAB.....	17
ENVIRONMENTAL CONSIDERATIONS.....	20
PIER REPAIR ALTERNATIVE.....	21
PIER REHABILITATION ALTERNATIVE.....	25
PIER REPLACEMENT ALTERNATIVE.....	28
STRUCTURAL ANALYSIS.....	32
WAVE LOAD DEMANDS.....	32
DEGRADED PANEL CAPACITY	32
JACKETED PILE CAPACITY.....	33
SERVICE LIFE ANALYSIS.....	35
BACKGROUND.....	35
PIER SERVICE LIFE.....	36
COURSES OF ACTION.....	38
REPAIR PIER.....	38
REHABILITATE PIER.....	40
REPLACE PIER.....	41
ROUGH ORDER OF MAGNITUDE COST ESTIMATES	44
REPAIR OPTION.....	44
REHABILITATION OPTION.....	45
REPLACEMENT OPTION.....	45
SUMMARY.....	46

EXECUTIVE SUMMARY

The Ocean Beach Fishing Pier, built in 1966, has reached the end of its service life. The pier was inspected above and below water and concrete cores were taken for analysis. Corrosion in the reinforcing steel has initiated and the structure will continue to degrade unless corrective action is taken.

During the inspection, areas of significant deterioration of the primary structural elements was observed. Seven piles were found to have spalling, while 25% of the piles were cracked. There is also significant corrosion in the majority of the pile caps and the soffit of the deck panels.

The capacity of the damaged areas is explored. To ensure the continued use of the structure, these deficiencies must be addressed. Of primary concern is the damaged piles and locations where the deck panels are losing the prestressing strands in the soffit.

Three options for remediation are examined: repair of the structure, rehabilitation, and replacement. There are economic, environmental, and historical issues associated with each option. While the initial cost of the repair option is less, the repairs will not address the continuing deterioration of the pier and the cost to keep the pier operational going forward will be significant.

Rehabilitation will increase the service life of the structure, but the cost is comparable to the replacement option and will change the aesthetics of the structure with the addition of large pile jackets. It will also result in extending the service life, but for a shorter amount of time than possible with the replacement.

Replacement of the structure will allow the City to design the pier for current seismic codes and address sea level rise to ensure the pier will be available for generations to come.



INTRODUCTION

OBJECTIVES

This information is intended to assist the City in making decisions regarding a future project to repair, rehabilitate, or replace the pier. This report serves as the initial phase of project development for this facility. The City will determine the chosen course of action and M&N will provide additional services based on the course of action selected.

SCOPE OF THIS STUDY

Prior to this evaluation report, M&N was contracted to provide two field investigations. The first was a two-day visual inspection of the unsubmerged portion of the pier that took place in July of 2016. This inspection identified major damage and documented the typical conditions of the pier. In the Spring of 2017, a structural condition assessment was performed. This inspection was comprised of an above and below water inspection with a program of concrete coring to determine the chloride levels in the concrete.

FIELD INVESTIGATION

- Perform project research as needed, including the review of existing documents and records.
- Provide field inspection of the top deck surface of the superstructure to determine and record conditions affecting structural capacity.
- Perform an investigation of the underside of the superstructure.
- Provide photographs of observed conditions.
- Provide ASCE “Level I” underwater inspection of all piles and of all grade beams that are visible for inspection without excavation of the bottom soils. “Level I” consists of a swim-by visual inspection of all surfaces of the piles by an engineer diver.



- Provide ASCE “Level II” underwater investigation of 10% of the total piles in the water. “Level II” inspections consist of cleaning the marine growth off the piles in bands at three locations in the height of the water, followed by detailed visual inspection by the engineer diver.
- Finalize the field data for use in analysis and reporting.
- Provide photographs of observed conditions.

DRAFT



BACKGROUND

PIER DESCRIPTION

The Ocean Beach Fishing Pier is located in San Diego at the western terminus of Niagara Street. The main portion of the pier is approximately 2022 ft long and extends in a northwesterly direction from the shore. Two legs extend in a northerly and southerly direction forming a Tee at the outboard end of the pier. The north leg is approximately 193 ft long and the south leg is approximately 368 ft long. The majority of the pier deck is 20 ft wide. At approximately 450 ft from the offshore end of the pier there is a 120 ft long section of the pier that is 40 ft wide. This widened portion of the pier supports a building housing a restaurant, restrooms, and a small store.

The pier structure consists of prestressed and conventionally reinforced concrete components. The piles are precast-prestressed concrete elements that are grouted into holes drilled into the sedimentary rock at the site. The piles supporting Bents 2 through 46, comprising the inshore 1450 feet of the pier, are 16-in. octagonal piles. The remaining bents are supported by 20 in. octagonal piles. Approximately half of the pile cap was cast on the top of the pile prior to installation of the piles. A two-foot long section of the cap at the mid-span was cast in place after the piles were grouted into their sockets (see **Figure 1** and **Figure 2**). After the cast-in-place portion of the cap had attained sufficient strength, precast deck panels were installed on the caps. Lightweight concrete was used in the construction of the precast deck panels to aid in the construction process. A cast-in-place topping was placed over the panels to form the top surface of the deck and to tie the pile caps and deck panels together.





Figure 1 - North leg of the pier under construction



Figure 2 - Two-pile bent prior to placing the cast-in-place joint

The pier has an expansion joint at the abutment and at four locations along the length of the main portion of the pier. The maximum spacing between joints is 480 ft. The inboard end of the outboard span at each

expansion joint is supported by 15 rubber bearing pads. The pier deck slopes downward from the abutment to a low point of 17 feet above mean lower low water (MLLW) at about 750 ft from the abutment. From there the deck slopes up to an elevation of 29 feet above MLLW at the offshore end of the pier.

PIER HISTORY

The Ocean Beach Fishing Pier was designed in 1964 by Ferver-Dorland and Associates and Lykos & Goldhammer Architects and Engineers in joint venture. Construction of the pier was started in May of 1965 and completed in July of 1966 by Teyssier and Teyssier under contract to the City of San Diego.

In 1987 Ferver Engineering Company conducted an investigation of the pier and prepared a report detailing damages found. The report also contained preliminary repair recommendations and construction cost estimates. Contract documents for repairs to the pier were prepared by Ferver Engineering Company in 1989 and construction of the repairs was completed by Marathon Construction in early 1991. The structural repairs entailed removing and replacing concrete and reinforcement damaged by corrosion and adding concrete beams to reinforce the existing precast slabs where a significant number of prestressing strands had been damaged.

During the 1987 underwater investigation, horizontal cracks were observed in several of the piles. The cracks occurred near the ocean bottom in the piles near the ends of the north and south legs of the Tee at the offshore end of the pier. Grade beams were added connecting the piles at the bottom, reducing the effective height of the piles, see **Figure 3**.





Figure 3 - Grade Beam / Pile interface

During the repair of vertical cracks in the piles at Bents 6 through 13 it was discovered that significant damage had occurred to the pile prestressing strands. A change was made to the contract during construction to add reinforced concrete encasements, shown in **Figure 4**, to the affected piles.



Figure 4 - Concrete Encasements at Bent 12

INVESTIGATIONS PERFORMED

UNDERWATER INVESTIGATION

Cleaning and inspection of piles and grade beams were performed in April of 2017 by a team of Engineer/Divers. A Level I inspection, consisting of a visual assessment, was performed to detect significant damage to all the piles and grade beams. Marine growth on the piles prevented detection of minor damage during the Level I inspection. A Level II inspection was done for approximately 10% of the piles and grade beams. The Level II inspection required cleaning the biofouling from the surface of the piles in bands at the top, middle, and bottom of the water column and performing a close inspection for damage to the element.

The piles at Bents 2 through 12 were inspected in the dry at low tide in January of 2017. The remaining piles were inspected using SCUBA equipment.

UNDER-DECK INVESTIGATION

The under-deck investigation was performed in March of 2017. A snooper, shown in **Figure 3**, was used to access the underside of the pier during the pile cap and deck soffit inspection. Damage to the structure was documented and photographed.



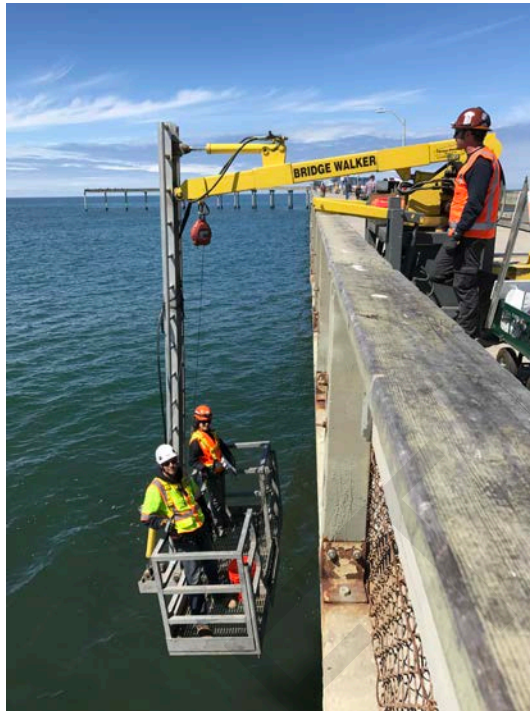

Figure 5 - Snooper used for under deck inspection

DRAFT

ABOVE-DECK INVESTIGATION

A visual inspection was made of the entire deck except for areas at the buildings where the slab surface is not visible. Areas with representative visible damage were chosen and the surface was sounded by tapping with a hammer to identify areas where the concrete surface had delaminated. Areas of delamination along with visible cracks and spalls were recorded.

CONCRETE CORING PROGRAM

To facilitate the execution of the service life analysis, eighteen concrete cores were extracted from the pier for chemical analysis. The coring locations were chosen along the length of the pier and in distinct elements to produce a complete picture of the condition of the concrete over the entire pier.

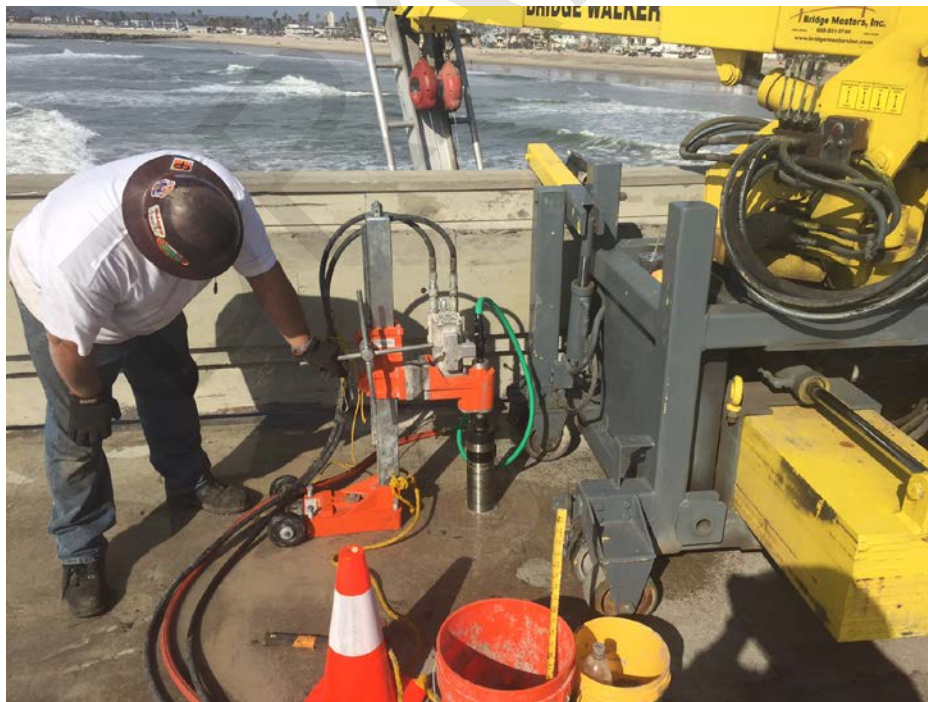

Figure 6 - Coring of the deck

Cores were taken from the piles, pile caps, the deck topping, and prestressed soffit panels, of primary concern is the progress of chloride ions

migrating through the concrete to the reinforcing steel inside. This is discussed further in the Service Life section of the report.



Figure 7 - Example concrete core from Pile Cap 17N

DRAFT

INSPECTION FINDINGS

The plans showing the damage locations is available in Appendix A. The findings are summarized below.

CONDITION OF PILES AND GRADE BEAMS

Vertical cracks were noted on approximately 25% of the piles during the inspection. Most cracks are three to five feet long with the longest noted crack being approximately ten feet long. There are seven piles that have significant spalling and a possible loss of prestress in one or more strands. No damage was observed on the permanently submerged portions of the piles.

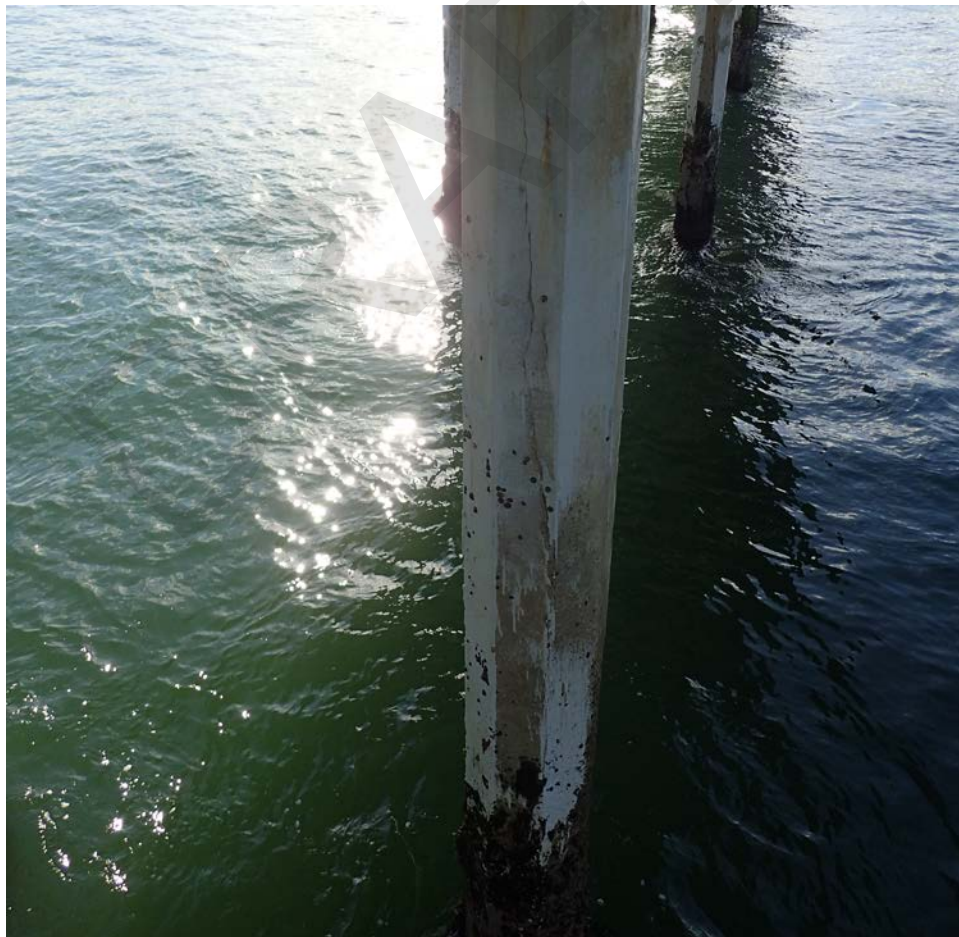

Figure 8 - Crack in Pile 18S (Outboard face)

Some spalling was observed near the tops of the pile jackets. It was found that there is an unreinforced cap that was placed on the top of the jackets to prevent water from ponding and this appears to be the area where the spalling occurs.



Figure 9 - Spalling at jacket (Pile 6N)

CONDITION OF PILE CAPS

The most severe damage observed during this investigation occurred on the pile caps. This damage occurs throughout the length of the pier with virtually every pile cap affected. As in the case of the vertical cracks in the piles, the pile cap damage appears to be due to corrosion of the reinforcement.



Figure 10 - Typical damage on pile cap

Much of the damage appears to be associated with the cast-in-place portion of the cap. It was reported that during the curing of the cast-in-place joint it was very difficult to hold the two precast portions of the cap rigid. Relative movement of the two precast portions during the curing of the joint may well have caused cracking that contributed to the permeability of the joint. This would have allowed more rapid penetration of chloride ions, water, and oxygen to the reinforcement, accelerating the corrosion process.



Figure 11 - Damage in cast-in-place portion of the cap

There is also widespread damage to the sloping portions of the caps.



Figure 12 - Concrete spalling in the pile cap

CONDITION OF DECK SLAB

Damage to the slabs is widespread but not as severe as the damage to the caps. Nearly all the spans contain areas of damage. The precast soffit slabs are prestressed lightweight concrete with specified concrete cover of 1.5 in. over the prestressing strands. The topping is four-inch lightweight

cast-in-place

concrete.



Figure 13 - Typical soffit damage



Figure 14 - Soffit at Bent 32 (Most extreme corrosion)

There is extensive cracking on the edge of the pier deck especially on the south side of the deck in the areas where the deck elevation is low, between Bents 15 and 40. From the rust stains and the location and orientation of the cracks, it appears that these cracks have been caused by corrosion of the reinforcement.



Figure 15 - Typical cracking in deck edge



Figure 16 - Severe spalling of deck edge

ENVIRONMENTAL CONSIDERATIONS

Each of the proposed alternatives have unique sets of environmental impacts or considerations. These considerations can pose significant increases in cost and schedule depending on the alternative considered. These topics, in the context of how they may impact this Project, are introduced below:

- **CEQA/NEPA Compliance** – CEQA environmental compliance is required as the activity will have a direct physical change in the environment. NEPA environmental compliance will be needed if there is a federal nexus (federal action, federal funds or needing federal approval/permitting). Federal approval is likely needed since the pier work is above and/or in Waters of the U.S. The level and complexity of the environmental document needed will depend on the selected Project alternative.
- **Permitting** – The Project will require permits from the California Coastal Commission (CCC), U.S. Army Corps of Engineers (Corps), Regional Water Quality Control Board (RWQCB) and potentially the California State Lands Commission (CSLC). The type of approval required from each of these agencies and the associated approval timelines will vary contingent on the option selected. Other agencies will provide input to these regulatory processes, i.e. the City of San Diego will need to provide a “Local Agency Approval” of the concept plans to the CCC; the U.S. Fish and Wildlife Service and NOAA National Marine Fisheries Service (NMFS) will provide consultation on marine biological resources to the Corps; similarly, the California Department of Fish and Wildlife (CDFW) will provide inputs to the CCC; and the CCC will require a jurisdictional determination from CSLC. It is assumed that the City of San Diego will issue a building and safety permit for the final construction plans.
- **Cultural Resources** – The pier is greater than 50 years old and may be considered a historically significant resource. The Ocean Beach Community Plan states that objects and streetscape features, which includes infrastructure projects like the pier, contribute to the historic and



cultural landscape of the Ocean Beach Community and may be eligible for listing under Criterion F that relates to historic districts (Ocean Beach Community Planning Group and City of San Diego, 2014). Additionally, the OB Pier is located within a Historical District, therefore, any construction will require review by the City of San Diego Historical Resources Board (HRB). As the Project is administered by the City of San Diego for construction, the HRB will be tagged for review. A site-specific historical study may be needed to determine the piers significance. If determined significant, the level of impacts to this resource will vary depending on the alternative selected.

- Sea Level Rise – As part of the Coastal Development Permit approval process, the California Coastal Commission will require that sea level rise (SLR) has been considered in the design. Based on best available science for the region, sea levels are projected to increase by 2.5 to 7 feet by year 2100 (OPC-SAT 2018). The elevation of the pier at its lowest underdeck point (i.e. a pile cap approximately 650 from shore) is 13.5 feet, MLLW. The pier raises quickly from this low point at about 2 feet per bent to a maximum underdeck elevation of 24 feet, MLLW.

Detail on how each of these considerations are anticipated to impact each of the Project alternatives are presented in this section. Once an alternative is selected, more detail on the environmental (including a CEQA checklist) and permitting process will be provided. Note, that the below analysis is based on our current understanding of the Project description, is based on our professional experience on similar Projects in southern California and is tentative to change as regulatory controls evolve over time.

PIER REPAIR ALTERNATIVE

This alternative consists of as-needed repair to structural elements (piles, pile caps, soffit panels, deck) over time as they reach an unacceptable threshold. In-water pile repair would entail the installation of pile jackets that would increase the diameter of the piles by about 8 inches. The pile jackets



will span the whole pile length, from pile cap to mudline, but would not require any dredging. The repair would also change the pile type/aesthetic from octagonal to square on affected piles.

CEQA/NEPA Compliance

It is anticipated that a Categorical Exemption (CE) for minor repair could be filed to comply with CEQA. The CEQA Categorical Exemption, Article 19, Section 15301(d) restoration or rehabilitation of deteriorated or damaged existing structures may be appropriate. Note that the justification of damages to less than a “substantial” definition would be needed for this exemptions use. CE’s are processed quickly (less than a month). It is assumed the City of San Diego will be the lead agency for CEQA.

The NEPA review will be conducted as part of the Corps permitting process.

Permitting

The Corps’ evaluation process for determining if a Project needs a permit is based on whether or not the proposed project is located within or contains a water of the United States, and whether or not the proposed project includes an activity potentially regulated under Section 10 of the River and Harbor Act or Section 404 of the Clean Water Act. Repair work is anticipated to not involve a discharge of dredged or fill material and therefore would likely not fall under Section 404 of the Clean Water Act. However, the Project would involve work and structures in or affecting navigable waters and therefore would be regulated under Section 10 of the Rivers and Harbors Act.

Pier repair would likely fall under a Corps Nationwide Permit (NWP) 3 for Maintenance, which is used for “the repair, rehabilitation, or replacement of any previously authorized, currently serviceable structure or fill, or of any currently serviceable structure or fill authorized by 33 CFR 330.3, provided that the structure or fill is not to be put to uses differing from those uses specified or contemplated for it in the original permit or the most recently authorized modification.” NWP streamline the processing of Corps approval



process. However, as part of this NWP application process, the Corps will conduct a cultural/historical resources review through the State Historic Preservation Office (SHPO). If the Corps/SHPO determines that the pier is a historical resource, it may not be possible to permit the repair project via a NWP.

This NWP 3 is not “pre-certified” by the RWQCB and thus an individual 401 Certification from the San Diego RWQCB is required. The 401 process is initiated via submittal of an application package, including application fee. Following the initial application, the RWQCB typically requests additional information before deeming the application “complete”.

It is assumed that all of the project alternatives are beyond the CDP jurisdiction of the City’s Local Coastal Program and thus the CCC would issue the Coastal Development Permit (CDP) for the repair work. The CCC generally requires a CDP for any “development” activity in the Coastal Zone. “Development” is broadly defined, and does include changes to the size of a structure, and repair or maintenance activities that could result in environmental impacts. Although the coastal resource impacts of pile repair are expected to be minimal, the CCC stresses that “otherwise exempt improvements are more likely to require a permit if located on or adjacent to a wetland, sensitive habitat, bluff, cliff, beach, stream, bay, or ocean,” as this project is (CCC, 2018). CCC staff will require a CDP to assess impacts of and necessary mitigation/avoidance for repair related topics such as water quality, and public access and recreation (pedestrian pier use, surfing, fishing, etc.). Similar to the RWQCB process, the CCC typically requests additional information before deeming the application “complete”. The CDP will ultimately be approved at a CCC hearing.

Coordination with the CSLC will be required to determine if the project is within CSLC’s jurisdiction. As general background, the state of California holds sovereign land ownership of all tidelands and submerged lands and beds of navigable waterways. On tidal waterways, the landward boundary of the State’s sovereign land ownership is the ambulatory ordinary high water



mark, generally measured by the mean high water (MHW) line. Repair work will most likely occur seaward of the MHW line, but would not impact submerged lands, i.e. it is not anticipated that CSLC would claim jurisdiction for this alternative. The Pier Repair alternative is not anticipated to introduce long-term impacts to statewide Public Trust purposes including waterborne commerce, navigation, fisheries, water-related recreation, habitat preservation, and open space. A written jurisdictional determination from CSLC will be required to provide to CCC.

It is anticipated that the permitting process for this alternative will be 8-12 months, with the CCC processing as the critical path on the schedule. It should also be noted that the regulatory agencies issue permits for only limited time periods (e.g. up to five years) and thus permit renewals would be required if as-needed repairs were required beyond the permitted timeframe.

Cultural Resources

In addition to the Corps/SHPO review, the HRB will be required to review the Project as administered by the City of San Diego. Repair work which falls under the description of “in-kind” repair often presents no issues to the HRB. However, the Repair alternative’s change in pile diameter and type (from octagonal to square) may change the aesthetic of the pier. Therefore, HRB review may require coordination such as in-person meetings and the provision of plans and descriptions.

Sea Level Rise

Water level and sea level rise (SLR) projections are presented below in Table 1. Tidal bench mark elevations for La Jolla, CA were sourced from the National Oceanic and Atmospheric Administration (NOAA) data Station 9410230 for the 1983-2001 epoch (NOAA, 2018). Extreme water levels (EWLs) were previously analyzed by M&N in an OB Pier Wave Force Analysis using data from Imperial Beach, CA (M&N, 2004). Sea level rise projections present the best available science as reported in the State of California – Sea-Level Rise Guidance – 2018 Update (OPC-SAT, 2018). Projections represent the 0.5% probability Medium-High Risk Aversion for La



Jolla, CA. Potential future total water levels (TWLs) are summed from EWLs and SLR projections. Note that the TWLs are listed from best case to worst case, i.e. from MLLW water levels with 2030 SLR projections to highest tide with 2150 SLR projections.

Table 1. Current and Future Water Levels at OB Pier

Water Level (NOAA, 2018)		Extreme Water Levels (M&N, 2004)		Sea Level Rise Projections (OPC-SAT, 2018)		Potential Future Water Levels	
Datum	Value (ft, MLLW)	Recurrence Interval (Years)	Water Level (ft, MLLW)	Year	0.5% Probability (ft)	Scenario (SLR Year + EWL)	TWL (ft, MLLW)
MLLW	0.00	5	7.23	2030	+0.9	2030 + 100-yr	8.67
MSL	2.73	10	7.33	2050	+2.0	2050 + 100-yr	9.77
MHHW	5.32	50	7.63	2100	+7.1	2100 + 100-yr	14.87
Highest Observed Tide (11/25/2015)	7.81	100	7.77	2150	+13.3	2150 + 100-yr	21.07

As-needed repair of the pier would not accommodate the potential for sea level rise. Thus, the frequency that the pier would be wetting and drying would increase. The lowest elevation pier cap (elevation ~13.5 ft, MLLW) could experience daily wetting and drying by year 2100. This is anticipated to increase corrosion and decrease the design life of the repairs. Additionally, increased water levels result in larger waves incident on the pier which must be accommodated in the structural design.

PIER REHABILITATION ALTERNATIVE

The pier rehabilitation alternative would consist of repair of about 90 bents, or replacement of the superstructure, installation of pile jackets, and



various deck improvements. All needed work would occur at the same time, as opposed to the repair option where construction is as-needed.

CEQA/NEPA Compliance

It is anticipated that a Mitigated Negative Declaration (MND) would be needed for the Project to satisfy CEQA regulations since construction impacts would more substantial than the Categorical Exemption would cover. It is expected that all impacts from the rehabilitation project could be mitigated to below a level of significance. The MND process will include a public review. It is assumed the City of San Diego would be the lead agency for CEQA.

The NEPA review will be conducted as part of the Corps permitting process.

Permitting

Rehabilitation work will present a greater potential (than repair) for discharge of fill material and therefore would likely require a Corps Section 404 of the Clean Water Act permit. The Project would involve work and structures in or affecting navigable waters and therefore would also be regulated under Section 10 of the Rivers and Harbors Act. The Project would require a Corps Section 404 and 10 permit, which are issued under one authorization. However, due to the amount of repairs, it is likely that a NWP would not be acceptable for this alternative and thus a “Standard Individual Permit” would be required from the Corps. As mentioned for the previous alternative, the Corps will conduct a cultural/historical resources review through the State Historic Preservation Office (SHPO). The Corps will also likely initiate consultation with NOAA National Marine Fisheries Service and U.S. Fish and Wildlife Service regarding potential impacts to marine biological resources.

The Project would require a 401 certification from the RWQCB to address potential impacts to Waters of the U.S. during construction. The 401 process is initiated via submittal of an application package, including application fee. Following the initial application, the RWQCB typically



requests additional information before deeming the application “complete”. Impacted local RWQCB staffing has been increasing the turnaround time for this certification.

A CDP from the CCC would be required. CCC staff will aim to assess, at minimum, impacts of and necessary mitigation/avoidance for rehabilitation related topics such as water quality, and public access and recreation (pedestrian pier use, surfing, fishing, etc.). The CCC typically requests additional information, including the CEQA document, before deeming the application “complete”. The CDP will ultimately be approved at a CCC hearing.

Coordination with the CSLC will be required to determine if the project is within CSLC’s jurisdiction. The Pier Rehabilitation alternative is not anticipated to introduce long-term impacts to statewide Public Trust purposes including waterborne commerce, navigation, fisheries, water-related recreation, habitat preservation, and open space. A written jurisdictional determination from CSLC will be required to provide to CCC. Similar to the Pier Repair alternative, it is likely that the CSLC would not assert jurisdiction for this alternative.

It is anticipated that the permitting process for this alternative will be 12-18 months, with the CCC and RWQCB processing as the critical path. The CE QA MND process would be initiated prior to submittal of permit applications, but could proceed in parallel with permit processing.

Cultural Resources

In addition to the Corps/SHPO review, the HRB will be required to review the Project as administered by the City of San Diego. Repair work which falls under the description of “in-kind” repair often presents no issues to the HRB. However, the Repair alternative’s change in pile diameter and type (from octagonal to square) may change the aesthetic of the pier. Therefore, HRB review may require coordination such as in-person meetings and the provision of plans and descriptions. A site-specific historical study may be needed to determine the significance of impacts to this cultural resource.



Sea Level Rise

Rehabilitation of the pier would not accommodate the potential for sea level rise. Thus, the frequency that the pier would be wetting and drying would increase. The lowest elevation pier cap (elevation ~13.5 ft, MLLW) could experience daily wetting and drying by year 2100. This is anticipated to increase corrosion and decrease the design life of the repairs. Additionally, increased water levels result in larger waves incident on the pier which must be accommodated in the structural design.

PIER REPLACEMENT ALTERNATIVE

Pier replacement consists of demolishing the existing pier and constructing a new pier. The new pier would be designed to current standards and would likely be built from different materials and may have a slightly different alignment, but of a similar overwater footprint area as the existing pier.

CEQA/NEPA Compliance

It is anticipated that a pier replacement would require an Environmental Impact Report (CEQA) / Environmental Assessment (NEPA) since this alternative is likely to result in significant impacts and would be a high-profile public project. Although the NEPA Environmental Assessment (EA) is typically developed as part of the Corps permit process, the EA could be a joint document with the Environmental Impact Report (EIR). Multiple technical studies, including biological resources surveys/assessments and noise analyses, will be required in support of the EIR/EA. It is assumed the City of San Diego would be the lead agency for the EIR, in coordination with the Corps for the EA. The EIR/EA process will include a public review.

Permitting

Pier replacement work will present discharge of fill material and therefore would require a Corps Section 404 of the Clean Water Act permit. The Project would involve work and structures in or affecting navigable waters and therefore would also be regulated under Section 10 of the Rivers and



Harbors Act. The Project will require a Corps Section 404 and 10 permit, which are issued under one authorization. As part of the Corps permit process, the Corps will initiate consultation with the USFWS and NMFS for review of potential marine effects pursuant to the Endangered Species Act, Magnuson-Stevens Fishery Conservation and Management Act (Essential Fish Habitat), Marine Mammal Protection Act, and the Fish and Wildlife Coordination Act. Potential concerns are impacts to marine mammals (e.g. sea lions, sea turtles) and shore birds, from pile-driving activities. Based on review of the EcoAtlas database, eelgrass (Essential Fish Habitat) does not appear to be present near the pier. However, the agencies may require an eelgrass survey to confirm this; if eelgrass is present, the agencies will require compensatory mitigation for any loss of eelgrass from the Project. Additionally, if the overwater footprint or pile number/size of the new pier increases from the existing footprint, the regulatory agencies may require compensatory mitigation for impacts to Waters of the U.S. and tidal habitat. Similar as for the previous alternatives, the Corps will conduct a cultural/historical resources review through the State Historic Preservation Office (SHPO). Given the nature of this alternative (demolition of the existing potentially historic pier), this could be a significant driver to the Corps permit processing schedule.

The Project would require a 401 certification with RWQCB to address potential impacts to Waters of the U.S. during construction and from permanent “fill” from the piles. The 401 process is initiated via submittal of an application package, including application fee. Following the initial application, the RWQCB typically requests additional information before deeming the application “complete”. Impacted local staffing has been increasing the turnaround time for this permit.

A CDP from the CCC would be required. The CCC typically requests additional information, including the CEQA document and 401 certification, before deeming the application “complete”. Given the scope of this alternative, it is likely that multiple information request/response iterations will



be necessary. The CCC will consult with the California Department of Fish and Wildlife regarding potential impacts to marine resources. The CCC will also require clear and compelling rationale for the need for complete pier replacement and additional studies (e.g. wave uprush analysis, coastal sediment transport impacts, surfing), prior to or following CDP issuance. The CDP will ultimately be approved at a CCC hearing.

Coordination with the CSLC will be required to determine if the project is within CSLC's jurisdiction. Depending on final Pier Replacement design, this alternative poses potential long-term impacts to statewide Public Trust purposes including waterborne commerce, navigation, fisheries, water-related recreation, habitat preservation, and open space. For this alternative, it is possible that the CSLC will assert jurisdiction and thus require a lease of State Lands.

Due to the EIR/EA timeline, potential impacts to Waters of the U.S. and marine biological resources, potential historical nature of the pier, and limited local RWQCB staff, the permitting and CEQA/NEPA process for this alternative is estimated to take 2-3 years (potentially up to 4-5 years). This timeline does not account for any public/stakeholder outreach to develop the new pier concept design.

Cultural Resources

In addition to the Corps/SHPO review, the HRB will be required to review the Project as administered by the City of San Diego. The Pier Replacement alternative has the highest potential significant impacts to cultural resources. Therefore, HRB review will likely require significant coordination and community engagement. A site-specific historical study is likely needed to determine the significance of impacts to this cultural resource.

Sea Level Rise

As a part of the CDP process with the CCC, a sea level rise assessment will be required with respect to the Project. The replacement option would allow the pier to be re-designed to accommodate potential sea level rise during the Project's design life. This could allow for decreased wetting and



drying; therefore, a reduction of the amount of corrosion to the pier elements over time. Additionally, increased water levels result in larger waves incident on the pier which must be accommodated in the structural design.

DRAFT



STRUCTURAL ANALYSIS

WAVE LOAD DEMANDS

The maximum wave crest elevation used in the original pier design indicates that the assumed wave crest is below the pier deck soffit for the entire length of the pier by at least three feet. The wave study conducted in 2004 indicates that the maximum wave crest elevation for the 100-year wave is over 5 feet above the soffit of the deck at the controlling location. Observations of the pier during extreme tide and wave conditions support these wave heights.

The pier appears to be performing adequately, but the analysis indicated that the factor of safety for the extreme wave loading is small. The condition of the pier is very important to its continued adequate performance. The guidance on closing the pier to the public during significant wave events is unchanged from the previous recommendation of the bottom of the pile caps.

DEGRADED PANEL CAPACITY

The deck and the piles were evaluated for the original undamaged condition using the 1965 construction drawings and the damaged condition based on field observations. The piles have been evaluated for the original undamaged condition using the 1965 construction drawings and the repair detail based on the 1985 Rehabilitation drawings.

Figure 16 shows the cross section for midspan positive moment in the modelled damaged condition. The positive moment was evaluated for each progressive number of missing/broken strands.



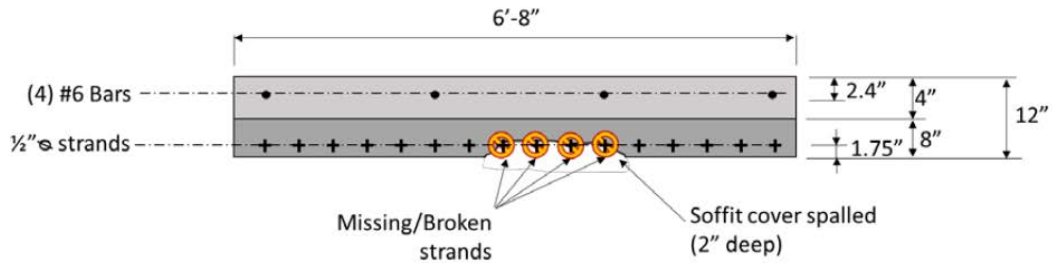

Figure 17 - Midspan Section of Precast Panel

Figure 17 reports the midspan positive moment capacity for a typical panel 6'-8" wide panel in the undamaged state (0 strands lost). The figure also presents the reduced positive moment capacity with each subsequent number of strands lost. Note that when all 16 strands are lost, there is a small amount of theoretical residual strength resulting from the top mat reinforcing, this strength is unreliable as the slab is effectively only 2.4" deep.

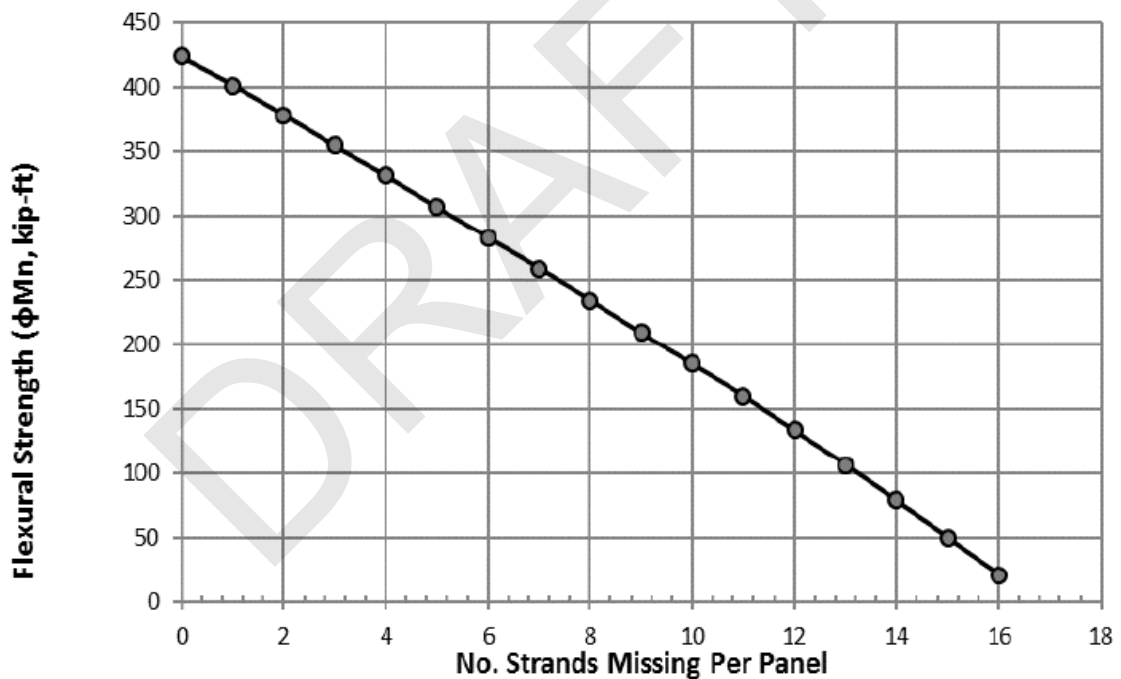

Figure 18 - Positive Moment Strength Corresponding to Number of Strands Lost

JACKETED PILE CAPACITY

Figure 18 shows the results comparing the design P-M interaction curves for the three undamaged pile cross sections (prestressed section, mild steel reinforcement section, and both) and the jacketed pile cross sections for the 16" and 20" piles. This indicates that the repair detail is significantly stronger

than the original undamaged pile sections for all compression axial loads and tension axial loads less than approximately 100kips tension. The shear strength of both piles is also increased significantly.

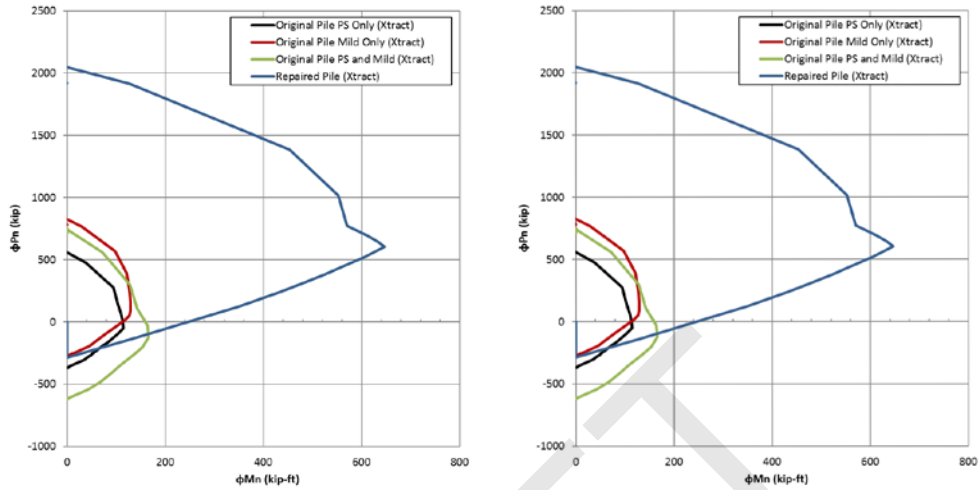

Figure 19 - PM Interaction for 16" (Left) and 20" (Right) Piles

DRAFT

SERVICE LIFE ANALYSIS

BACKGROUND

The concept of “remaining service life as it pertains to existing waterfront infrastructure is often misunderstood. The common definition used in reference to engineering structures is:

“Service life – the length of time during which a structure, or facility, can be used *economically* before emergent damage causes increasing interruptions in facility operations or becomes a threat to public health and safety.”

The damage affecting individual components does not typically degrade so as to cause sudden "catastrophic failure," but the damage can continue to decay until a series of less dramatic occurrences make the limitations of the component obvious. There are several considerations that are important to consider when making a service life evaluation:

Economics

Service life can be prolonged for a facility by virtue of increasingly frequent repairs. At some point, the continued investment in repairs necessary to maintain operations does not "pencil out" from a return-on-investment perspective. This is especially true when the cost for the repairs is linked with the "operational downtime" (loss of revenue) that occurs during the repair process, or the opportunities lost by virtue of not having a modern facility.

Changes in operational use

Inevitably, with the long-term use of a facility, ongoing operations will begin to expose limitations that influence perceived “service life.” Examples of these concepts are as follows:

Operational changes affecting load capacity. This includes the type of vehicle allowed on the pier or the size of wave that causes the pier to be closed to the public.

Changes in design criteria. Engineering and building codes are continually refined. Engineering analysis techniques used by structural



engineers are in a continual state of improvement. Environmental regulations are becoming more stringent and complex. These considerations may affect change in operational use and the way "service life" is perceived.

It is appropriate to consider the following definitions developed by the US Navy, and currently being used regarding marine waterfront facilities repair:

Repair

Maintenance and repair activities necessary to keep a typical inventory of facilities in good working order. Sustainment includes regularly scheduled maintenance as well as cyclical major repairs or replacement of components that occur periodically over the expected service life of the facility. Due to obsolescence, sustainment alone does not keep facilities "like new" indefinitely, nor does it extend their service lives. A lack of full sustainment results in a reduction in service life that is not recoverable in the absence of recapitalization funding.

Rehabilitation

Restoration of real property to such a condition that it can be used for its intended purpose. Includes repair or replacement work to restore facilities damaged by inadequate sustainment, excessive age, natural disaster, fire, accident, or other causes.

The key difference between sustainment and rehabilitation is "service life." If the facility has not exceeded its service life and is being repaired, it is sustainment. If the facility has exceeded its service life and is being repaired, it is rehabilitation.

Replacement

Alteration or replacement of facilities solely to implement new or higher standards (typically regulatory changes), to accommodate new functions, or to replace structure components that typically last 50 years or more.

PIER SERVICE LIFE

To verify the remaining service life in the structure, a coring and testing program was undertaken to determine the condition of the structure in situ.



The core locations were chosen to represent both the types of elements and a sampling of the different exposure conditions along the pier. Cores were taken from the piles, pile caps and the deck. Three cores were subjected to petrographic examination to determine the cementitious material ratio of the concrete in the elements. This information was used to facilitate the service life modeling.

All but one of the cores were tested for chloride concentration profiles and specifically for chloride content at the depth of reinforcement. The final core (Pile 7N) was subjected to a full depth profile. The majority of the tests showed that the chloride concentrations in the soffit panel, pile caps and piles exceed the threshold for corrosion initiation. The reinforcement in the concrete topping at the deck has not. The results of the modelling and visual observation of steel found in the cores also supports these conclusions.

The full report, *Evaluation of Remaining Service Life of Reinforced Concrete Elements of Ocean Beach Pier, San Diego, California* is available in Appendix B.

By the definition of service life above, the pier has exceeded its service life. This is not unexpected, as the structure has been subjected to the marine environment for over 52 years. The corrosion of the reinforcement in the soffits, pile caps and piles has begun, and the structure will continue to degrade. This will make a repair program economically challenging.



COURSES OF ACTION

REPAIR PIER

There is significant deterioration over large sections of the pier. As discussed above, there is widespread spalling on the pile caps and the deck soffit. Several piles also exhibit spalling that would need to be addressed. Since there is very little redundancy in the structure, the failure of a single pile could be substantial. The repair of the structure would not significantly increase the service life of the structure, as the chloride levels in the concrete indicate that additional deterioration is imminent. If the repair option is chosen a significant amount of resources will be required going forward to continuously repair the structure.

The piles that are currently spalling would need a structural jacket to both contain the expansive force of the corroding steel and to act as the new structural member. This square jacket would be conventionally reinforced and would increase the pile diameter by approximately 12-inches. This jacketing program would need to continue, as the currently cracked piles will continue to degrade and will need repair soon. Eventually, it is likely that every pile on the pier will need to be jacketed.

The pile cap repair detail will consist of removing the corroded rebar and the spalled concrete, along with additional concrete behind the rebar locations. This will allow for competent concrete to be placed with the rebar. Additional anodes should be installed at this time to mitigate the corrosion cells that form when concretes of different ages are cast adjacently. This corrosion occurs due to a difference in pH levels in the new and existing concrete.



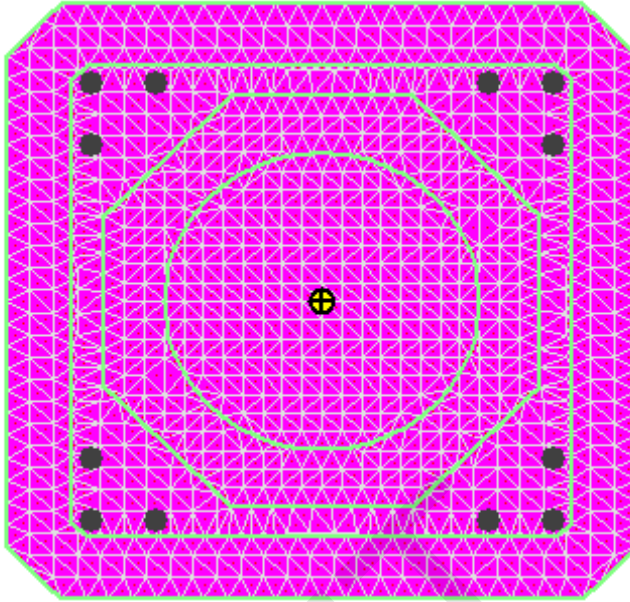

Figure 20 - Pile Jacket

For prestressed members, splicing to the existing reinforcement is generally not practical, so alternative methods are used to replace the capacity lost due to deterioration of the prestressing strands. A cast-in-place beam would need to be installed under the existing section. This is necessary because the loss of the prestress in the strands is not repairable. This type of repair can be seen in **Figure 20**. This repair is executed by cutting a trench in the existing deck, placing formwork below and installing the rebar cage before pouring.



Figure 21 - Cast-in-place Beam Repair

The edge of the deck and the railing supports would be repaired similar to the pile cap repairs with the spalled concrete and compromised rebar being removed and a new edge cast.

Repair recommendations do not address strengthening the existing structure beyond its original capacity. Conceptual repairs were developed to prepare a rough-order of magnitude cost estimate to repair the pier. Most repairs consist of removal and replacement of damaged concrete and reinforcement. The actual method of repair must be left to the discretion of the Engineer of Record designing the repairs.

REHABILITATE PIER

In this option, the pier would be substantially renovated, with every pile being jacketed, and the super structure either replaced or the deck (CIP beam) and pile cap repair discussed above being done at every bent. A new deck topping would be incorporated with the edge repair, with additional rebar in the topping. The superstructure could also be replaced entirely. This would

be similar to the replace option with new pile caps over the pile jackets and the new panels and topping.

REPLACE PIER

The pier would be replaced in its entirety. The existing superstructure would be demolished. It may be feasible to use the existing pier as the formwork to build the new structure. These options would be explored further if the replacement option is selected by the City. Based on guidance received from the City, the pier would be replaced with a structure that looks similar to the current pier. It would be up to the City to determine if the historical aesthetics of the original pier be preserved, or if an original design would be considered.

New 24-inch octagonal precast-prestressed (PC/PS) concrete piles would be required, similar to the existing piles at the outboard end (20 in. octagonal) but larger to account for increased seismic mass of a thicker deck and to reduce the chance of cracking observed in the piles near the end of the south leg of the T. A single pile size was used for the full length of the pier to keep the pile size uniform. Pile tip elevations are based on providing a 14 ft embedment below sandstone. It is assumed that the piles will be drilled and grouted into sockets.

Pile bents are located outboard of the existing bents. This would allow the Contractor to utilize the existing pier as a work platform if there is adequate capacity in the existing pier at the time of construction. The pier alignment is generally the same as the existing pier, with the exception that a portion of the south leg deviates slightly from the existing to allow for easier construction. The typical pile cap is a single element with 2'-8" sockets for the piles. The pile caps would extend through the cap and the pile would be embedded nearly the full height of the cap and grouted in place. To increase the anchorage of the piles at the new pier, dowels are used to help transfer the load. An embedded steel wide flange beam is used to support the pile cap



while the lower 18 inches is grouted in place. The dowels and embedded portion of the pile provide the moment and axial load connection from pile to cap.

Deck spans are typically 30 feet for the new pier. This matches the existing OB pier and is similar to the other piers built using PC/PS deck panels and topping. Typical deck construction for the new pier consists of 12-inch thick PC/PS deck panels with 7.5-inch cast-in-place (CIP) topping. This is a slightly thicker deck than the existing pier. A thicker concrete cover over the reinforcement and prestressing steel is provided for increased durability. There may be an opportunity during design to reduce the overall thickness. In order to get 3 inches of cover on the topping reinforcement and have adequate room for the topping reinforcement and for concrete below the reinforcement a 7.5-inch topping thickness is assumed.

The portions of the pier deck over land are assumed to be cast-in-place (CIP) based on local contractor preference and a similar deck thickness requirement and ease of using falsework. Using CIP deck also allows for some flexibility in pile locations. The deck sections are based on the CALTRANS Design Aids for slab bridges. Three 51-foot spans are used in the tidal area to match the existing spans. For these spans, voided PC/PS planks with topping are assumed, similar to the existing construction. The voided plank construction is based on CALTRANS standard details for voided planks.

The elevation of the pier deck has been raised over most of the pier in the new design. The new pier deck follows the existing pier profile for approximately 600 ft near the shore. At the point where the bottom of the pier deck is approximately at the same elevation as the maximum wave crest elevation from the 2004 wave study. The deck elevation follows a straight slope up to the elevation of the existing legs of the pier at the T. This profile follows the profile of the maximum wave crest elevation closely so that the bottom of deck elevation is close to the maximum crest elevation over the



majority of the length of the pier. The maximum difference in elevation between the new and existing pier decks is approximately six feet.

Recent projects have used up to 1000 feet between deck expansion joints. The existing OB pier has joints spaced 400 to 500 ft oc. For the new pier concept, it is assumed that expansion joints are provided near the head of the T, Near the shore where the construction type and span length change and at approximately the midpoint between these two joints. The maximum distance between joints is approximately 840 ft.

DRAFT



ROUGH ORDER OF MAGNITUDE COST ESTIMATES

Construction costs were developed for the three options to assist the City in moving forward with remediation. With the current condition of the pier and the magnitude of wave forces and potential seismic forces that the pier will be exposed to, severe damage or partial collapse of the pier is possible if the deterioration of the structure is allowed to continue.

The decision should consider both the long-term costs of the options and the service life of the resulting structure, as well as environmental and community concerns.

The construction cost estimates are our opinion of construction cost based on our observations. Cost Estimates can be found in Appendix E. Actual costs for labor, material, and equipment vary with time and bidding climate.

Our estimate of costs does not include the following:

1. Preparation of final design, plans, specifications and estimates
2. Strengthening of the structure for gravity, wave or seismic loading
3. Contract Management
4. Construction inspection and testing
5. Economic loss due to loss of use of the facility during construction
6. Environmental permitting efforts and permit fees
7. Building Department Plan Check, Permit, and Inspection fees
8. Escalation to the time of construction.

REPAIR OPTION

The rough order of magnitude (ROM) cost for repairing the existing damage to the pier and placing galvanic anodes to mitigate additional corrosion is estimated be \$8,000,000. This repair program could be tailored to address the most egregious locations first and then continue an inspection /



repair cycle going forward if the funding needed to be distributed. There are also additional costs for mobilizing a marine contractor for multiple repair cycles.

If the repair option is chosen, the structure will continue to degrade, and the repair cost will escalate with time. There will be additional costs for the continued inspections every three years, repair design, and subsequent repairs. For example, the seven piles that need to be jacketed currently were cracked a decade ago. This implies that there will be dozens of piles requiring jackets in the next ten years. This represents significant capital investment and additional closures of the facility for repair activities. Additionally, the pier will continue to need to be closed in large storm events and is at greater risk in a seismic event. Over the 50-year life this would be the least cost effective option.

REHABILITATION OPTION

The rehabilitation option would increase the service life of the structure but would not address the sea level rise vulnerability. The ROM for the rehabilitation option is \$30,000,000 to \$50,000,000. If environmental constraints make the replacement option unfeasible, rehabilitation is the most cost-effective solution.

REPLACEMENT OPTION

The replacement option could be designed for a 50 to 75-year service life. Replacement would also allow for the accommodation of sea level rise, design for improved seismic performance, and provide a reduction in the time the pier will be closed due to large wave events. While this path forward includes the largest initial capital expenditure, it will likely be the most cost effective over the next 50 years. The ROM for the replacement option is \$40,000,000 to \$60,000,000.



SUMMARY

Significant investment in a repair program would need to be well funded and sustained, as the structure will continue to exhibit significant deterioration in the near term. The rehabilitation option and replace option, while both are large endeavors requiring capital investments and pier closures, would be a better long-term solution to keeping the pier operational. The replacement of the pier would be the recommended choice, as the structure could be designed efficiently to resist seismic events and the threat of sea level rise can be addressed.

DRAFT



APPENDIX A– Conceptual Drawings

- Repair Option
- Rehabilitation Option
- Replacement Option

DRAFT

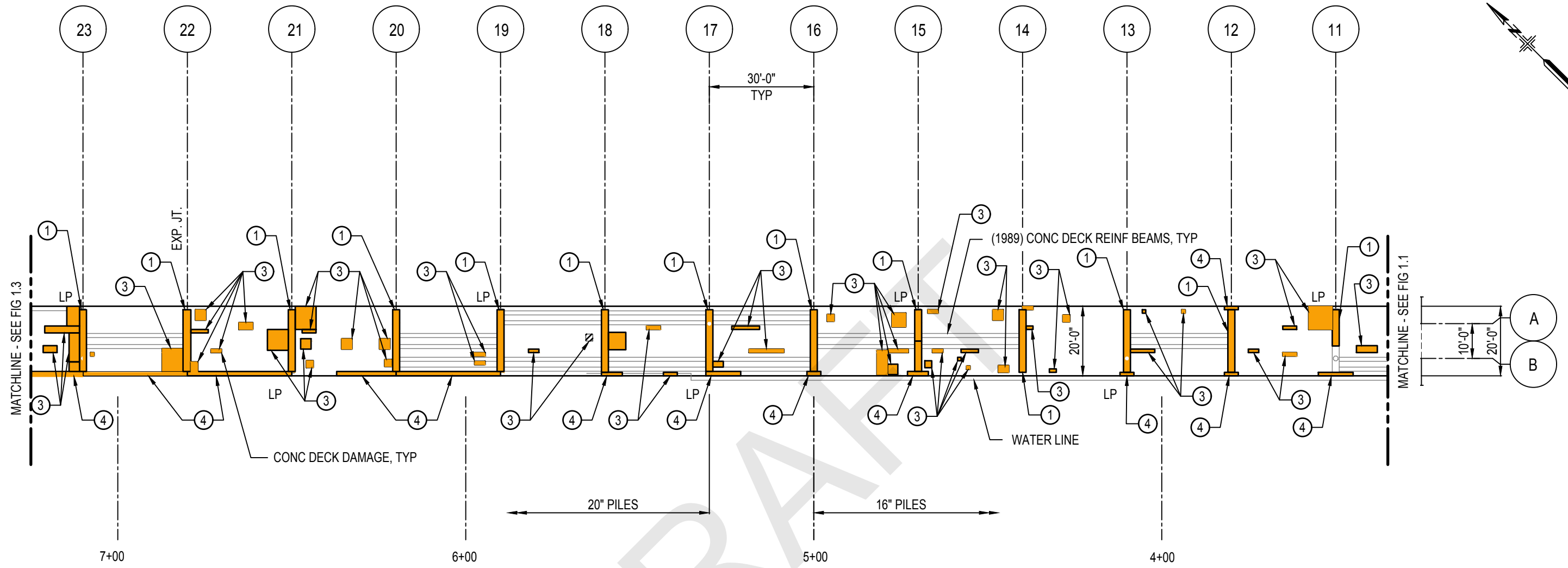

DAMAGE TYPE	REPAIR DETAILS	SAMPLE PHOTOS FIG 1.12
① PILE CAP DAMAGE	FIG 1.11	PHOTO #: 1 AND 2
② PILE DAMAGE	FIG 1.8	PHOTO #: 3 AND 4
③ UNDERDECK DAMAGE	FIG 1.10	PHOTO #: 5 AND 6
④ LONGITUDINAL BEAM DAMAGE	FIG 1.9	PHOTO #: 7 AND 8
⑤ CONC STAIR DAMAGE	FIG 1.10 SIM	PHOTO #: 9 AND 10

LEGEND:
 LP INDICATES LIGHT POLE

PARTIAL SOFFIT DECK PLAN - 2
 SCALE: 1"=30'-0"

REPAIR OPTION

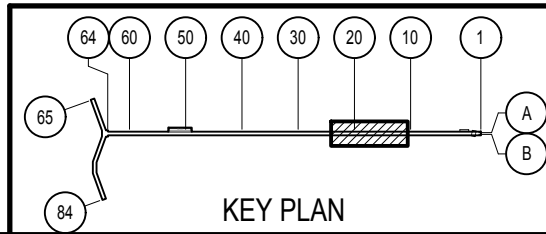

**REPORT FOR MODIFICATIONS TO THE OCEAN BEACH PIER
 SAN DIEGO, CALIFORNIA**

1660 HOTEL CIRCLE NORTH, SUITE 500
 SAN DIEGO, CALIFORNIA 92108
 PHONE: (619) 220-6050
 FAX: (619) 220-6055

THE CITY OF SAN DIEGO

Fig. No.

FIG 1.2

FILE NAME: 031510487 - ob_pier2.dwg LAYOUT NAME: PARTIAL SOFFIT DECK PLAN - 2 PLOTTED: Friday, November 30, 2018 2:45pm USER: dvlions

FILE NAME: 0315010487 - ob_pier.dwg DESIGN INFORMATION: CADD/LOI - Report: 1.3.dwg LAYOUT NAME: PARTIAL SOFFIT DECK PLAN - 3 PLOT DATE: Friday, November 30, 2018 2:45pm USER: dvlions

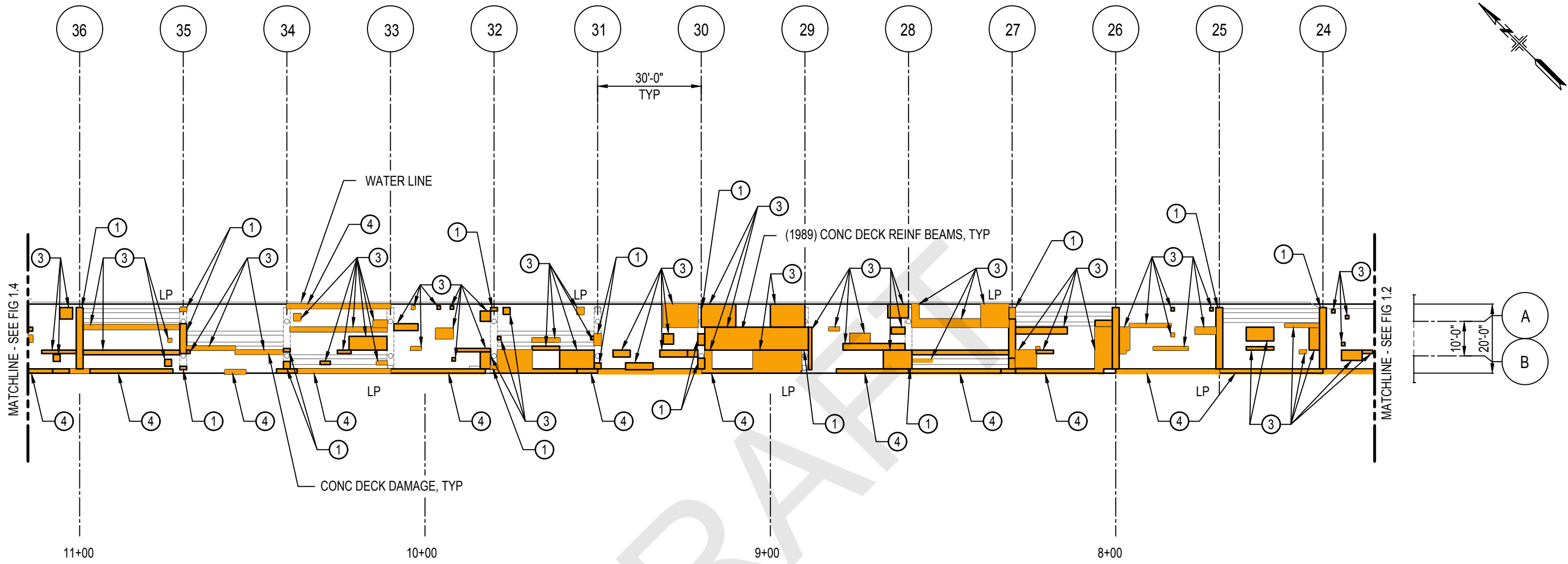

DAMAGE TYPE	REPAIR DETAILS	SAMPLE PHOTOS FIG 1.12
① PILE CAP DAMAGE	FIG 1.11	PHOTO #: 1 AND 2
② PILE DAMAGE	FIG 1.8	PHOTO #: 3 AND 4
③ UNDERDECK DAMAGE	FIG 1.10	PHOTO #: 5 AND 6
④ LONGITUDINAL BEAM DAMAGE	FIG 1.9	PHOTO #: 7 AND 8
⑤ CONC STAIR DAMAGE	FIG 1.10 SIM	PHOTO #: 9 AND 10

LEGEND:
LP INDICATES LIGHT POLE

PARTIAL SOFFIT DECK PLAN - 3
SCALE: 1"=30'-0"

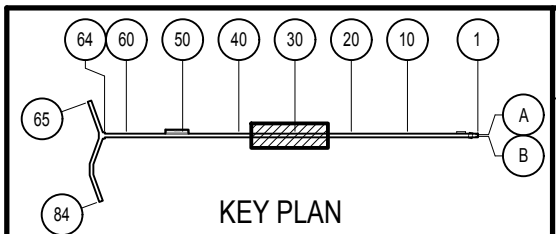

REPAIR OPTION	
REPORT FOR MODIFICATIONS TO THE OCEAN BEACH PIER SAN DIEGO, CALIFORNIA	
	1660 HOTEL CIRCLE NORTH, SUITE 500 SAN DIEGO, CALIFORNIA 92108 PHONE: (619) 220-6050 FAX: (619) 220-6055
	Fig. No. FIG 1.3

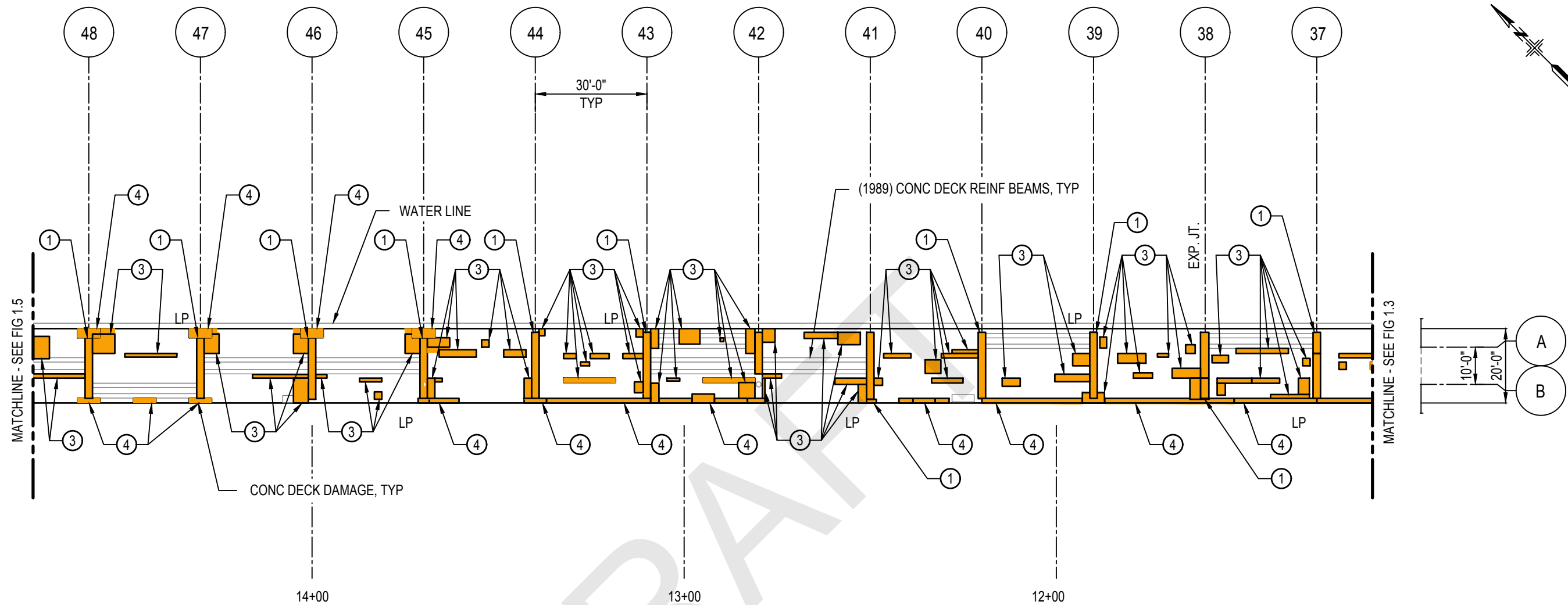

DAMAGE TYPE	REPAIR DETAILS	SAMPLE PHOTOS FIG 1.12
① PILE CAP DAMAGE	FIG 1.11	PHOTO #: 1 AND 2
② PILE DAMAGE	FIG 1.8	PHOTO #: 3 AND 4
③ UNDERDECK DAMAGE	FIG 1.10	PHOTO #: 5 AND 6
④ LONGITUDINAL BEAM DAMAGE	FIG 1.9	PHOTO #: 7 AND 8
⑤ CONC STAIR DAMAGE	FIG 1.10 SIM	PHOTO #: 9 AND 10

LEGEND:
LP INDICATES LIGHT POLE

PARTIAL SOFFIT DECK PLAN - 4
SCALE: 1"=30'-0"

REPAIR OPTION

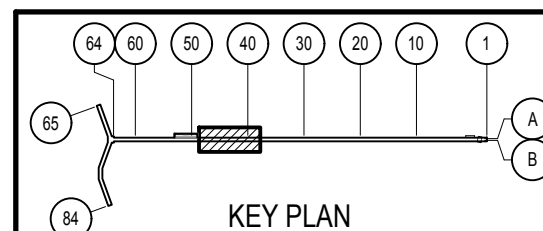

**REPORT FOR MODIFICATIONS TO THE OCEAN BEACH PIER
SAN DIEGO, CALIFORNIA**

1660 HOTEL CIRCLE NORTH, SUITE 500
SAN DIEGO, CALIFORNIA 92108
PHONE: (619) 220-6050
FAX: (619) 220-6055

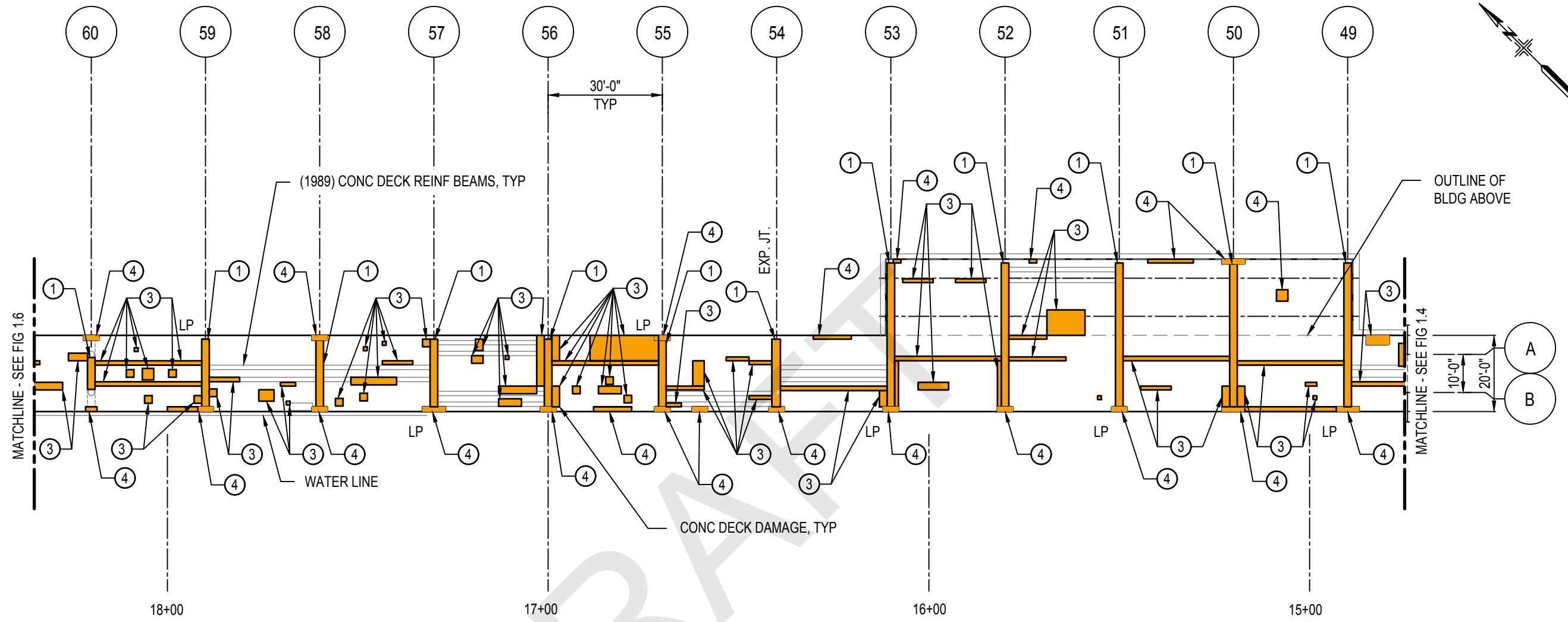



Fig. No. **FIG 1.4**

FILE NAME: 031510487 - ob_pier_v design information\ADD\01 - Report\4.4.dwg LAYOUT NAME: PARTIAL SOFFIT DECK PLAN - 4 PLOT DATE: Friday, November 30, 2018 2:46pm USER: dvlilions



DAMAGE TYPE	REPAIR DETAILS	SAMPLE PHOTOS FIG 1.12
① PILE CAP DAMAGE	FIG 1.11	PHOTO #: 1 AND 2
② PILE DAMAGE	FIG 1.8	PHOTO #: 3 AND 4
③ UNDERDECK DAMAGE	FIG 1.10	PHOTO #: 5 AND 6
④ LONGITUDINAL BEAM DAMAGE	FIG 1.9	PHOTO #: 7 AND 8
⑤ CONC STAIR DAMAGE	FIG 1.10 SIM	PHOTO #: 9 AND 10

LEGEND:
LP INDICATES LIGHT POLE

PARTIAL SOFFIT DECK PLAN - 5
SCALE: 1"=30'-0"

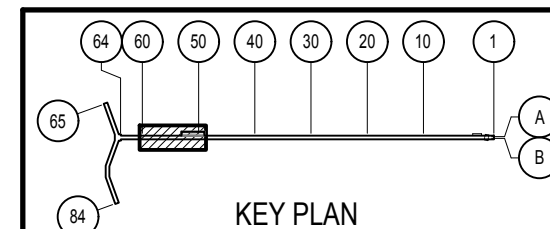

REPAIR OPTION	
REPORT FOR MODIFICATIONS TO THE OCEAN BEACH PIER SAN DIEGO, CALIFORNIA	
	1660 HOTEL CIRCLE NORTH, SUITE 500 SAN DIEGO, CALIFORNIA 92108 PHONE: (619) 220-6050 FAX: (619) 220-6055
	Fig. No. FIG 1.5

FILE NAME: G:\30\4487 - ob_pier\3 design information\ADD\1 - Report\1.5.dwg LAYOUT NAME: PARTIAL SOFFIT DECK PLAN - 5 PLOTTED: Friday, November 30, 2018 - 2:46pm USER: dvlions

FILE NAME: 0315010487 - ob_pier.dwg LAYOUT NAME: PARTIAL SOFFIT DECK PLAN - 6 PLOTTED: Friday, November 30, 2018 - 2:46pm USER: dwilliams

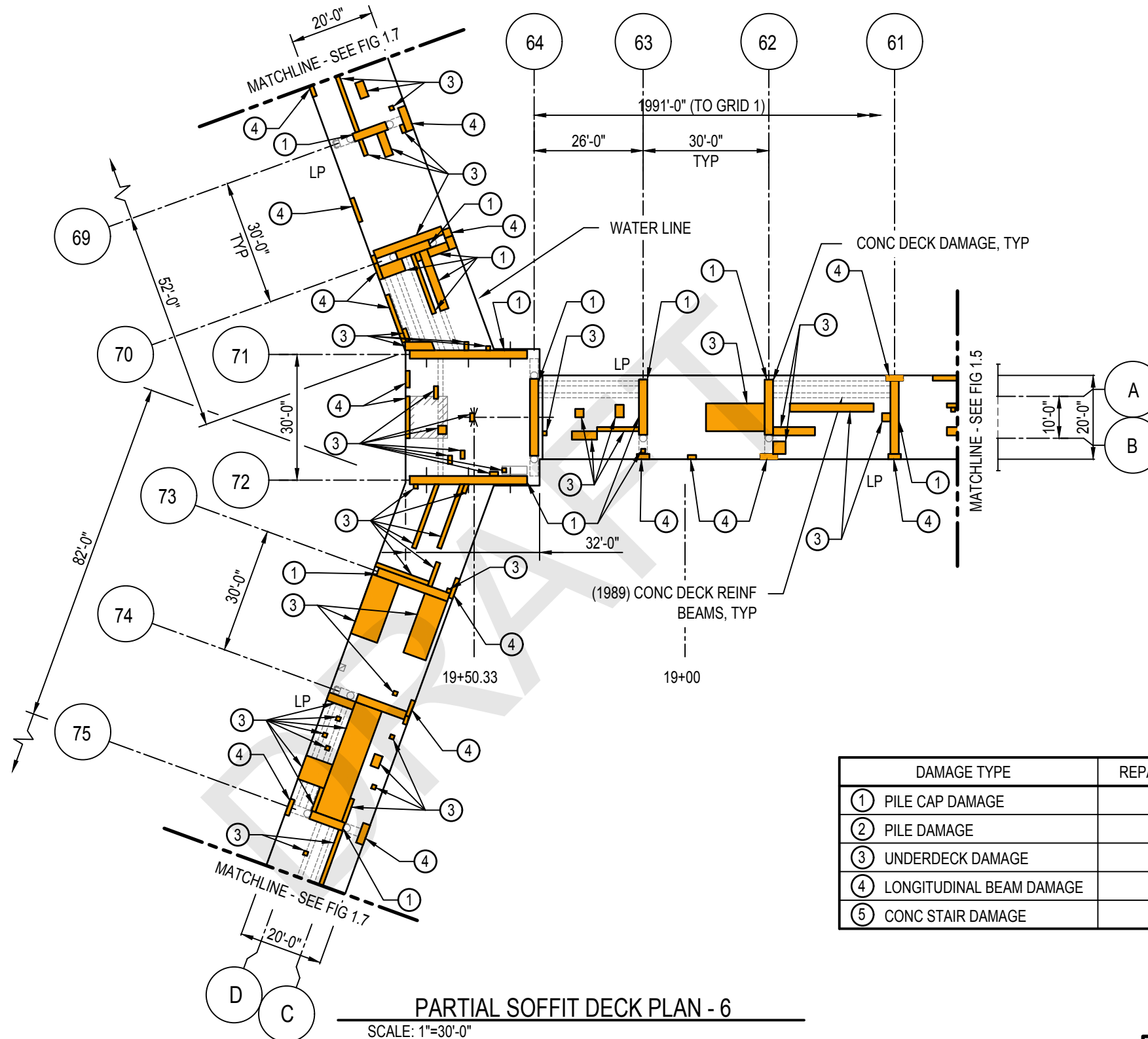

LEGEND:
 LP INDICATES LIGHT POLE

DAMAGE TYPE	REPAIR DETAILS	SAMPLE PHOTOS FIG 1.12
① PILE CAP DAMAGE	FIG 1.11	PHOTO #: 1 AND 2
② PILE DAMAGE	FIG 1.8	PHOTO #: 3 AND 4
③ UNDERDECK DAMAGE	FIG 1.10	PHOTO #: 5 AND 6
④ LONGITUDINAL BEAM DAMAGE	FIG 1.9	PHOTO #: 7 AND 8
⑤ CONC STAIR DAMAGE	FIG 1.10 SIM	PHOTO #: 9 AND 10

PARTIAL SOFFIT DECK PLAN - 6

SCALE: 1"=30'-0"

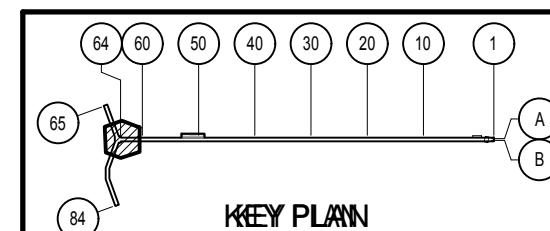

REPAIR OPTION

REPORT FOR MODIFICATIONS TO THE OCEAN BEACH PIER
 SAN DIEGO, CALIFORNIA

1660 HOTEL CIRCLE NORTH, SUITE 500
 SAN DIEGO, CALIFORNIA 92108
 PHONE: (619) 220-6050
 FAX: (619) 220-6055

Fig. No.
FIG 1.6

FILE NAME: 031501487 - ob_pier.v design information\OAD\101 - Report\1.7.dwg LAYOUT NAME: PARTIAL SOFFIT DECK PLAN - 7 PLOTTED: Friday, November 30, 2018 2:46pm USER: dwilliams

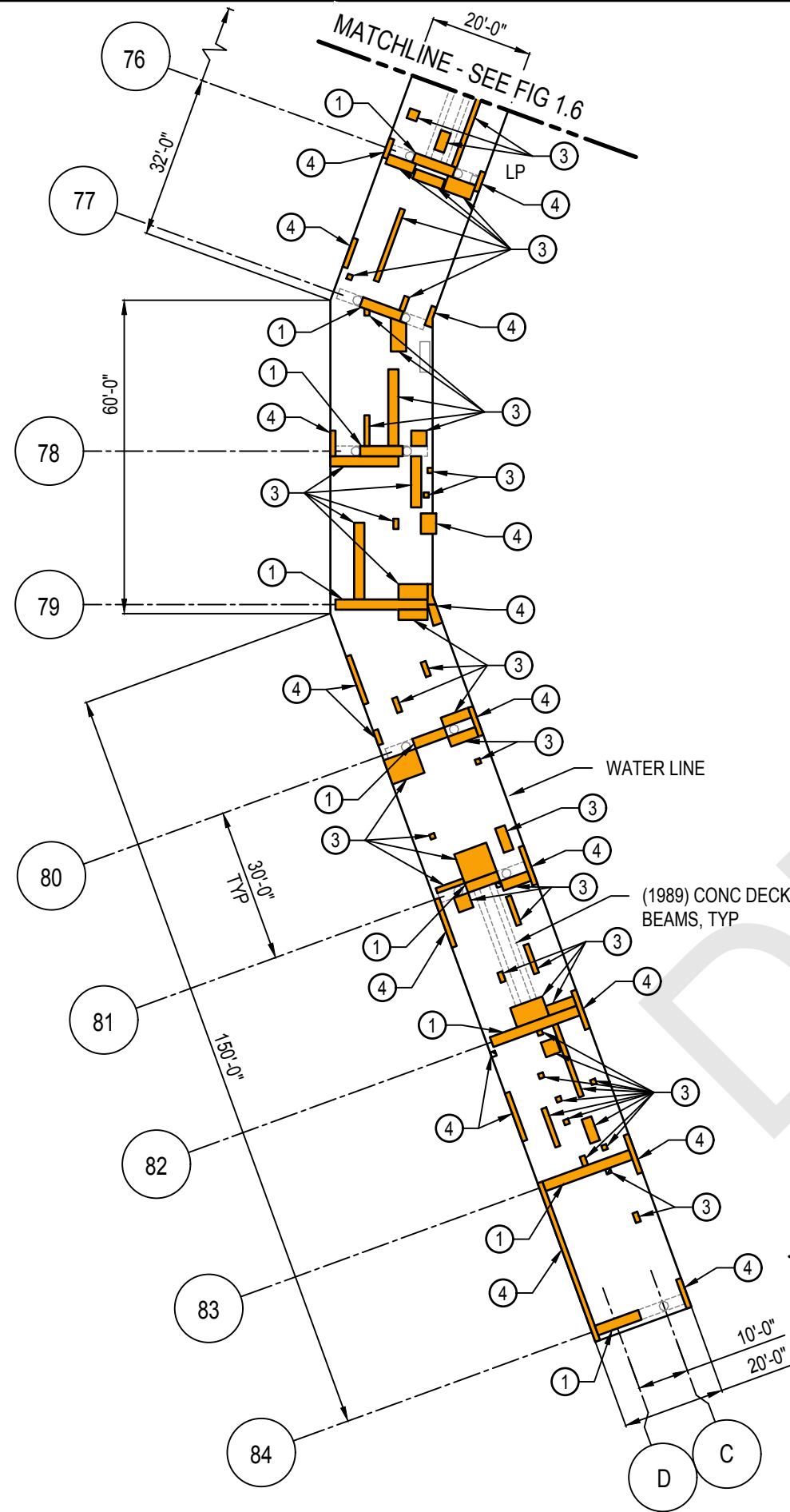

PARTIAL SOFFIT DECK PLAN - 7

SCALE: 1"=30'-0"

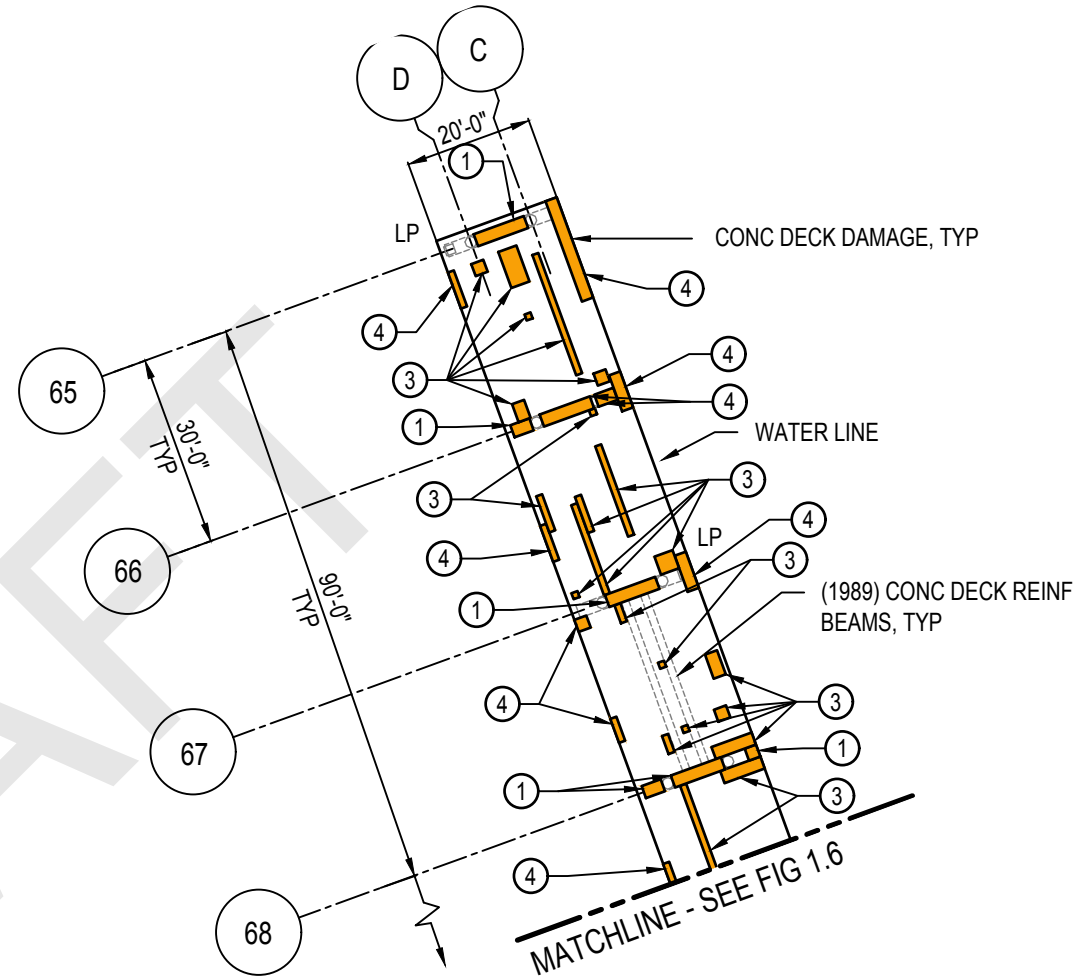

DAMAGE TYPE	REPAIR DETAILS	SAMPLE PHOTOS FIG 1.12
① PILE CAP DAMAGE	FIG 1.11	PHOTO #: 1 AND 2
② PILE DAMAGE	FIG 1.8	PHOTO #: 3 AND 4
③ UNDERDECK DAMAGE	FIG 1.10	PHOTO #: 5 AND 6
④ LONGITUDINAL BEAM DAMAGE	FIG 1.9	PHOTO #: 7 AND 8
⑤ CONCRETE STAIR DAMAGE	FIG 1.10 SIM	PHOTO #: 9 AND 10

LEGEND:
LP INDICATES LIGHT POLE

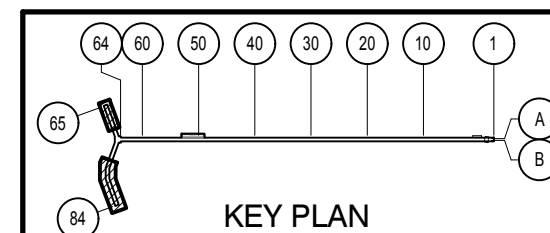

KEY PLAN

REPAIR OPTION

**REPORT FOR MODIFICATIONS TO THE OCEAN BEACH PIER
SAN DIEGO, CALIFORNIA**



1660 HOTEL CIRCLE NORTH, SUITE 500
SAN DIEGO, CALIFORNIA 92108
PHONE: (619) 220-6050
FAX: (619) 220-6055



Fig. No.

FIG 1.7

FILE NAME: 031519487 - ob pier - repair 1.8.dwg LAYOUT NAME: REPAIR DETAILS - 1 PLOTTED: Friday, November 30, 2018 - 2:46pm USER: williams

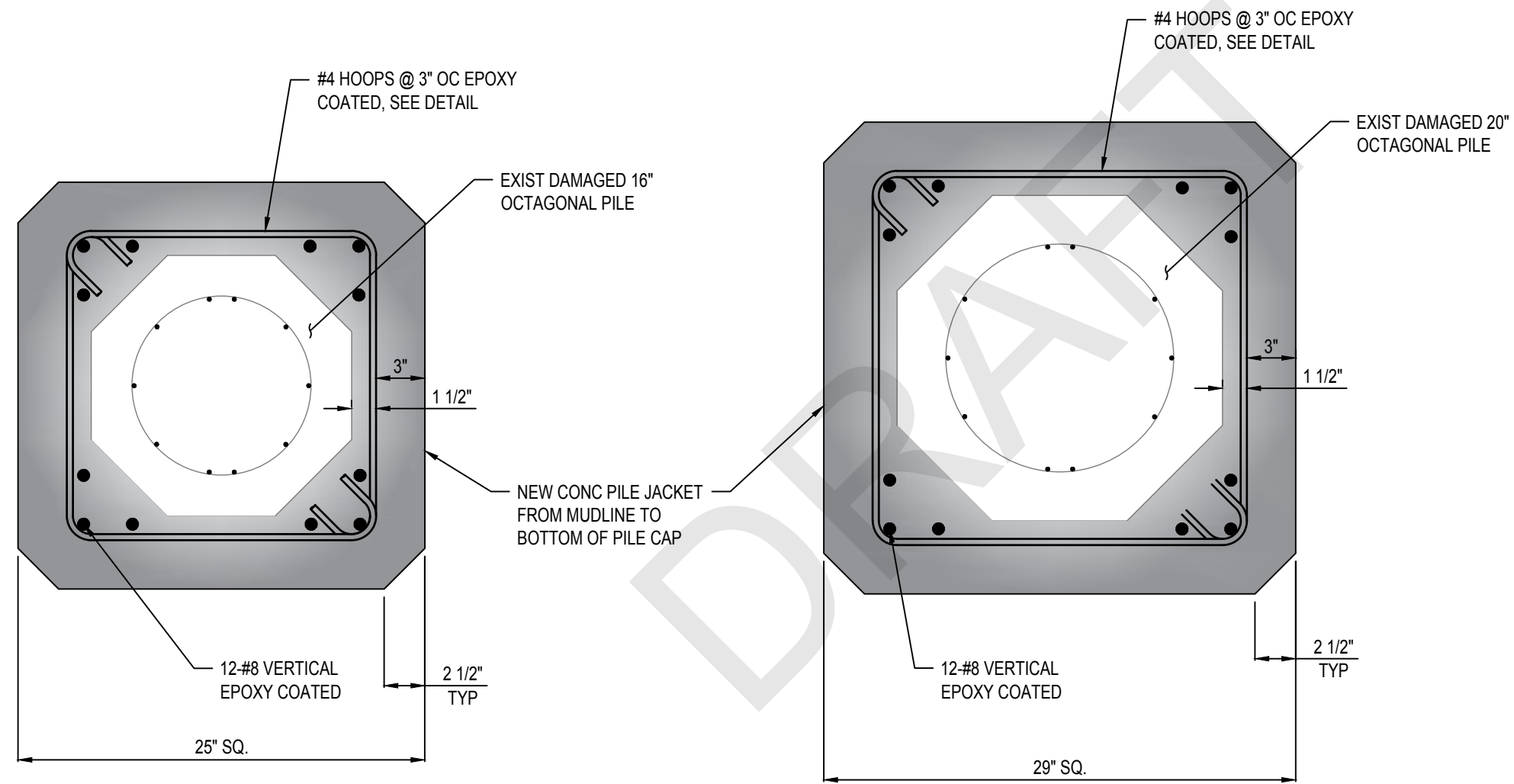

F NEW 16" PILE JACKET
NO SCALE

G NEW 20" PILE JACKET
NO SCALE

REPAIR OPTION

REPORT FOR MODIFICATIONS TO THE OCEAN BEACH PIER
SAN DIEGO, CALIFORNIA



1660 HOTEL CIRCLE NORTH, SUITE 500
SAN DIEGO, CALIFORNIA 92108
PHONE: (619) 220-6050
FAX: (619) 220-6055



Fig. No.

FIG 1.8

FILE NAME: Q:\30\4487 - ob pier\design information\A00\A1 - Repair\4487 OB Pier - repair 1.9.dwg LAYOUT NAME: REPAIR DETAILS - 2 PLOTTED: Friday, November 30, 2018 - 2:46pm USER: williams

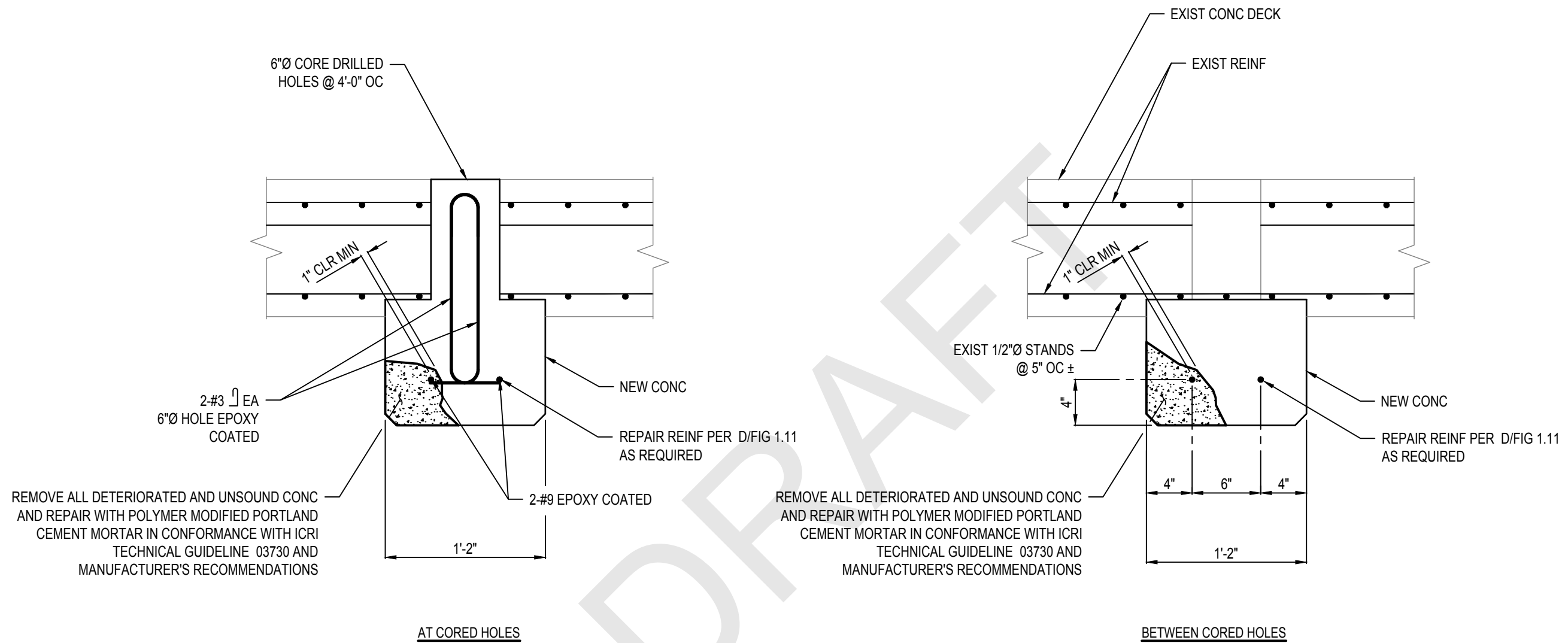

A1 HORIZONTAL CONCRETE BEAMS BETWEEN PILE CAPS
NO SCALE

REPAIR OPTION

REPORT FOR MODIFICATIONS TO THE OCEAN BEACH PIER
SAN DIEGO, CALIFORNIA



1660 HOTEL CIRCLE NORTH, SUITE 500
SAN DIEGO, CALIFORNIA 92108
PHONE: (619) 220-6050
FAX: (619) 220-6055



Fig. No.

FIG 1.9

FILE NAME: Q:\30\487 - ob pier\design information\0401\01 - Repair\487 OB Pier - repair 110.dwg LAYOUT NAME: REPAIR DETAILS - 3 PLOTTED: Friday, November 30, 2018 2:46pm USER: enllions

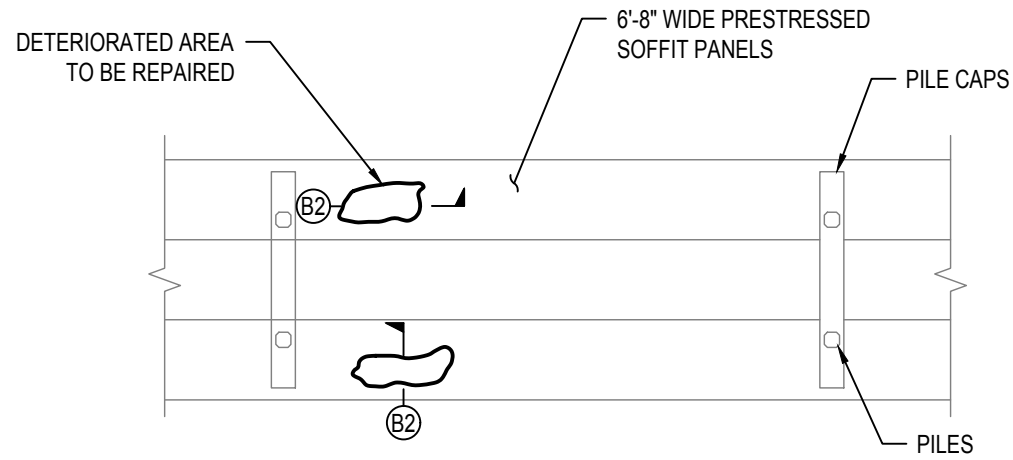

B1 PLAN OF DECK SOFFIT
NO SCALE

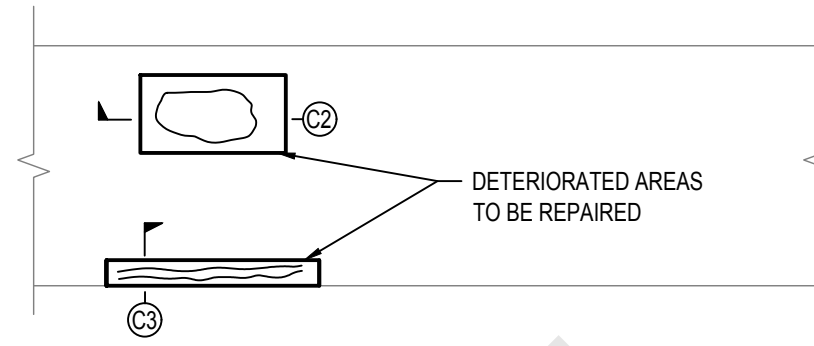

C1 PLAN AT TOP OF SLAB
NO SCALE

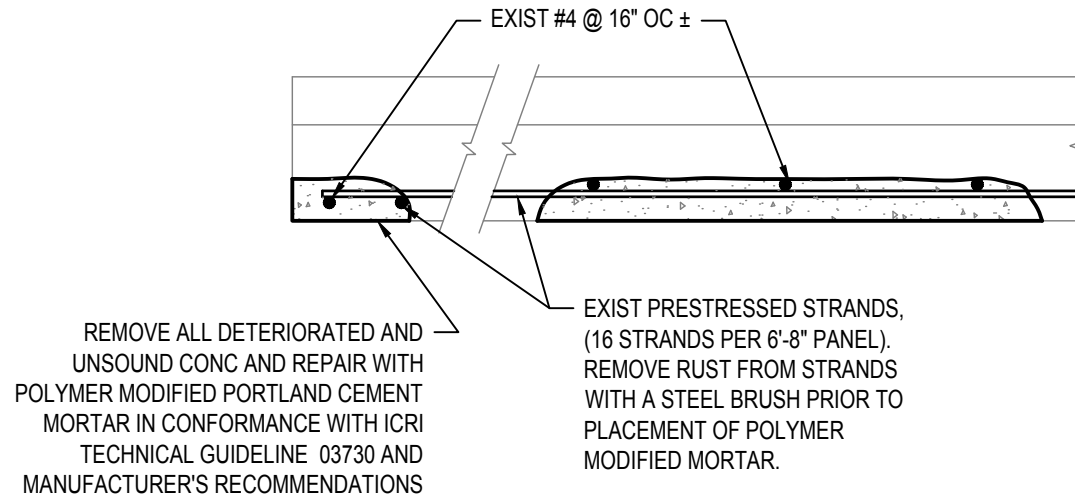

B2 SECTION
NO SCALE

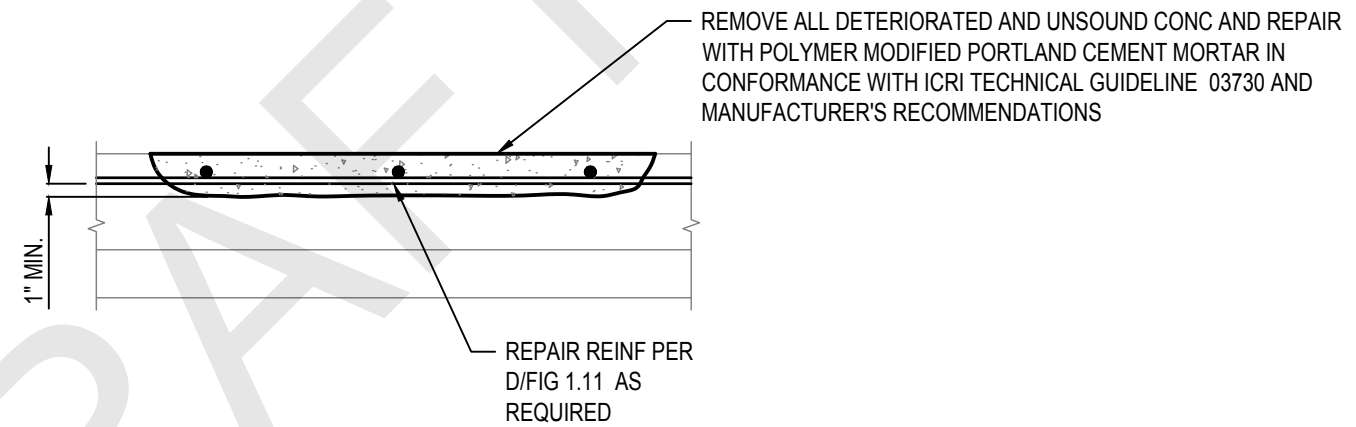

C2 SECTION
NO SCALE

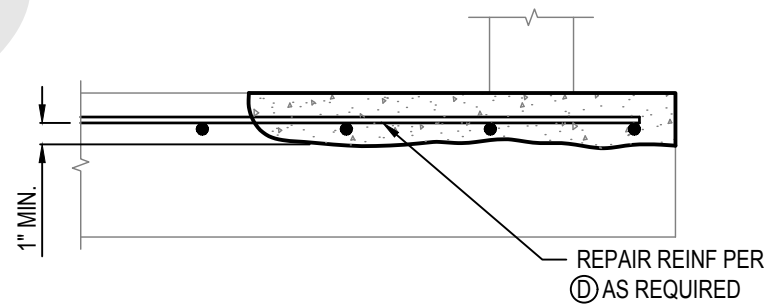

C3 SECTION
NO SCALE

B REPAIR FOR SPALLS AND DELAMINATED AREAS IN SOFFIT OF DECK
NO SCALE

C REPAIR FOR DECK TOP SURFACE
NO SCALE

REPAIR OPTION

REPORT FOR MODIFICATIONS TO THE OCEAN BEACH PIER
SAN DIEGO, CALIFORNIA



1660 HOTEL CIRCLE NORTH, SUITE 500
 SAN DIEGO, CALIFORNIA 92108
 PHONE: (619) 220-6050
 FAX: (619) 220-6055



Fig. No.

FIG 1.10

FILE NAME: 031510487 - ob pier - repair - 1:1.dwg LAYOUT NAME: REPAIR DETAILS - 4 - PLOTTED: Friday, November 30, 2018 - 2:46pm USER: enilliams

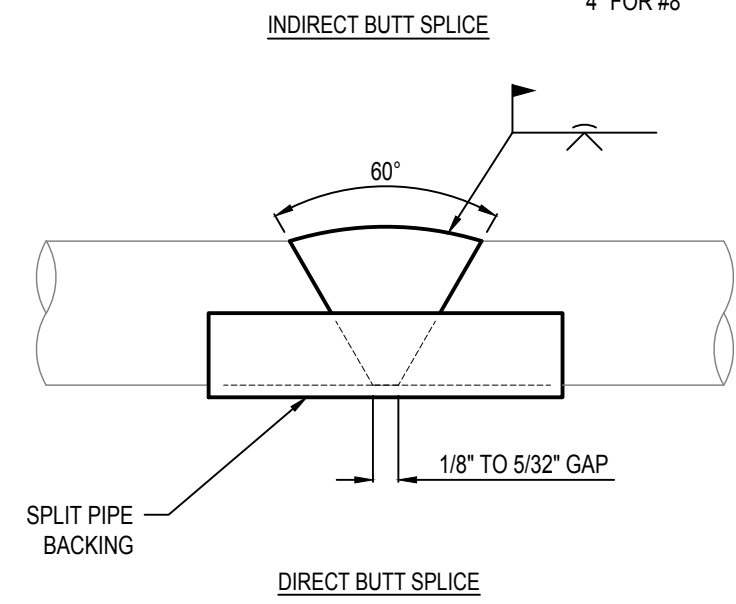
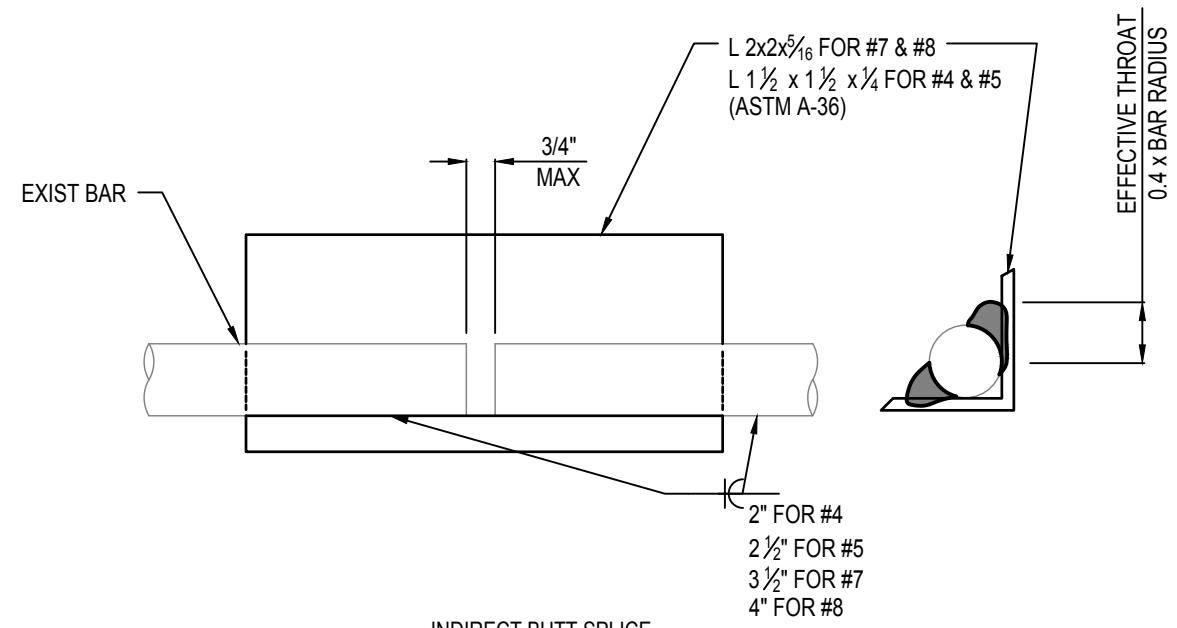

NOTE:
WHERE IT IS FOUND THAT AN EXISTING REINFORCING BAR HAS LESS THAN 80% OF ITS ORIGINAL AREA REMAINING, BAR SHALL BE CUT OUT AND REPLACED WITH A NEW BAR OF THE SAME SIZE. NEW BAR SHALL BE WELDED TO THE EXISTING BAR AS SHOWN.

D REINFORCING WELDING DETAIL
NO SCALE

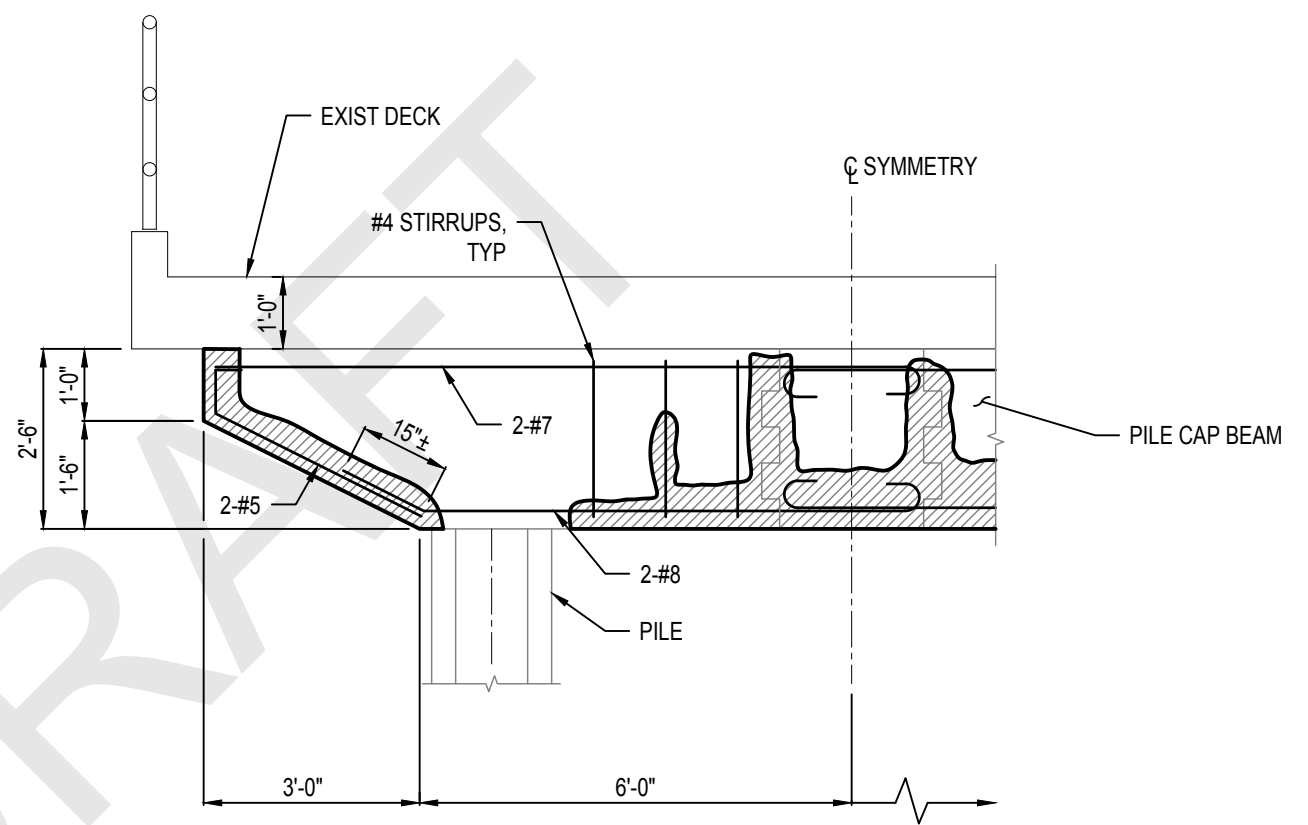

INDICATES PRIMARY AREA OF REPAIR, ALL REINFORCING STEEL SHOWN IS EXISTING

- NOTES:
1. REMOVE ALL DETERIORATED AND UNSOUND CONCRETE AND REPAIR WITH POLYMER MODIFIED PORTLAND CEMENT MORTAR IN CONFORMANCE WITH ICRI TECHNICAL GUIDELINE 03730 AND MANUFACTURERS RECOMMENDATIONS.
 2. REPLACE DAMAGED REINFORCING PER **D** AS REQUIRED.

E TYPICAL PILE CAP REPAIR
NO SCALE

REPAIR OPTION	
REPORT FOR MODIFICATIONS TO THE OCEAN BEACH PIER SAN DIEGO, CALIFORNIA	
	1660 HOTEL CIRCLE NORTH, SUITE 500 SAN DIEGO, CALIFORNIA 92108 PHONE: (619) 220-6050 FAX: (619) 220-6055
	Fig. No. FIG 1.11



PILE CAP DAMAGE

1



PILE CAP DAMAGE

2



PILE DAMAGE

3



PILE DAMAGE

4

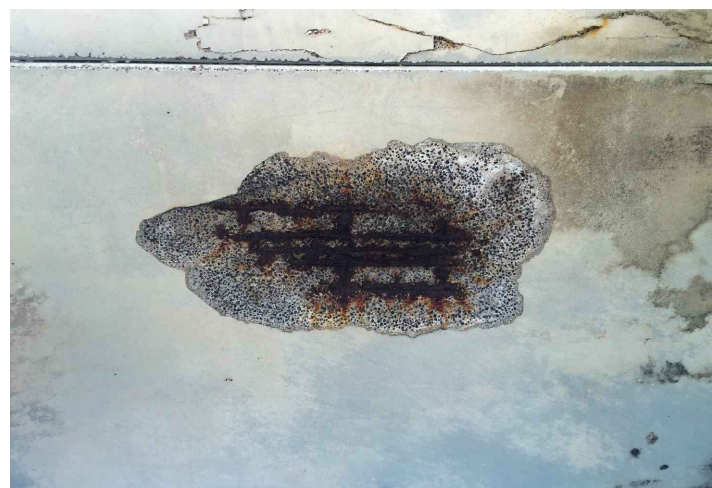

UNDERDECK DAMAGE

5



UNDERDECK DAMAGE

6



LONGITUDINAL BEAM DAMAGE

7

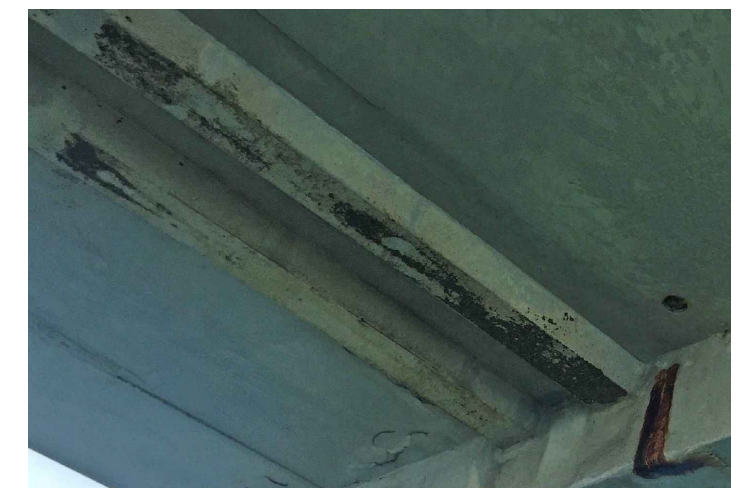

LONGITUDINAL BEAM DAMAGE

8

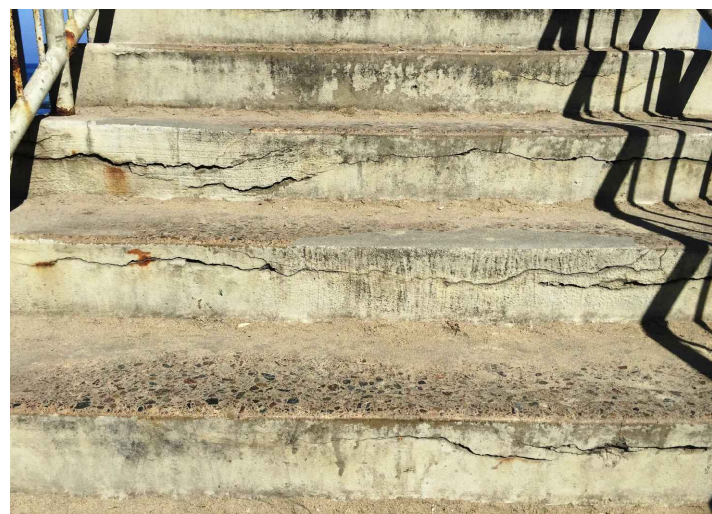

CONCRETE STAIR DAMAGE

9

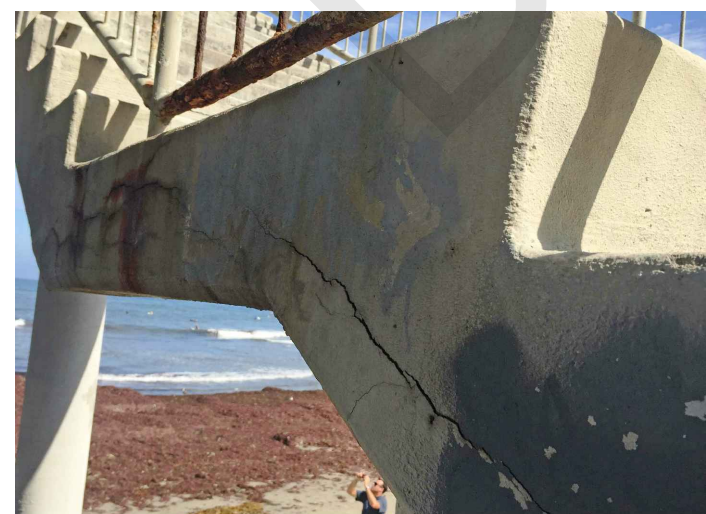

CONCRETE STAIR DAMAGE

10

REPAIR OPTION

REPORT FOR MODIFICATIONS TO THE OCEAN BEACH PIER
SAN DIEGO, CALIFORNIA



1660 HOTEL CIRCLE NORTH, SUITE 500
SAN DIEGO, CALIFORNIA 92108
PHONE: (619) 220-6050
FAX: (619) 220-6055



Fig. No.

FIG 1.12

FILE NAME: 031510487 - ob_pier2 design information\031510487 - ob_pier2 2.1.dwg LAYOUT NAME: OVERALL PLAN AND PROFILE PLOTTED: Friday, November 30, 2018 - 2:49pm USER: anil@ms

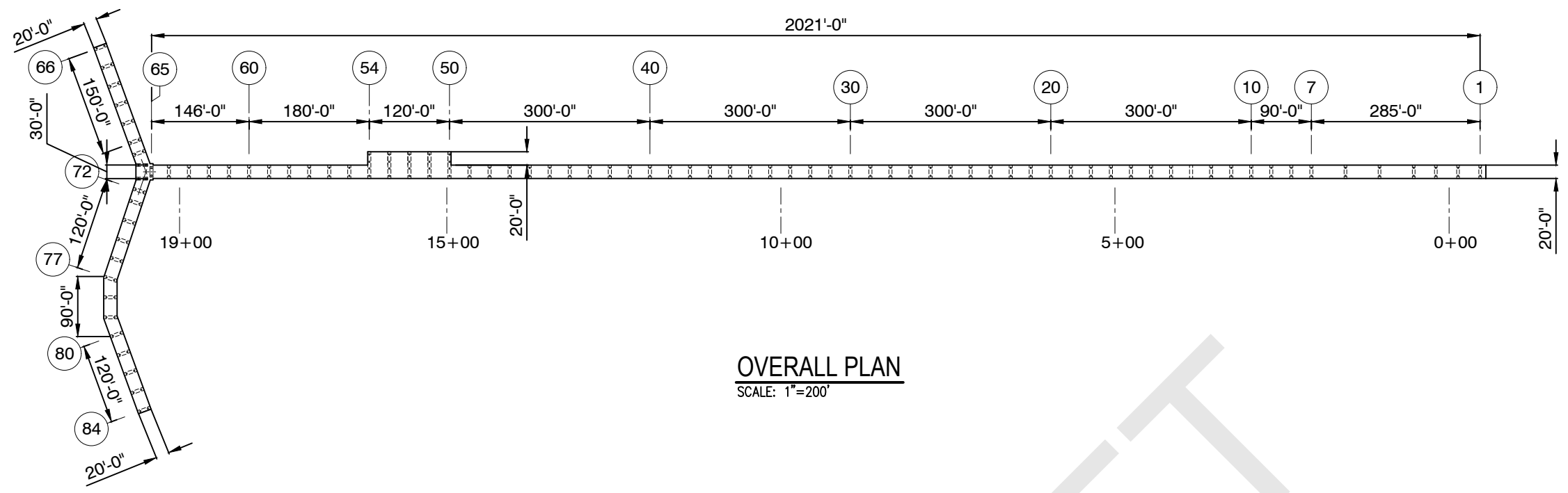

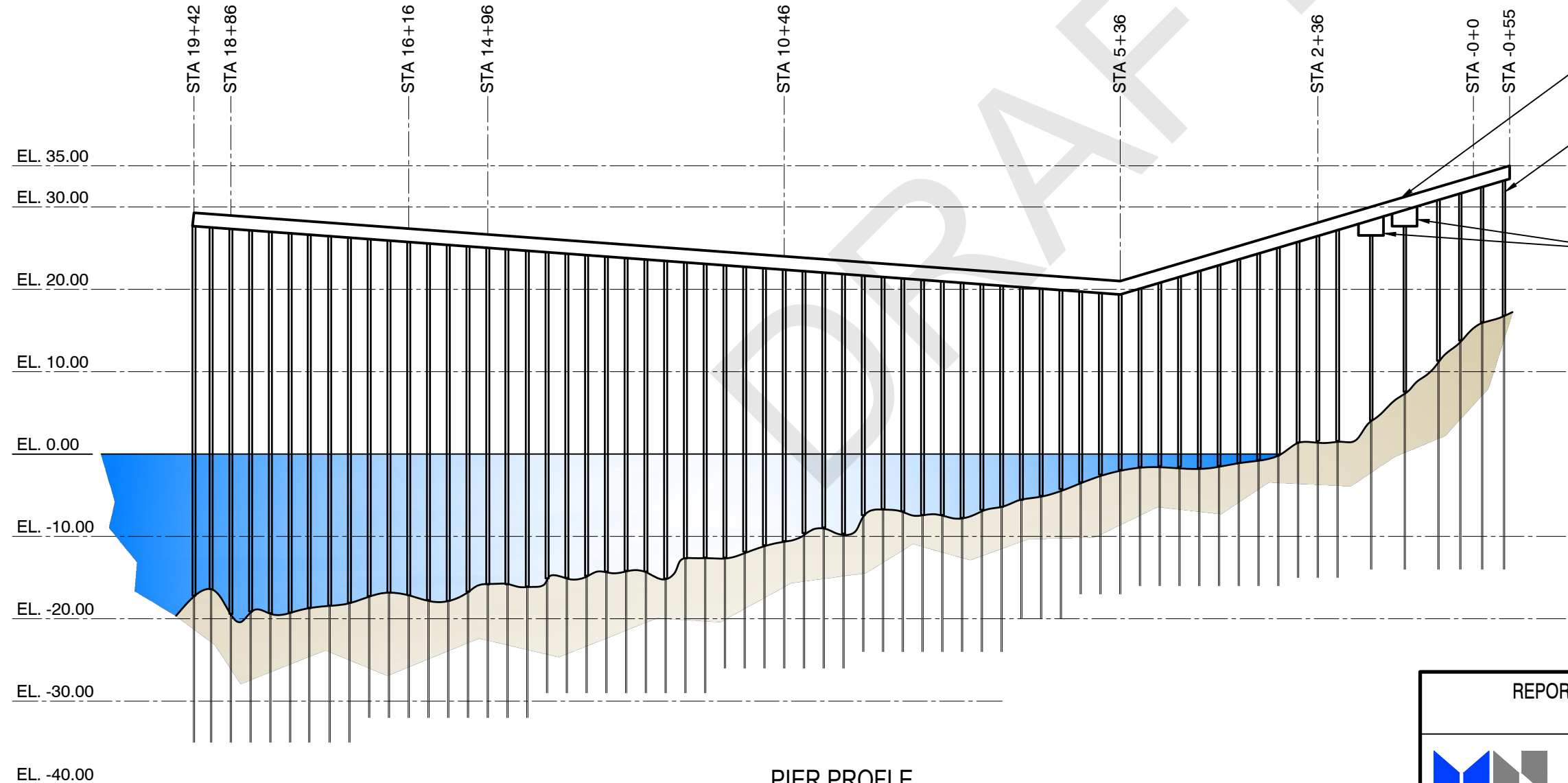

OVERALL PLAN
SCALE: 1"=200'



- NEW DECK PER FIG 2.3
- EXIST CONC PILES WITH NEW CONC PILE JACKETS FULL-HT (FROM MUDLINE TO BOTTOM OF PILE CAP) PER FIG 2.3
- NEW PILE CAP PER FIG 2.2 AND I/FIG 2.3

PIER PROFILE
SCALE: 1"=200'

REHABILITATION OPTION

REPORT FOR MODIFICATIONS TO THE OCEAN BEACH PIER SAN DIEGO, CALIFORNIA		 THE CITY OF SAN DIEGO	Fig. No. FIG 2.1
	1660 HOTEL CIRCLE NORTH, SUITE 500 SAN DIEGO, CALIFORNIA 92108 PHONE: (619) 220-6050 FAX: (619) 220-6055		

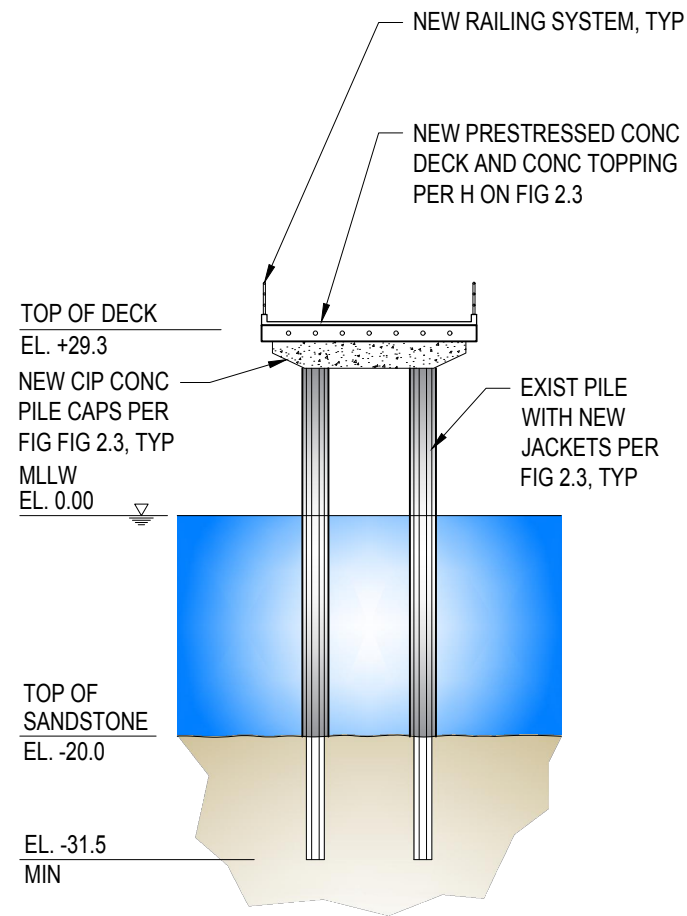

20" PILES

SECTION AT WINDS (END OF PIER)

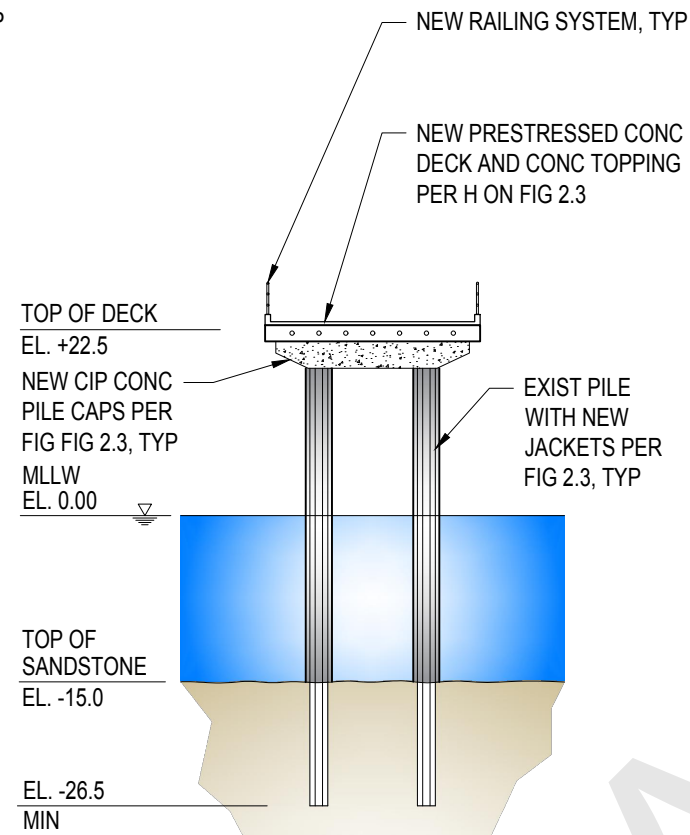

20" PILES

SECTION AT BENTS 47 AND BEYOND

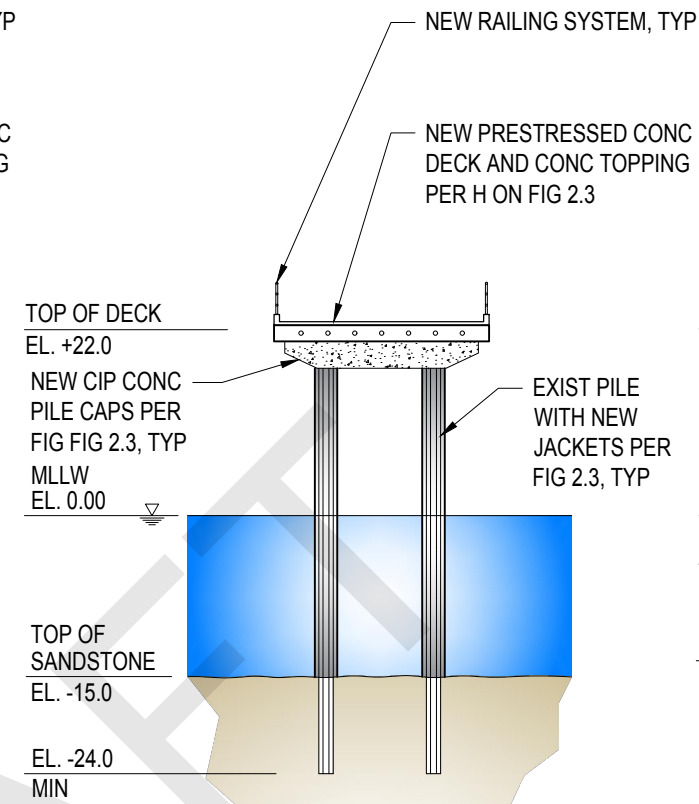

16" PILES

SECTION AT BENTS 22-46

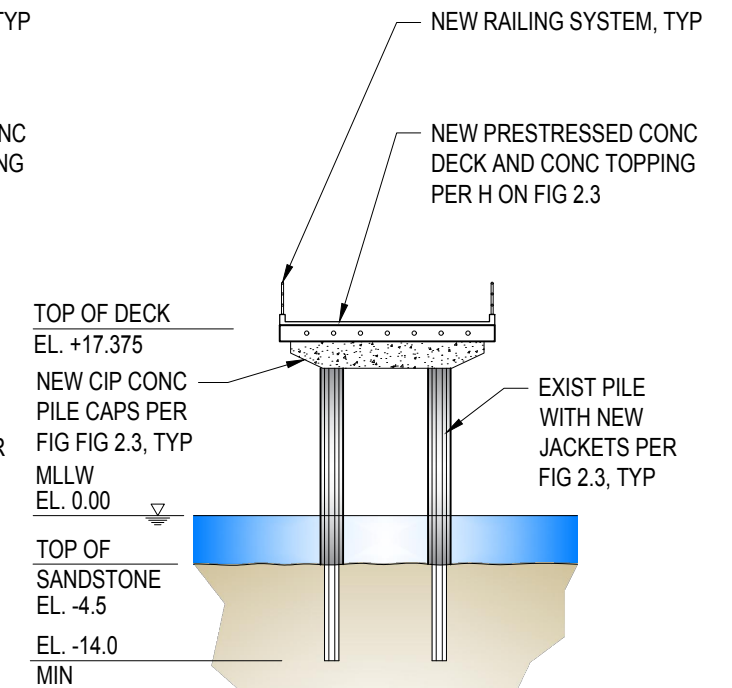

16" PILES

SECTION AT BENTS 1-21

REHABILITATION OPTION

REPORT FOR MODIFICATIONS TO THE OCEAN BEACH PIER
SAN DIEGO, CALIFORNIA



1660 HOTEL CIRCLE NORTH, SUITE 500
SAN DIEGO, CALIFORNIA 92108
PHONE: (619) 220-6050
FAX: (619) 220-6055

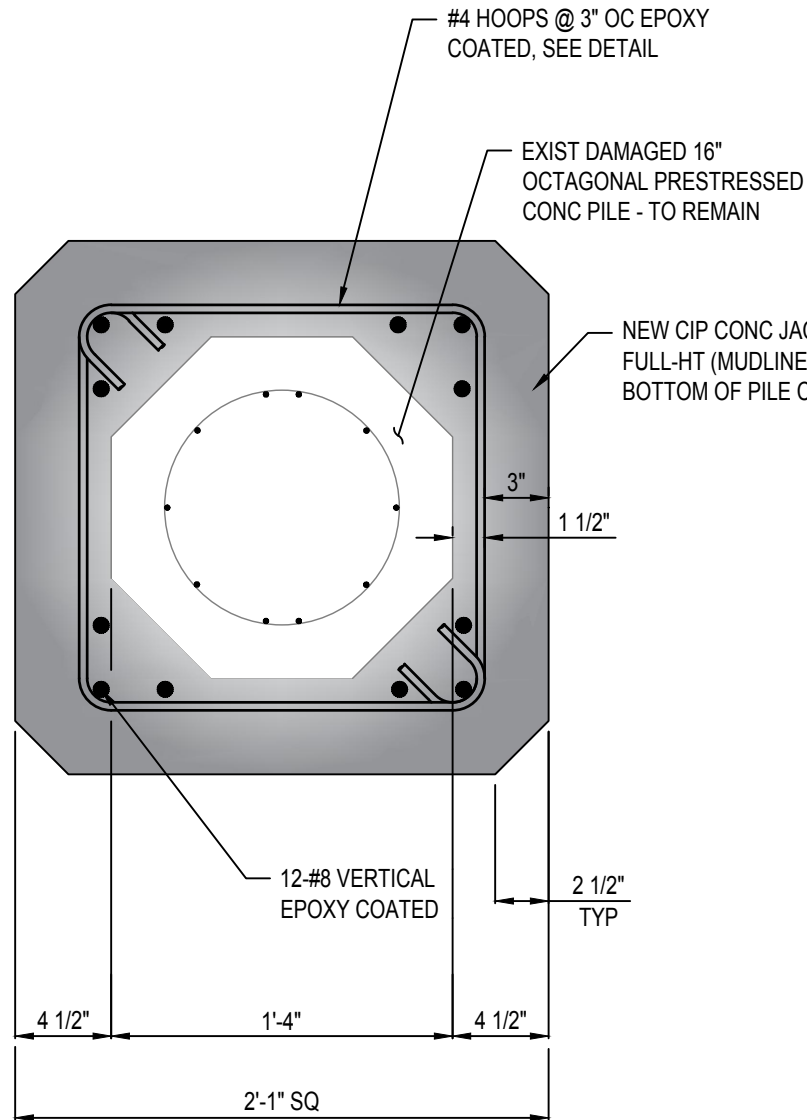

Fig. No.

FIG 2.2

FILE NAME: 013019487 - ob_pier_v design information\000\03 - Rehab\9487_08 Pier - rehab_22.dwg LAYOUT NAME: PIER SECTIONS - PLOTTED: Friday, November 30, 2018 - 2:49pm USER: dwilliams

FILE NAME: 013010487 - ob_pier_v design information\000\03 - Rehab 2.3.dwg LAYOUT NAME: JACKET DETAILS PLOTTED: Friday, November 30, 2018 - 2:48pm USER: dilliams



F NEW 16" PILE JACKET
NO SCALE

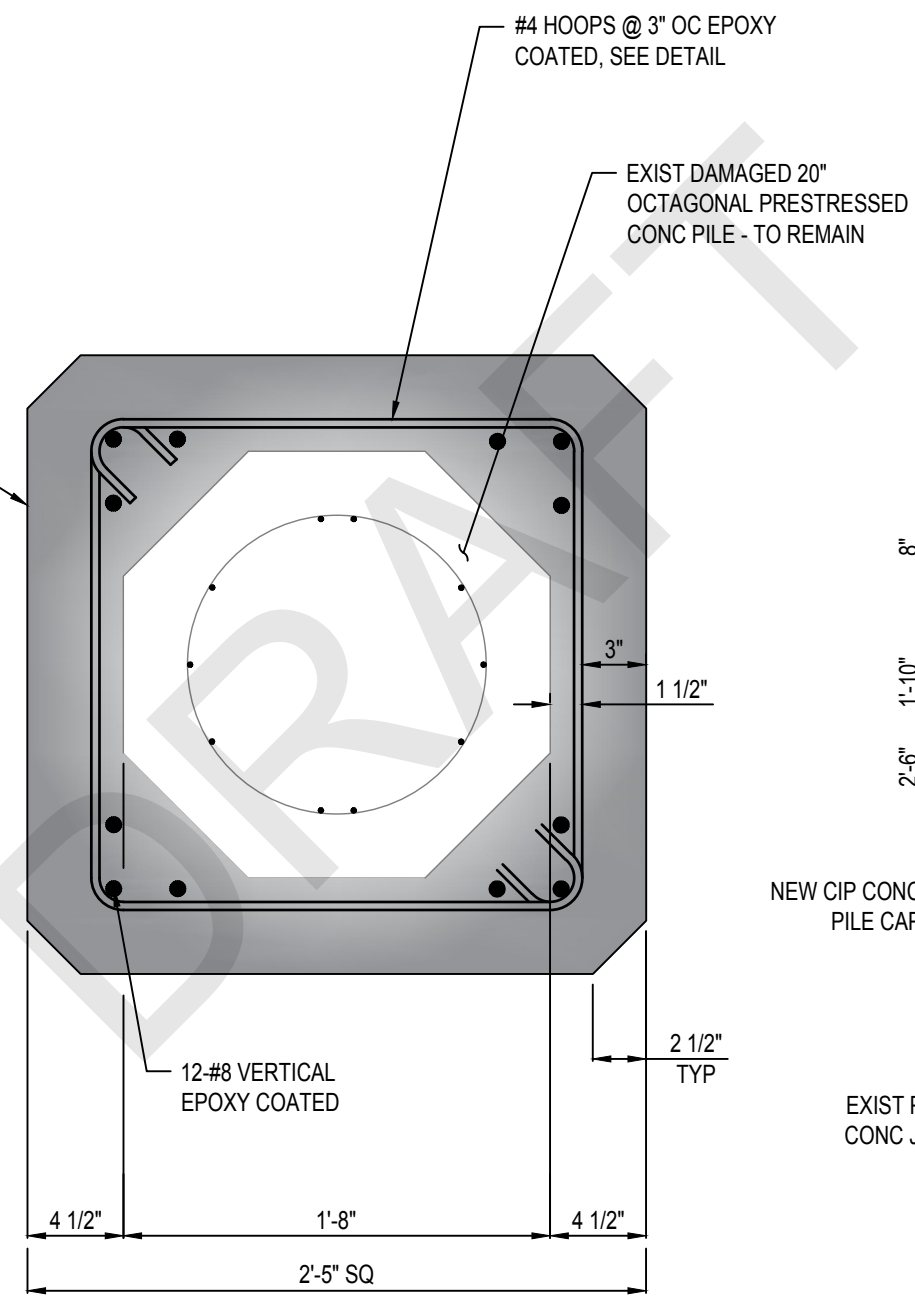

G NEW 20" PILE JACKET
NO SCALE

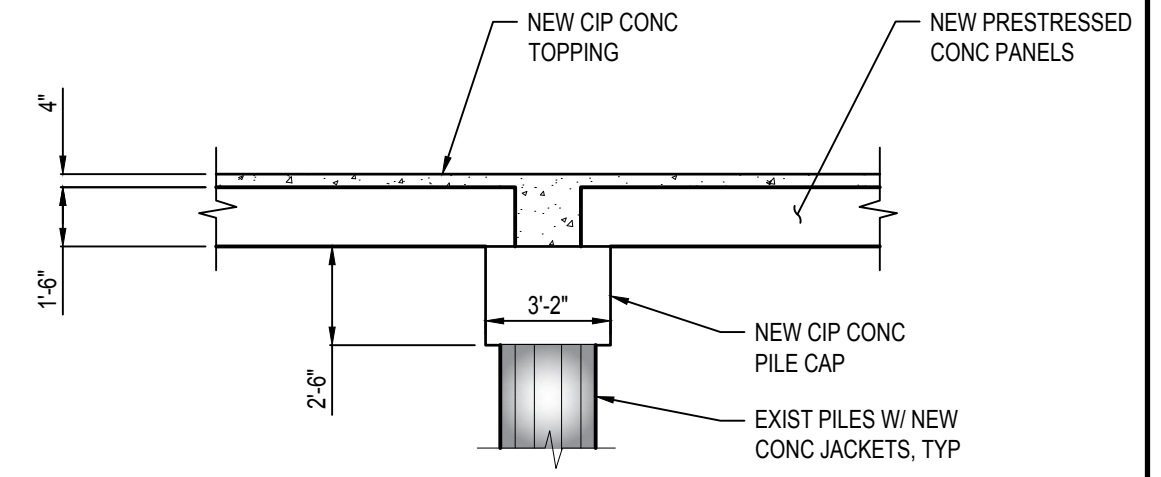

I NEW DECK SECTION
NO SCALE

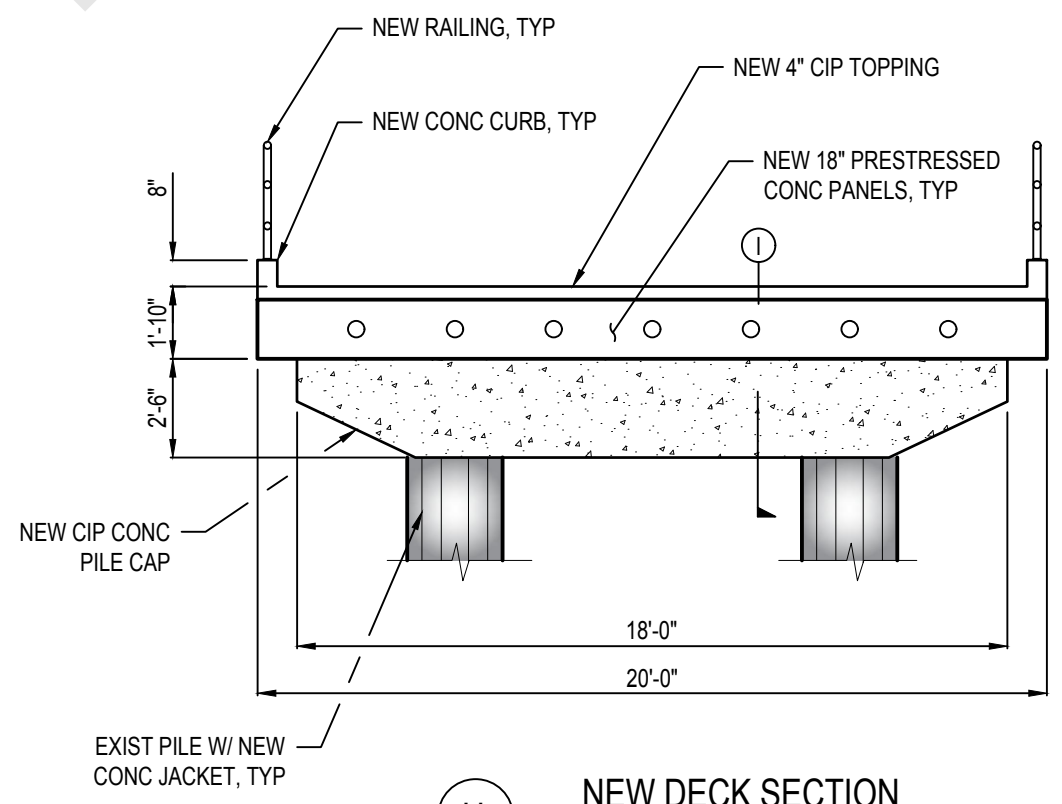

H NEW DECK SECTION
NO SCALE

REHABILITATION OPTION

REPORT FOR MODIFICATIONS TO THE OCEAN BEACH PIER
SAN DIEGO, CALIFORNIA

	1660 HOTEL CIRCLE NORTH, SUITE 500 SAN DIEGO, CALIFORNIA 92108 PHONE: (619) 220-6050 FAX: (619) 220-6055		Fig. No. FIG 2.3
--	-------------------------------------------------------------------------------------------------------------------	--	----------------------------

FILE NAME: 0:\30\487 - ob_pier\design information\ADD\02 - Replacement\487 - ob Pier - replace 3.2.dwg LAYOUT NAME: PIER SECTIONS PLOTTED: Friday, November 30, 2018 - 2:50pm USER: dwilkins

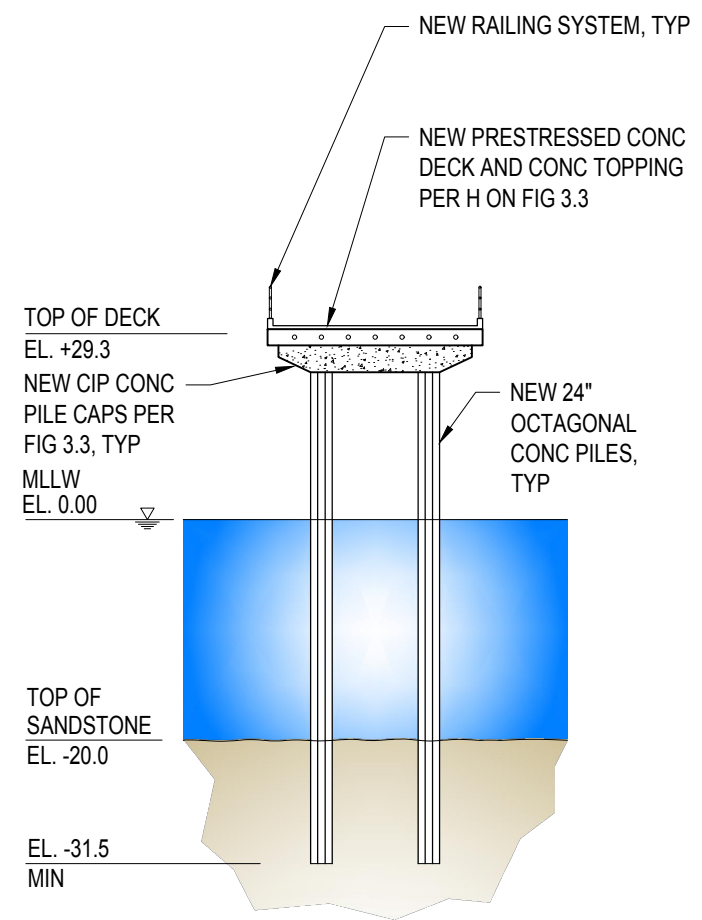

NEW 24" PILES

SECTION AT WINDS (END OF PIER)

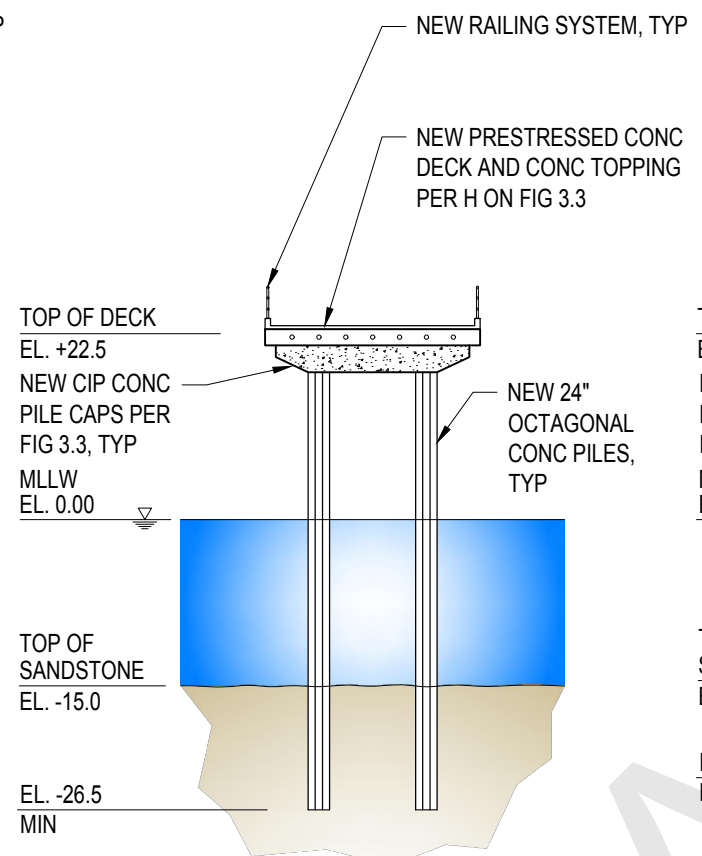

NEW 24" PILES

SECTION AT BENTS 47 AND BEYOND

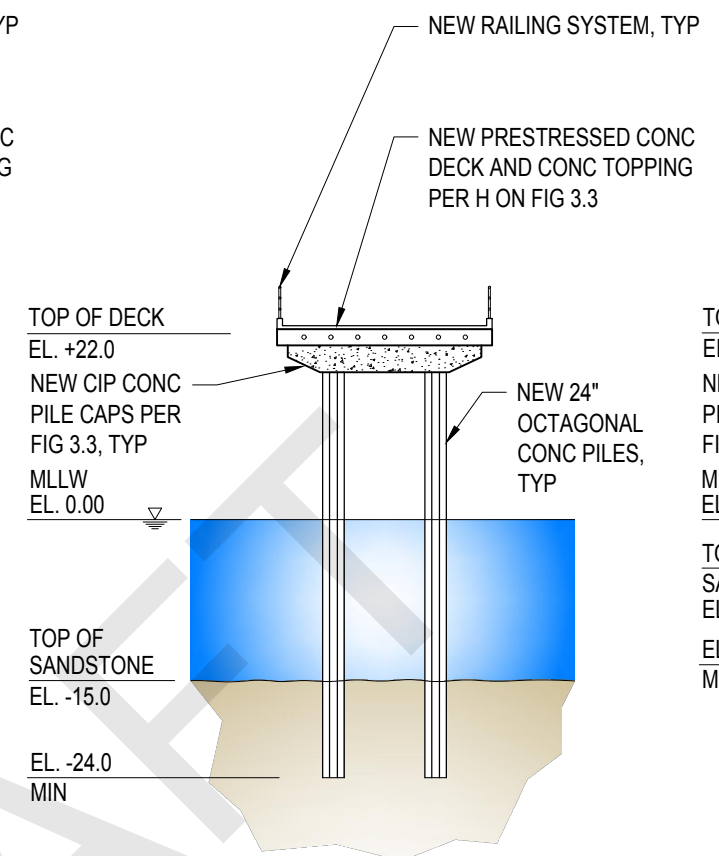

NEW 24" PILES

SECTION AT BENTS 22-46

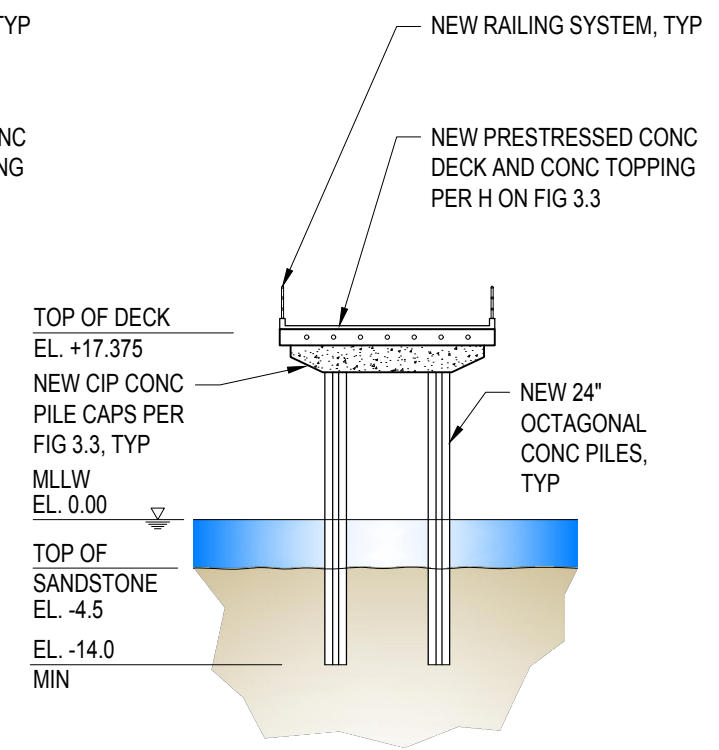

NEW 24" PILES

SECTION AT BENTS 1-21

REPLACEMENT OPTION

REPORT FOR MODIFICATIONS TO THE OCEAN BEACH PIER
SAN DIEGO, CALIFORNIA



1660 HOTEL CIRCLE NORTH, SUITE 500
SAN DIEGO, CALIFORNIA 92108
PHONE: (619) 220-6050
FAX: (619) 220-6055

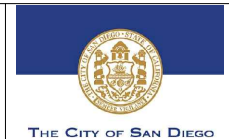
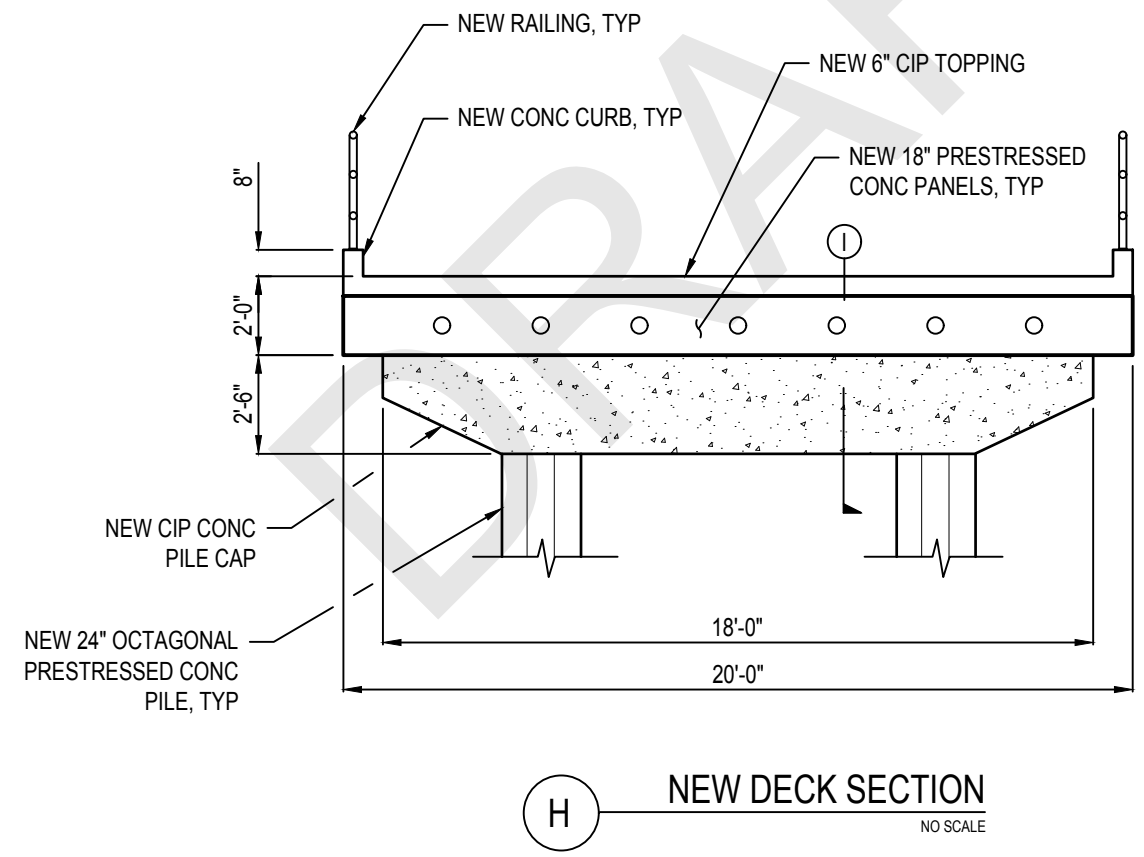
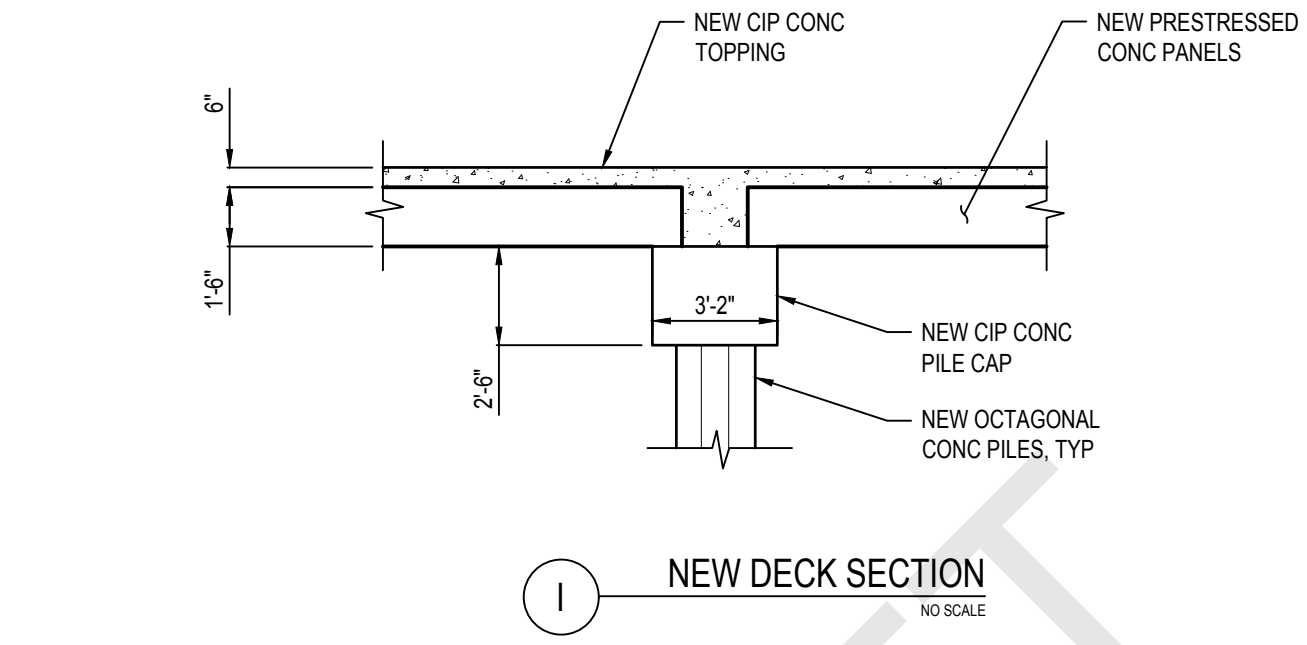

Fig. No.

FIG 3.2



REPLACEMENT OPTION

REPORT FOR MODIFICATIONS TO THE OCEAN BEACH PIER
SAN DIEGO, CALIFORNIA



1660 HOTEL CIRCLE NORTH, SUITE 500
SAN DIEGO, CALIFORNIA 92108
PHONE: (619) 220-6050
FAX: (619) 220-6055



Fig. No.

FIG 3.3

FILE NAME: G:\30\9487 - ob_pier - replace 3.3.dwg LAYOUT NAME: DECK SECTIONS PLOTTED: Friday, November 30, 2018 - 2:50pm USER: dwilliams

APPENDIX B – SERVICE LIFE EVALUATION

Evaluation of Remaining Service Life of Reinforced Concrete Elements of Ocean Beach Pier, San Diego, California

DRAFT



2883 East Spring Street
Suite 300
Long Beach CA 90806
Tel 562.426.3355
Fax 562.426.6424

Evaluation of Remaining Service Life of Reinforced Concrete Elements of Ocean Beach Pier, San Diego, California

Prepared for: Mr. Adam Bogage, PE
Moffatt & Nichol
1660 Hotel Circle North, Suite 500
San Diego, CA 92108

Prepared by: Yiwen Bu, PE, PhD
Director of Concrete Engineering

Executive Summary

Ocean Beach Pier located in San Diego, California was constructed in 1966. Since then, it has been exposed to chloride-enriched, corrosive marine environment. We understand that concerns were raised regarding the condition of the structure. As a part of the investigation addressing the condition, Moffatt & Nichol (**MN**) subcontracted Twining Inc. (**TI**) to perform service life evaluation (as defined in Section "Terminology") according to the simulation protocols of Life-365™.

MN extracted eighteen concrete cores from the pier and provided them to **TI** for chloride analysis and petrographic examination of the compositions of cementitious material blend and water to cementitious material ratio. One objective of Twining's scope of work was to determine if the reinforced concrete elements have exceeded their empirically evaluated service life, and thus needed repair or reconstruction.

The report presents description of the cores, results of analyses and examinations performed, methodology of empirical simulations, and simulation results.

TI sample 14/ **MN** sample 7N - Pile Splash South Side was subject to full-depth chloride analysis. The results indicate that at all depths of the core (including sections from pile and from its encasement), the chloride concentrations (acid-soluble) have exceeded the corrosion initiation threshold of black steel.

Test results of chloride concentrations at reinforcement depths of five core sections extracted from concrete topping of the soffit panels suggest that all have remained below the corrosion threshold of black steel except section from **TI** sample 4/ **MN** sample 55S-Deck.

Service life modeling results for soffit panels, pile caps, and piles (except **TI** sample 14/ **MN** sample 7N) suggest that currently all elements have exceeded their service life expectation, as defined by Life-365, and need major repairs. The modeling results, as could be seen from comparisons between predicted and measured chloride concentrations at the reinforcements, reflected the actual conditions of the elements relatively well in certain elements, while over-estimated the chloride ingress in others. Such over-estimation could be due to the software's over-simplified assumption that diffusion is the dominant mechanism and thus incapacity to capture other factors and mechanisms such drying or loss degree of saturation during service, chloride binding to the cementitious paste, and changes of pore structure due to crystallization of salts. The overestimation in soffit panel and deck elements could also be due to that the effects of the intermediate repair could have not be accounted for.

Terminology

Propagation Period: The time period from corrosion initiation to the time when major repairs become necessary.

Service Life: The service life of reinforced concrete elements, as defined in Life-365 and used in this report, is the time exceeding which major repairs become necessary. It is the sum of time to corrosion initiation and the propagation period

DRAFT

1. Introduction

Mr. Adam Bogage, PE of Moffatt & Nichol (**MN**) requested Twining Inc. (**TI**) to evaluate the remaining service life of reinforced concrete elements in Ocean Beach Pier, San Diego constructed in 1966. These elements include pre-stressed concrete piles, precast pile caps, and precast pre-stressed soffit panels in five different locations (7N, 17N, 44S, 55S, and 72S) along the span of the pier (design strength provided by **MN** and indicated in Table 1 below). The purpose of this evaluation is to determine whether the reinforced concrete elements under investigation have exceeded their empirically evaluated service life, and thus need repair or reconstruction.

Table 1 Design Strength of Concrete Elements

Types of Element	Design Strength (psi)
Precast pre-stressed soffit panels	5,000 psi @ 28 days
Pre-stressed pile caps	3,250 psi @ 28 days
Precast piles	5,000 psi @ 28 days

On April 7, 2017, **TI** picked up 18 concrete cores from **MN** (sample identifications and conditions as received listed in Appendix A). These cores were tested to obtain input parameters for service life modeling using Life-365 except for **TI** sample 14 (**MN** sample 7N – Pile Splash), of which only a full-depth chloride profile is requested. Testing were performed at the San Diego laboratory of **TI**, Chemistry of Concrete (**CC**), and DPR, a Twining company (**DRP**) as discussed below. Service life modeling was subsequently performed by **TI** for piles, pile caps, and the soffit panels of the pier decks using Life-365. The cores extracted from pier decks also consist of sections of the cast-in-place concrete toppings above the soffit panels. Service life modeling is not performed on this cast-in-place concrete topping.

2. Service Life Modeling Approach

Life-365™ (developed by the Life-365 Consortium I and II groups of companies) was used to predict the chloride ingress and service life of the reinforced concrete elements. The model is based on Fick's second law, assuming that there are no cracks in the concrete and that diffusion is the dominant mechanism. The chloride profile at any given time is calculated with a finite difference approach¹.

The input parameters required for the modeling are presented in Table 2 below, as well as available options in determining the input values.

¹ Life-365 user manual: www.life-365.org/download/Life-365_Users_Manual.pdf

Table 2 Input Parameters and Options for Life-365

Input Parameters	Option 1 - Default		Option 2 - User Input		Adopted Option
	Availability	Associated Input	Availability	Test Protocol or Reference	
Element Types and Dimensions (inch)	Default values not provided		Available	Record Drawings	User Input
Types and Depths of Reinforcement (inch)	Default values not provided		Available	Record Drawings	User Input
Average Monthly Temperature (°F)	Available	Geographic location	Available	Historical data provided by NOAA	User Input
Maximum Surface Chloride Concentration (lb/yd ³)	Available	Geographic and element location	Available	Testing of surface profiles per ASTM C1556	User Input
Rate of Surface Chloride Build-up (years)	Available	Geographic and element location, application of membranes or sealers	Available	Periodic testing of surface chloride concentration during first five years of service	Default
Diffusion Coefficient of Chloride at 28 days (in ² /s)	Available	Concrete mix proportions (w/cm, %fly ash, %slag, and %silica fume)	Available	Testing of apparent diffusion coefficient per ASTM C1556 at 28 days	Default and User Input
Diffusion Decay Index	Available	Concrete mix proportions (%fly ash and %slag)	Available	Testing of apparent diffusion coefficient at 28 days, 1 years, and 5 years	Default
Corrosion Initiation Threshold (% wt of concrete)	Available	Types of reinforcement, type and dosage of corrosion inhibitors	Available	Testing per ASTM G109	Default
Propagation Period (years)	Available	Types of reinforcement	Available	Testing per ASTM G109	Default

We have adopted only the default values for rate of surface chloride build-up, diffusion decay index, corrosion initiation threshold, and propagation period for the reason that the recommended test protocols to obtain user inputs could not be performed. In the case of surface chloride build-up and diffusion decay index, the subject concrete in place has already exceeded the latest age for testing. In the case of corrosion initiation threshold and propagation period, reinforcement samples that have not been exposed to corrosive environment are not available to perform the recommended testing (ASTM G109).

We have selected element types and dimensions, types and depths of reinforcement based on record drawings and information provided by **MN**. The input values for monthly average temperatures of the project location are in accordance with the historical data provided by NOAA for San Diego, California. To obtain the input values for surface chloride concentration, we have performed testing of surface chloride profiles per ASTM C1556. To determine input values for diffusion coefficient, petrographic examination per ASTM C856 and testing of apparent chloride diffusion coefficient per ASTM C1556 were performed. The detailed test procedures and test results are explained in the Section 3.

3. Test Procedures and Results

3.1 Petrographic Examination

One objective of petrographic examination is the evaluation of water to cementitious material ratio. **TI** and **DRP** determined that the portions of the cores least affected by the environment are most suitable for this objective. Therefore the examination was performed using 1-inch thick section of cores saw cut from the end, which in service was least subject to the exposure to ocean environment.

The cores were labeled by **MN** as 44S-Deck, 17N-Pile Cap West Side, and 44S-Pile 38" from Cap. These cores were randomly selected to represent soffit panels, pile caps, and piles respectively. These core sections were transferred to **DPR** on May 11, 2017 for petrographic examination of water to cementitious ratio (w/cm), presence and content of fly ash, slag cement and silica fume (ASTM C856). The results are presented in Table 3 and Appendix B, and were used as inputs characterizing concrete mix proportions.

Table 3 Petrographic Examination Results of w/cm and content of supplementary cementitious materials

TI Sample ID	MN Sample ID	Type of Element	w/cm		Content of fly ash, slag cement and silica fume
			Lower Limit	Higher Limit	
3	44S-Deck	Soffit Panels	0.45	0.55	0% for all
7	17N-Pile Cap West Side	Pile Caps	0.50	0.60	0% for all
16	44S-Pile 38	Piles	0.45	0.55	0% for all

3.2 Testing of Surface Chloride Profiles and Chloride Concentrations at Locations of Reinforcement

The outermost (from the side exposed to ocean environment) 3-inch sections of each concrete core received (except **TI** sample 14/**MN** sample 7N – Pile Splash, see section 3.3) were transferred to **CC** for analysis of surface chloride profiles and chloride concentrations at depths of reinforcement.

The acid-soluble surface chloride profiles are determined at each depth per ASTM C1152, and in accordance with the number of data points and depth intervals suggested by Life-365 and ASTM C1556. Since ASTM C1556 recommends depth intervals by w/cm, we have selected the conservative intervals corresponding to w/cm = 0.50 for soffit panels and pile elements, and w/cm = 0.70 for pile cap elements. These values of w/cm were estimated based on the design strength of the elements (Table 1) and were selected before the petrographic examination results become available. However, it could be seen that these estimation either fall within the range determined by petrographic examination (soffit panels and piles), or provide a more conservative coverage (pile caps). Test results of surface chloride profiles are presented in Appendix C (report by **CC**). These results were used in Life-365 to estimate maximum surface chloride concentrations.

Testing of acid-soluble chloride content (ASTM C1152) was also performed at the measured depths of reinforcement, or where reinforcement was not observed, at the design depths provided by **MN** (Table 4). Results of chloride content and visual observations of reinforcement are shown in report by **CC** in Appendix D.

*Table 4 Design Depth of Reinforcements provided by **MN***

Type of Element	Design Depth of Reinforcement (inches)
Piles	2.75
Pile Caps	2.50
Deck - Topping	1.50
Deck - Soffit	1.75

3.3 Testing of Full-Depth Chloride Profiles for **TI** sample 14/**MN** sample 7N – Pile Splash

Chloride profiles were determined for **TI** sample 14/ **MN** sample 7N – Pile Splash. This core sample consists of sections from pile element (~ 2.5 inches) and its encasement (~4 inches). The acid soluble chloride profiles were determined per ASTM C1152 and in the increment of 0.5 inches for the full depth of both sections of the core. Table 13 and 14 of Appendix C (report by **CC**) present the results of this testing. As acknowledged by **TI** and **MN**, this testing was sufficient and no service life modeling was performed for this particular element.

3.4 Testing of Apparent Chloride Diffusion Coefficients

For each concrete element, two representing cores were selected for the determination of apparent chloride diffusion coefficient (D_a) at the current age of 61 years. The innermost 3 inches (opposite to the side exposed to ocean environment) of these six concrete cores (MN samples 7N-Deck, 72S-Deck, 44S-Cap, 72S-Cap, 7N-Pile Top, and 72S-Pile Top) were cut, coated with epoxy, and conditioned per ASTM C1556. These samples were then submerged in NaCl solutions (165 ± 1 g/L) at 73 ± 4 °F for 35 days. After exposure, samples were transferred to **CC** for testing of chloride profiles and determination of apparent chloride diffusion coefficient. Test report by **CC** is included in Appendix E. For each element, average result of D_a at 61 years were used to estimate diffusion coefficient of chloride at 28 days. This is further explained in Section 4.

4. Service Life Modeling Inputs

4.1 Element Types and Dimensions

For the service life modeling of soffit panels, piers and pier caps, the element type selected from the available options (slabs and walls, square columns/beams, circular columns) was the one matching most closely the geometry of the actual. The dimension of the elements were entered according to the record drawings provided by **MN**. Table 5 below summarizes these two inputs.

Table 5 Types and Dimensions of Elements used for Modeling

Actual Type of Element	Modeled Type of Element	Dimensions of Element (inch)
Soffit Panels	Slabs and walls	9.0
Pile caps	Slabs and walls	12.0
Piles	Circular columns	20.0

4.2 Types and Depths of Reinforcement

The type of reinforcements was selected as black steel for all elements according to the record drawings. The modeled depths of reinforcement were as measured when they were observed or otherwise as design depths presented in Table 4. In both cases, the depths were rounded down to the nearest 0.1 inches to be conservative and to be compatible with the number of digits allowed by Life-365 (Table 6).

4.3 Average Monthly Temperatures

The input values of average monthly temperatures for the project site were based on the historical climate data provided by NOAA for San Diego, California, and are listed in Table 7 below.

Table 6 Depths of Reinforcement used for Modelling

TI Sample ID	MN Sample ID	Depth of Reinforcement (inches)
1	7N - Deck	1.7 (design)
2	17N - Deck	1.7 (design)
3	44S - Deck	1.7 (design)
4	55S - Deck	1.6 (measured)
5	72S - East Deck	1.7 (design)
6	7N - Cap	2.5 (design)
7	17N - Pile Cap West Side	2.5 (design)
8	44S - Cap	2.5 (design)
9	55S - Pile Cap	2.5 (design)
10	72S - Cap EN. Side of Cap	2.5 (design)
11	7N - Pile Top North Side	2.2 (measured)
12	55S - Top Pile	2.2 (measured)
13	72S - East Pile Tops	1.8 (measured)
14	7N - Pile Splash South Side	Not modeled
15	17N - 68" Below Pile	2.2 (measured)
16	44S - Pile 38" from Cap	2.3 (measured)
17	55S	1.7 (measured)
18	72S - East	2.1 (measured)

Table 7 Average Monthly Temperatures used for Modeling

Months	Average Monthly Temperature (°F)
January	56.5
February	57.5
March	58.9
April	61.1
May	63.4
June	65.9
July	69.6
August	71.0
September	69.8
October	66.1
November	61.4
December	57.3

4.4 Maximum Surface Concentrations

The surface chloride profiles presented in Appendix C were used as inputs in Life-365 to determine the fitted maximum surface chloride concentrations. The fitting approach adopted by Life-365 is a non-linear, least-square regression method. The fitted values of maximum surface chloride concentration are presented in Table 8 below.

Table 8 Fitted Maximum Surface Chloride Concentrations by Life-365

TI Sample ID	MN Sample ID	Fitted Maximum Surface Concentration (% weight of concrete)
1	7N - Deck	0.958
2	17N - Deck	1.617
3	44S - Deck	0.646
4	55S - Deck	0.704
5	72S - East Deck	0.546
6	7N - Cap	0.387
7	17N - Pile Cap West Side	0.810
8	44S - Cap	0.353
9	55S - Pile Cap	0.400
10	72S - Cap EN. Side of Cap	0.407
11	7N - Pile Top North Side	0.302
12	55S - Top Pile	0.581
13	72S - East Pile Tops	0.361
14	7N - Pile Splash South Side	Not Modeled
15	17N - 68" Below Pile	0.511
16	44S - Pile 38" from Cap	0.480
17	55S	0.461
18	72S - East	0.643

4.4 Diffusion Coefficients of Chloride at 28 Days

The values for diffusion coefficient of chloride at 28 days (D_{28D}) were either: (1) calculated per Life-365 according to the concrete mix proportions, more specifically w/cm, percentage of fly ash, slag, and silica fume; or (2) calculated from the test results of apparent diffusion coefficient per ASTM C1556 at the age of 61 years (D_{61Y}).

The calculation of D_{28D} from D_{61Y} is based on the relationship used by Life-365 and presented in Equation 1 below:

$$D_{(t)} = D_{28D} \cdot \left(\frac{28 \text{ Days}}{t}\right)^m \quad \text{Equation 1}$$

Where $D_{(t)}$ = diffusion coefficient at time t (days),
m = diffusion decay index, default value of 0.2 for Portland cement concrete mix containing no fly ash or slag.

The reduction of diffusion coefficient with time as expressed in Equation 1 is due to the increased degree of hydration and densified microstructure as concrete matures. Life-365 assumes that hydration is complete at 25 years and therefore diffusion coefficient will remain constant from that point on, or that:

$$D_{61Y} = D_{25Y} = D_{28D} \cdot \left(\frac{28 \text{ Days}}{t}\right)^m \quad \text{Equation 2}$$

Equation 2 above enables us to back calculate the value of D_{28D} based on the test results of D_{61Y} . The calculated values of D_{28D} using this approach are listed in Table 9 together with the values estimated by Life-365 based on petrographic examination results of concrete mix proportions (w/cm, percentage of fly ash, slag, and silica fume).

Table 9 Values of Diffusion Coefficients of Chloride at 28 Days used for Modeling

Type of Element	D _{28D} by Concrete Mix Proportions (×10 ⁻⁷ in ² /sec)		D _{28D} by test results of D _{61Y} (×10 ⁻⁷ in ² /sec) (D _{28D-61Y})
	Lower limit (D _{28D-L})	Higher Limit (D _{28D-H})	
Soffit Panels	1.623	2.821	7.094
Pile caps	2.140	3.718	10.034
Piles	1.623	2.821	17.923

It could be seen that the values of D_{28D} calculated from test results of D_{61Y} ($D_{28D-61Y}$) are higher than the range of D_{28D} estimated (D_{28D-L} - D_{28D-H}) by Life-365 according to results of petrographic analysis. With all other input parameters remaining the same, this will lead to a shorter estimated service life and higher predicted chloride concentration at the depth of reinforcement. All three values were used during the service life modeling of each element.

4.5 Default Values and Assumptions

The default values used for service life modeling were the same for all elements and are listed in Table 10.

Table 10 Default Values for Modeling

Input Parameters	Default Values
Rate of Surface Chloride Build-up	10 years (assuming no membranes or sealers are used)
Diffusion Decay Index (m)	0.2
Chloride Threshold for Black Steel	0.05% by weight of concrete for normal weight concrete (~146 lbs/yd ³).
Propagation period for Black Steel	6 years

Please note that the chloride threshold for black steel was adjusted to 0.063% by weight of concrete for light weight soffit panels, due to that the design unit weight was 115 lbs/yd³ as opposed to the assumed unit weight of 146 lbs/yd³ by Life-365.

To account for the effects of corrosion inhibitors, Life-365 increases the corrosion initiation threshold according to the type and dosage rates used. During the modeling of all elements, it was assumed that no corrosion inhibitors (calcium nitrate or organic inhibitor) were incorporated into the concrete mix, since no such requirements were indicated on the structural drawings available to us, nor are such admixtures likely to be available at the time of construction (1966) according to the knowledge of **TI** and **MN**.

It has come to our attention that during the repairs of the pier in 1990, a coating (unidentified type) was applied to the bottom of the soffit panels and to the circumference of the piers. However, Life-365 currently does not have the capacity to model the effects of coatings after 24 years in service. It was therefore assumed in all modeling that no membrane or sealer was applied for the entire service duration of soffit panel and pier elements. This assumption was expected to result in a more conservative estimation of service life for these elements. The same assumption was made for pile cap elements, as the structural drawings available to us do not specify membrane or sealer applications.

5. Findings

5.1 Full-depth Chloride Profile for TI Sample 14/ MN Sample 7N - Pile Splash South Side

Full-depth chloride profiles for **TI** sample 14 as reported in Appendix C and Table 11 below show that at all depths analyzed, chloride concentrations have exceeded the corrosion initiation threshold for black steel (0.05% by weight of normal concrete) in sections extracted from both pile and its encasement.

*Table 11 Full-depth Chloride Profiles for **TI** Sample 14/ **MN** Sample 7N - Pile Splash South Side*

Depth (inches)	Measured Chloride Concentrations (wt% of concrete)
Pile Section	
0.25	0.537
0.75	0.586
1.25	0.550
1.75	0.546
2.25	0.529
Encasement Section	
0.25	0.599
0.75	0.618
1.25	0.354
1.75	0.173
2.25	0.122
2.75	0.222
3.25	0.286
3.75	0.401

5.2 Measured Chloride Concentration at Reinforcements – Concrete Topping of Soffit Panels

The measured chloride concentrations at reinforcement depth (design or measured) of concrete topping for soffit panels are presented in Table 12. It could be seen that the chloride concentrations at the reinforcement are currently below the corrosion initiation threshold for black steel (0.05% by weight of normal concrete) except for **TI** sample 4-Topping. However, the embedded portion of the rebar in **TI** sample 4-Topping revealed no visible sign of corrosion. The rebar embedded in **TI** sample 3-Topping, on the other hand, showed scattered corrosion spots near core surface. Reinforcements were not observed in other concrete topping sections.

Table 12 Measured Chloride Concentrations at Reinforcements of Deck Topping

TI Sample ID	MN Sample ID	Depth of Reinforcement (inches) and visual observations	Measured Chloride Concentrations at Reinforcement (%wt of concrete)
1-Topping	7N - Deck	1.5 (design)	0.024
2-Topping	17N - Deck	1.5 (design)	0.035
3-Topping	44S - Deck	2.88 (measured, scattered corrosion spot near the surface of the core)	0.029
4-Topping	55S - Deck	1.75 (measured, no visible signs of corrosion)	0.059
5-Topping	72S - East Deck	1.5 (design)	0.012

5.3 Service Life Modeling Results

Life-365 estimates the chloride concentration vs. depth at the current service duration of 61 years (Figure 1a), and chloride build-up at the designated depth of reinforcement over the years (Figure 1b). Such predictions are presented for all 17 elements modeled in Appendix F. The service life of each element is predicted by Life-365 as the time of corrosion initiation (when the chloride concentration at the reinforcement reaches the corrosion initiation thresholds for black steel) plus the propagation period (default value of 6 years for black steel). These predictions are presented below for each type of element (soffit panels, pile caps, and piles). The predicted concentrations of chloride at the reinforcement level are also compared with the measured concentrations presented in Appendix D.

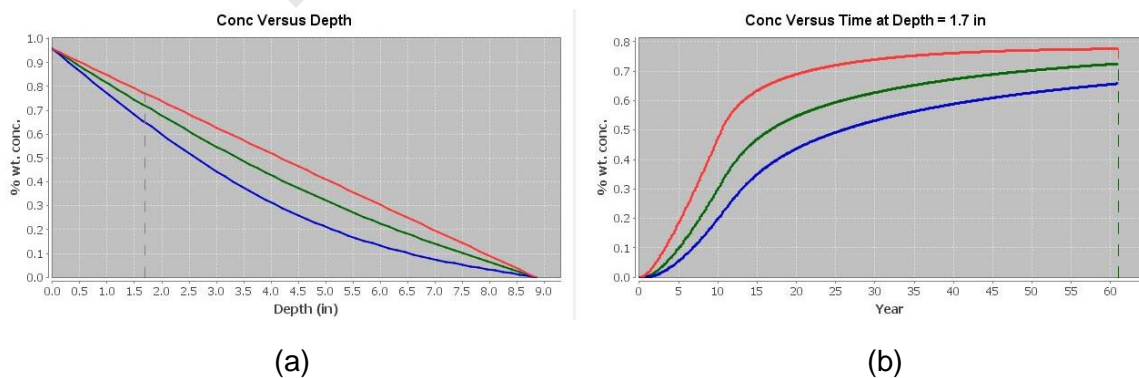

Figure 1 Example of Life-365 Modeling Outputs

5.3.1 Soffit Panels– Service Life Modeling Results

Table 13 below presents the estimated service life and chloride concentrations at the reinforcement of five soffit panel elements. It could be seen that the estimated service life ranges between 8.4 – 12.4 years, varying between elements and depending on the values of diffusion coefficient used (D_{28D-L} , D_{28D-H} , $D_{28D-61Y}$). The predicted chloride concentration (acid-soluble) at the reinforcement ranges between 0.36 -1.31%. The model prediction shows general agreement with the measured chloride concentrations for **TI** sample 2 and 5. For **TI** sample 1, 3, and 4, the model over-predicts the chloride concentrations at the reinforcement.

Both the predicted and measured chloride concentrations at reinforcement for all five soffit panel elements exceeded the corrosion initiation threshold of 0.063% (by weight of lightweight concrete).

Embedded steel cables in **TI** sample 4 showed scattered corrosion spots and surface pitting. No steel cables were observed in other samples of soffit panels.

Table 13 Service Life Modeling Results for Soffit Panels

TI Sample ID	MN Sample ID	Estimated Service Life (Years)			Predicted Current Chloride Concentrations at Reinforcement (%wt of concrete)			Measured Chloride Concentrations at Reinforcement (%wt of concrete)
		D_{28D-L}	D_{28D-H}	$D_{28D-61Y}$	D_{28D-L}	D_{28D-H}	$D_{28D-61Y}$	
1	7N - Deck	9.8	11.2	8.4	0.63	0.71	0.78	0.307
2	17N - Deck	8.8	10.1	7.8	1.11	1.22	1.31	1.286
3	44S - Deck	10.8	12.4	9.1	0.44	0.49	0.52	0.182
4	55S - Deck	10.1	11.5	8.7	0.50	0.55	0.58	0.305
5	72S - East Deck	10.8	11.8	9.7	0.36	0.40	0.43	0.340

5.3.2 Pile Caps – Service Life Modeling Results

The estimated service life for five pile cap elements ranges between 9.0 – 16.7 years, with the predicted chloride concentration ranges between 0.21 – 0.60%. It could be seen that the model over-predicts the chloride concentration for all cap elements (Table 14).

All modelled chloride concentrations exceeded the black-steel corrosion threshold of 0.05% (by weight of normal weight concrete). Measured chloride concentrations at the reinforcement suggest that all five elements have exceeded the black-steel corrosion threshold of 0.05% (by weight of normal weight concrete) except element corresponding to **TI** sample 9.

Table 14 Service Life Modeling Results for Pile Caps

TI Sample ID	MN Sample ID	Estimated Service Life (Years)			Predicted Current Chloride Concentrations at Reinforcement (%wt of concrete)			Measured Chloride Concentrations at Reinforcement (%wt of concrete)
		D _{28D-L}	D _{28D-H}	D _{28D-61Y}	D _{28D-L}	D _{28D-H}	D _{28D-61Y}	
6	7N - Cap	13.7	16.7	10.7	0.23	0.26	0.29	0.066
7	17N - Pile Cap West Side	11.2	13.5	9.0	0.48	0.55	0.60	0.176
8	44S - Cap	11.0	14.1	17.2	0.21	0.24	0.26	0.102
9	55S - Pile Cap	13.6	16.5	10.6	0.24	0.27	0.30	0.024
10	72S - Cap EN. Side of Cap	13.5	16.4	10.6	0.24	0.28	0.30	0.132

5.3.3 Piles – Service Life Modeling Results

As shown in Table 15, the predicted service life of pile elements ranges between 8.2 – 16.9 years, and the estimated chloride concentration at the reinforcement between 0.21 – 0.64%. The model predictions align relatively well with the measured chloride concentrations for **TI** samples 15, 17, and 18. For the other four pile elements, the model over-estimates the chloride build-up at the reinforcement depth. All modelled chloride concentrations exceeded the black-steel corrosion threshold of 0.05% (by weight of normal weight concrete). Except for **TI** sample 11 and 16, the measured chloride concentrations also exceed the corrosion threshold.

By visual observations, embedded steel cables in **TI** samples 11, 16, and 17 revealed scattered corrosion spots, with steel cables in **TI** sample 17 also showed surface pitting. Steel cables in **TI** sample 12 exhibited pervasive surface corrosion. No visible corrosion was detected on steel cables embedded in **TI** sample 13. In **TI** sample 15 and 18, no steel cables were included in the cores.

Table 15 Service Life Modeling Results for Piles

TI Sample ID	MN Sample ID	Estimated Service Life (Years)			Predicted Current Chloride Concentration at Reinforcement (%wt of concrete)			Measured Chloride Concentration at Reinforcement (%wt of concrete)
		D _{28D-L}	D _{28D-H}	D _{28D-61Y}	D _{28D-L}	D _{28D-H}	D _{28D-61Y}	
11	7N - Pile Top North Side	14.2	16.9	9.8	0.21	0.24	0.30	0.039
12	55S - Top Pile	11.8	13.9	8.5	0.40	0.46	0.58	0.142
13	72S - East Pile Tops	12.2	14.1	9.1	0.27	0.30	0.36	0.099
15	17N - 68" Below Pile	12.2	14.5	8.7	0.35	0.41	0.51	0.287
16	44S - Pile 38" from Cap	12.8	15.3	8.8	0.32	0.38	0.48	0.047
17	55S	10.9	12.6	8.5	0.35	0.39	0.46	0.312
18	72S - East	11.1	13.0	8.2	0.46	0.52	0.64	0.594

5.3.4 Comments on Service Life Modeling Results

Based on the results presented in Table 13, 14, and 15, the model over-estimates the chloride buildup significantly at certain elements. This could be attributed to the assumption adopted by the software that diffusion is the dominant mechanism. It is known that many other mechanisms or factors, such as drying or loss of degree of saturation during service, chloride binding by the cementitious paste, and changes of pore structure due to crystallization of salts might have influenced, and in many cases reduced the rate of chloride ingress in concrete. The overestimation noted for soffit panel and pier elements could also be attributed to that the effects of the intermediate repair could have not been accounted for.

It appears that Life-365 provides conservative estimation of chloride ingress for all elements.

6. Conclusions

TI sample 14/ MN sample 7N - Pile Splash South Side was subject to full-depth chloride analysis. The results indicate that at all depths of the core (including sections from pile

and from its encasement), the chloride concentrations (acid-soluble) have exceeded the corrosion initiation threshold of black steel.

Test results of chloride concentrations at reinforcement depths of five core sections extracted from concrete topping of the soffit panels suggest that they have remained below the corrosion threshold of black steel except section from **TI** sample 4/ **MN** sample 55S-Deck.

Service life modeling results for soffit panels, pile caps, and piles (except **TI** sample 14/ **MN** sample 7N) suggest that currently all elements have exceeded their service life, as defined by Life-365, and need major repairs. The modeling results, as could be seen from comparison between predicted and measured chloride concentrations at the depths of reinforcement, reflected the actual conditions of the elements relatively well in certain elements, while over-estimated the chloride ingress in others. Such over-estimation could be due to the software's over-simplified assumption that diffusion is the dominant mechanism and thus incapacity to capture other factors and mechanisms such drying or loss degree of saturation during service, chloride binding to the cementitious paste, and changes of pore structure due to crystallization of salts. The overestimation noted for soffit panel and pier elements could also be attributed to that the effects of the intermediate repair could have not been accounted for.

Limitations

The modeling results of service life presented in this report, although partially based on inputs obtained through direct analysis and petrographic examination of concrete in place, are empirical and limited to the simulation accuracy of Life-365. The corrosion initiation threshold is based on chloride content in concrete. In the opinion of the author, other factors such as pH of the concrete pore solution, the availability of oxygen and of moisture can influence time to corrosion initiation and propagation period. Invasive sampling and evaluation of both concrete and reinforcing steel, if possible, would contribute to characterizing condition of the reinforced concrete elements.

Evaluation of Remaining Service Life of Reinforced Concrete Elements of Ocean Beach Pier, San Diego, California

Attachments:

Attachment A: Sample Log Prepared by Twining Inc. and confirmed by Moffat and Nichol

Attachment B: Report of Petrographic Examination by DRP

Attachment C: Report by Chemistry of Concrete Including Surface Chloride Profiles and Full-Depth Chloride Profile of TI sample 14/MN Sample 7N-Pile Splash South Side

Attachment D: Report by Chemistry of Concrete on Chloride Concentrations at Depths of Reinforcement

Attachment E: Report by Chemistry of Concrete on Apparent Chloride Diffusion Coefficients

Attachment F: Service Life Modeling Results (Graphs) of 17 Elements Modeled Using Life-365



2883 East Spring Street
Suite 300
Long Beach CA 90806
Tel 562.426.3355
Fax 562.426.6424

**Attachment A: Sample Log Prepared by Twining Inc.
and confirmed by Moffat and Nichol**

DRAFT

Twining Project No: 170303.2
 Date of Receiving: April 6th, 2017
 Log Prepared By: Robert Clevenger

M&N Core ID	Sample Location	Structural Element	Total Length (inch)	Presence of Reinforcement (Y/N)	Depth of Reinforcement from Exposure Surface (inch)	Twining Core ID	Comments
7N - Deck	7N	Deck	B=7.2 / T=4.5	No		1	Coating observed
17N - Deck	17N	Deck	B=6.5 / T=5.3	No		2	Coating observed, Bottom Pieces is broken
44S - Deck	44S	Deck	B=7.2 / T=6.0	Yes	1.5" from Bottom of Soffit	3	Coating observed
55S - Deck	55S	Deck	B=8.3 / T=5.0	Yes	1.3" from Bottom of Soffit	4	Coating observed
72S - East Deck	72S	Deck	B=8.0 / T=6.0	No		5	Coating observed
7N - Cap	7N	Cap	I=5.0 / E=4.0	No		6	Broken
17N - Pile Cap West Side	17N	Cap	I=2.0 / E=7.0	No		7	Broken
44S - Cap	44S	Cap	9.0	No		8	
55S - Pile Cap	55S	Cap	8.6	No		9	
72S - Cap East N. Side of Cap	72S	Cap	9.2	Yes	5" from Exterior	10	
7N - Pile Top North Side	7N	Pile Top	7-9	Yes	3.5" from Exterior	11	Coating observed
55S - Top Pile	55S	Pile Top	8.0	Yes	3.0" from Exterior	12	Coating observed
72S - East Pile Tops	72S	Pile Top	9.5	Yes	2.5" from Exterior	13	Coating observed
7N - Pile Splash South Side	7N	Pile Splash Zone	E=3.5 / I=1.5, Enc. = 4	Yes	3" from Interface with Encasement	14	Broken w/ Encasement (4" thick w/ reinforcing 3" from exterior); Coating observed
17N - 68" Below Pile	17N	Pile Splash Zone	9.75	Yes	3.25" from Exterior	15	Coating observed
44S - Pile 38" from Cap	44S	Pile Splash Zone	8.0	Yes	4.0" from Exterior	16	Coating observed
55S	55S	Pile Splash Zone	7	Yes	2.5" from Exterior	17	Coating observed
72S - East	72S	Pile Splash Zone	E=3.0 / I=4.0	Yes	3" from Exterior	18	Broken, Coating observed

Notes:

B=Bottom (Soffit)
 T=Top (Topping)
 E=Exterior (Exposure Surface)
 I=Interior (Side Opposed to Exposure Surface)

Reinforcement in concrete toppings of soffit panels were not documented at receiving, but were documented later on when testing of chloride contents at depths of reinforcement were requested.



2883 East Spring Street
Suite 300
Long Beach CA 90806
Tel 562.426.3355
Fax 562.426.6424

**Attachment B: Report of Petrographic Analysis by
DRP**

DRAFT

Microscopical Examination of Petrographic Thin Sections Prepared from Sections of Concrete Cores Extracted from the Ocean Beach Pier Located in San Diego, California

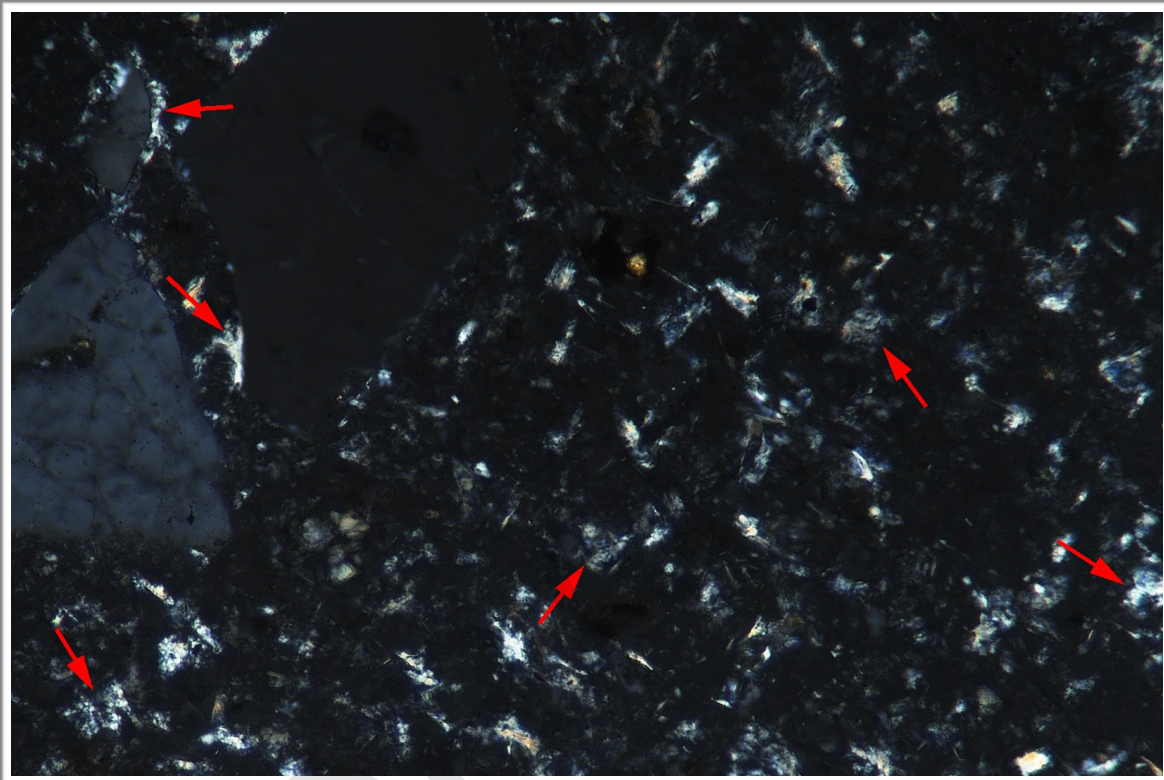

Prepared for

Ms. Yiwen Bu, Ph.D., P.E., LEED AP
Twining, Inc.
San Diego, California

Prepared by

David Rothstein, Ph.D., P.G., FACI
Report No. 177022.d
3 May 2017

1.0 INTRODUCTION

Ms. Yiwen Bu, Ph.D., P.E., LEED AP, Director of Concrete Engineering for Twining, Inc. located in San Diego, California requested DRP, A Twining Company (**DRP**) to perform microscopical examinations of thin sections made from concrete cores that were extracted from the Ocean Beach Pier located in San Diego, California. **DRP** received (3) samples consisting of sawn sections of concrete cores on 18 April 2017. **Table 1** summarizes information regarding the identification and location of the samples. Ms. Bu reported that each section represented the innermost portion of the respective cores. The pier was reportedly constructed in 1966.

Table 1. Summary of Samples

TI Sample	DRP No.	Element	Strength Information
Sample 3	21YD8593	Prestressed lightweight concrete deck	Design strength 5,000 psi @ 28 days
Sample 7	21YD8596	Prestressed pile cap	Design strength 3,250 psi @ 28 days
Sample 16	21YD8595	Precast pile	Design strength 5,000 psi @ 28 days

2.0 SCOPE OF WORK AND PROCEDURES

Ms. Bu requested determinations of the slag content, fly ash content, silica fume content and w/cm for each sample. The testing involved microscopical examination of petrographic thin sections prepared from each core. The samples were photographed in their as-received condition. A thin section was prepared from each sample by first sawing the samples in half. The area for a petrographic thin section was then indicated on a saw cut surface and a billet was cut from the sample. The billets were labeled with the unique **DRP** number assigned to the sample and impregnated with epoxy. The impregnated billets were then fixed to glass slides with epoxy. After the epoxy cured, the slides were trimmed and ground on a Buehler® Petro-Thin device to a thickness of ~ 30 µm (1.2 mil). The slides were then ground to a thickness of ~ 20 µm (0.8 mil) and polished by hand using glass plates and silicon carbide grits in a non-aqueous environment. The thin sections were examined with a Nikon® E-Pol 600 petrographic microscope equipped to provide a 50-1000x magnification range following the standard practice set forth in ASTM C856.

This report summarizes the findings of this scope of work. *Appendices A-C* contain the notes, photographs and micrographs from the examinations.

3.0 FINDINGS

- 3.1 The paste fraction of each sample consists of hydrated portland cement. No fly ash, slag cement or other supplemental cementitious materials were observed.
- 3.2 The degree of hydration is advanced in all three cores, with relict and residual cement grains making up trace amounts (<1 %) to very minor (1-2%) of the paste. The advanced hydration is consistent with the reported age of the construction. In addition, voids in the paste contain deposits of ettringite, which indicates long-term exposure to moisture. This may also contribute to the advanced hydration of the cement.
- 3.3 The estimated w/c for the samples are as follows:
- (a) Sample 3: 0.45-0.55
 - (b) Sample 7: 0.50-0.60
 - (c) Sample 16: 0.45-0.55

These estimations are based on observations of the size, abundance and spacing of relict and residual cement grains in the paste and the size and abundance of calcium hydroxide crystals in the paste. No reference samples of similar age, composition and exposure conditions were available for comparison.

This concludes work performed on this project to date.



David Rothstein, Ph.D., P.G., FACI

Ocean Beach Pier Thin Section Microscopy

Appendices

Appendix A
Appendix B
Appendix C

Sample 3 Microscopy
Sample 7 Microscopy
Sample 16 Microscopy

DRAFT

1. RECEIVED CONDITION	
ORIENTATION	Core section measures 90 mm (3 ½ in.) in diameter and 25 mm (1 in.) long (Figure A1 , Figure A2).
SURFACES	Both ends of the core are saw cut.
GENERAL CONDITION	The concrete is hard and compact and rings lightly when sounded with a hammer.

2. PASTE OBSERVATIONS	
THIN SECTION*	The paste contains hydrated portland cement; no fly ash, slag cement or other SCM were observed (Figure A3). The hydration is very advanced with only traces (< 1%) of RRCG observed; these grains consist of belite with interstitial ferrite and aluminates. CH makes up 6-12% of the paste, is medium grained (mostly 15-25 µm) and evenly distributed.
Estimated w/c	Observations described above are consistent with a w/cm between 0.45-0.50.
<i>* Abbreviations as follows: RRCG = relict and residual cement grains; SCM = supplemental cementitious materials; CH = calcium hydroxide; ITZ = interfacial transition zone. Modal abundances are based on visual estimations.</i>	

FIGURES

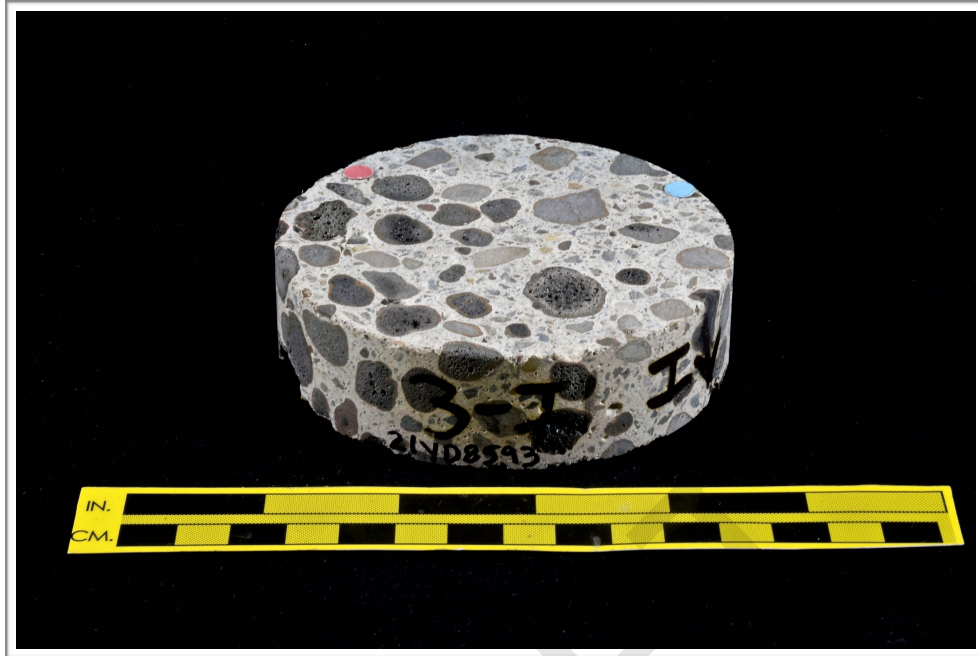

Figure A1. Photograph showing sample. The yellow scale is ~ 150 mm (6 in.) long.

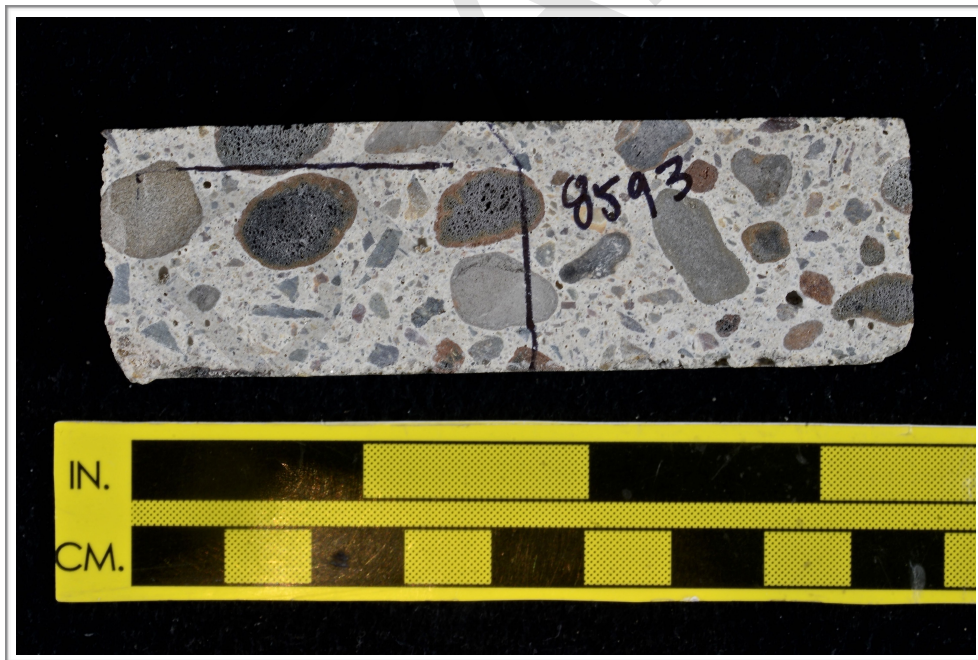

Figure A2. Photograph of the saw cut surface of the sample showing location of thin section.

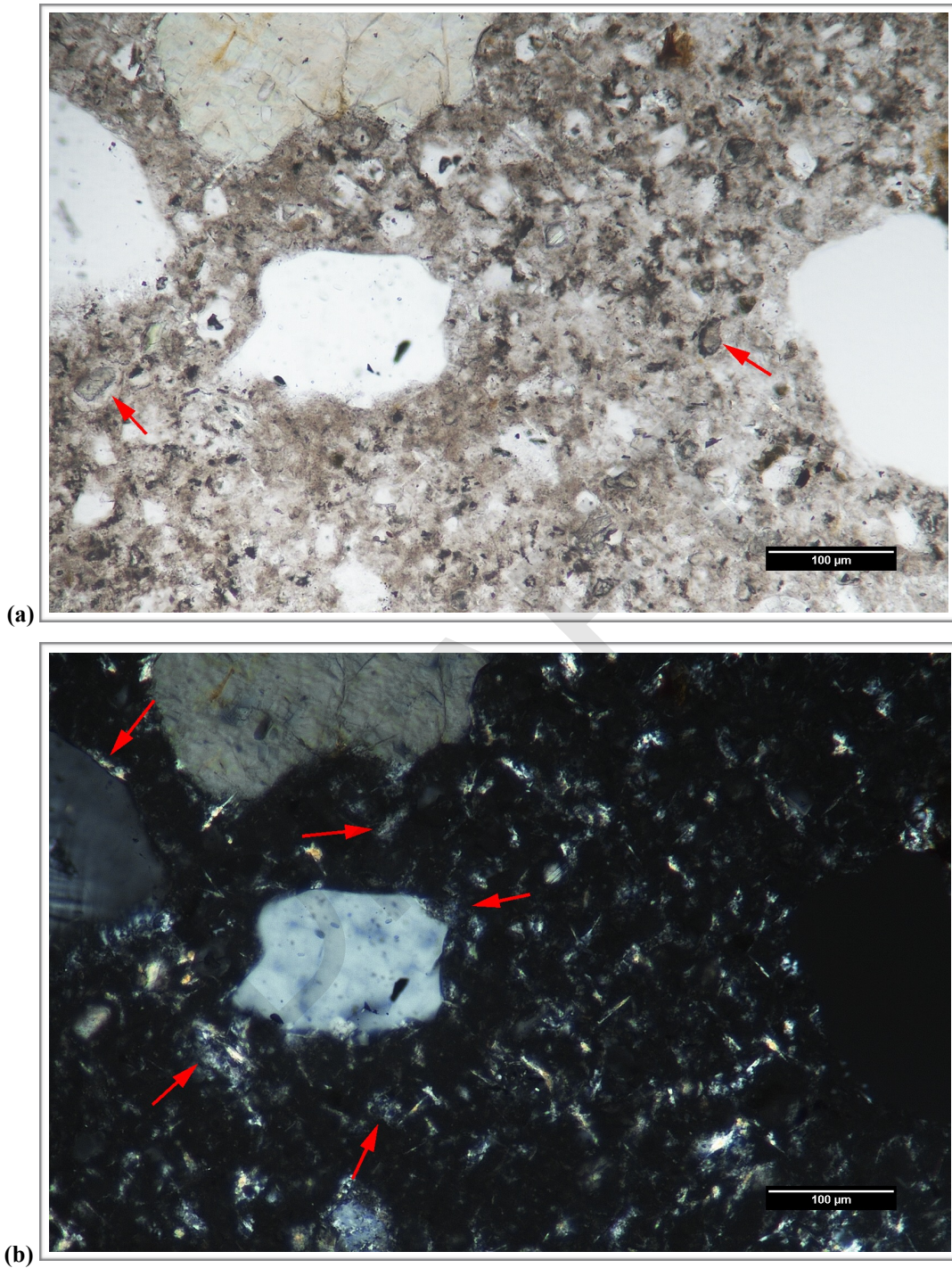

Figure A3. Transmitted light photomicrographs of thin section showing detail of paste in (a) plane-polarized and (b) cross-polarized light. The red arrows indicate RRCG in (a) and CH in (b).

1. RECEIVED CONDITION	
ORIENTATION	Core section measures 90 mm (3 ½ in.) in diameter and 75 mm (3 in.) long (Figure B1 , Figure B2).
SURFACES	Both ends of the core are saw cut.
GENERAL CONDITION	The concrete is hard and compact and rings lightly when sounded with a hammer.

2. PASTE OBSERVATIONS	
THIN SECTION*	The paste contains hydrated portland cement; no fly ash, slag cement or other SCM were observed (Figure B3). The hydration is very advanced with only traces (< 1%) of RRCG observed; these grains consist of belite with interstitial ferrite and aluminates. CH makes up 8-15% of the paste, is medium grained (15-25 µm) with occasional coarse crystals (25-50 µm) observed and is distributed irregularly.
Estimated w/c	Observations described above are consistent with a w/cm between 0.50-0.55.
* Abbreviations as follows: RRCG = relict and residual cement grains; SCM = supplemental cementitious materials; CH = calcium hydroxide; ITZ = interfacial transition zone. Modal abundances are based on visual estimations.	

FIGURES



Figure B1. Photograph showing sample. The yellow scale is ~ 150 mm (6 in.) long.

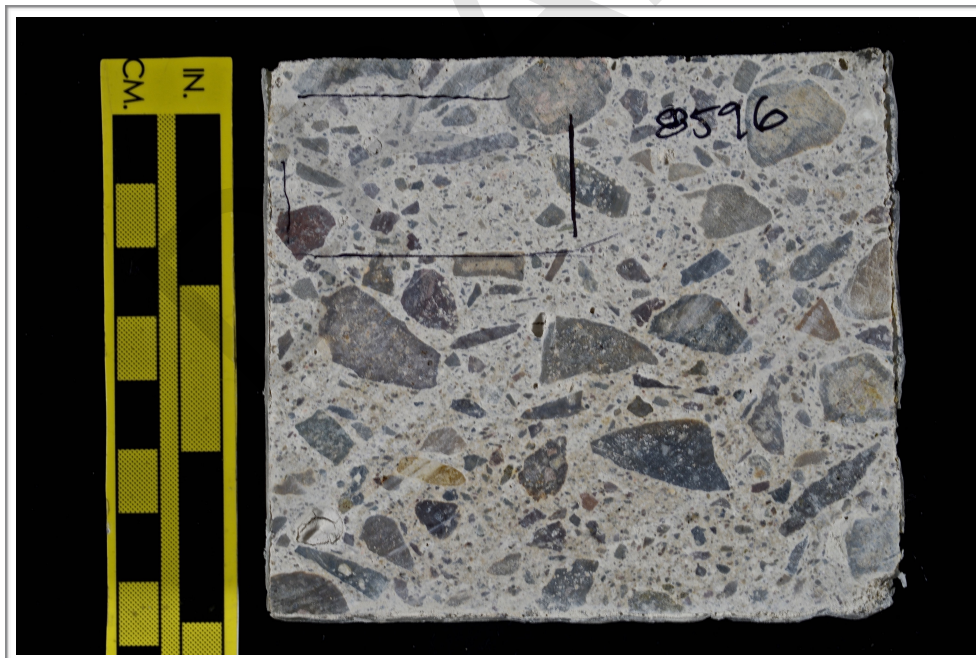

Figure B2. Photograph of the saw cut surface of the sample showing location of thin section.

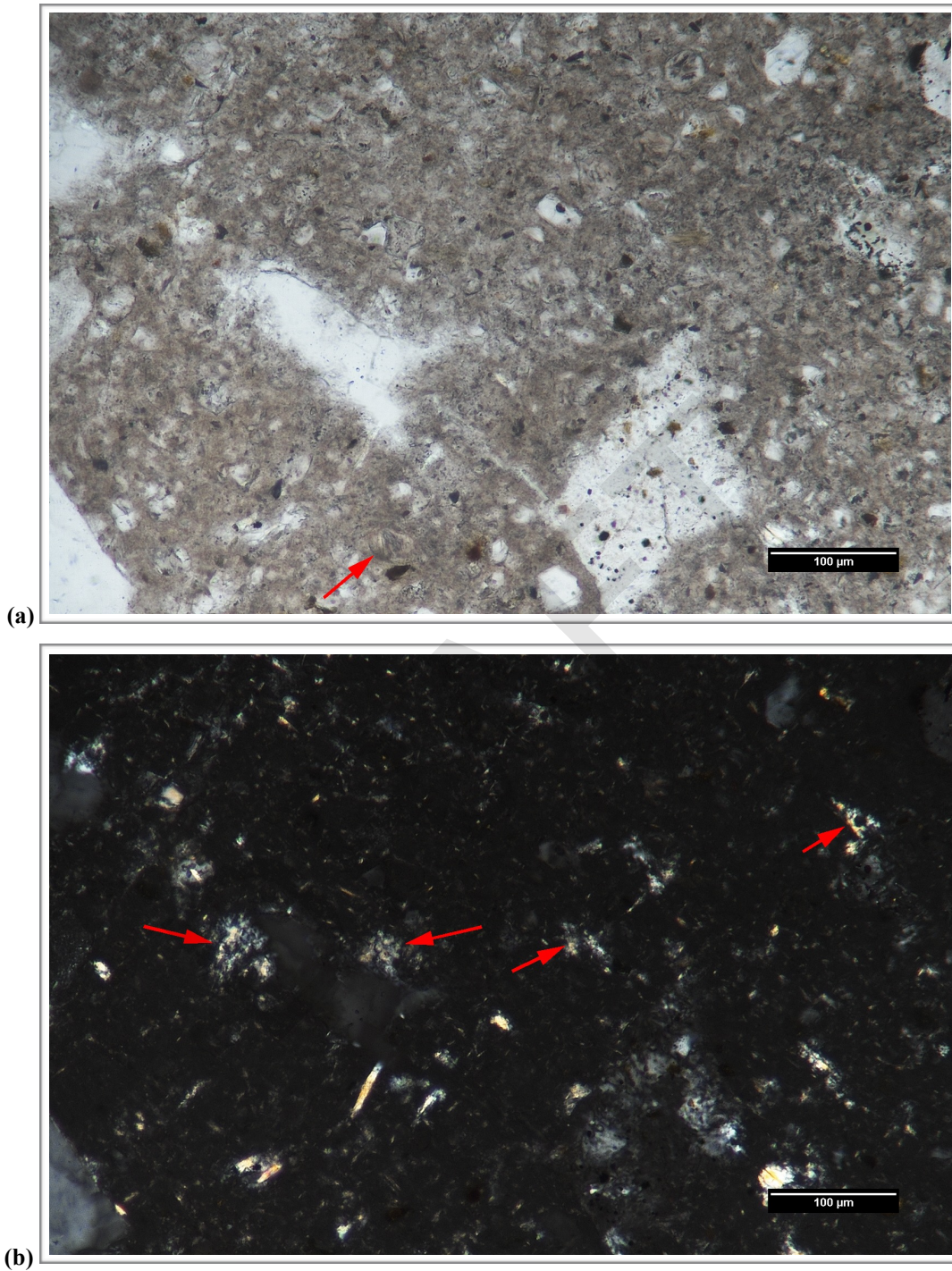

Figure B3. Transmitted light photomicrographs of thin section showing detail of paste in (a) plane-polarized and (b) cross-polarized light. The red arrows indicate RRCG in (a) and CH in (b).

1. RECEIVED CONDITION	
ORIENTATION	Core section measures 90 mm (3 ½ in.) in diameter and 45 mm (1 ¾ in.) long (Figure C1 , Figure C2).
SURFACES	Both ends of the core are saw cut.
GENERAL CONDITION	The concrete is hard and compact and rings lightly when sounded with a hammer.

2. PASTE OBSERVATIONS	
THIN SECTION*	The paste contains hydrated portland cement; no fly ash, slag cement or other SCM were observed (Figure C3). The hydration is advanced with 1-2% RRCG observed; these grains consist of belite with interstitial ferrite and aluminates. CH makes up 8-15% of the paste, is medium grained (15-25 µm) and distributed fairly evenly.
Estimated w/c	Observations described above are consistent with a w/cm between 0.45-0.50.
* Abbreviations as follows: RRCG = relict and residual cement grains; SCM = supplemental cementitious materials; CH = calcium hydroxide; ITZ = interfacial transition zone. Modal abundances are based on visual estimations.	

FIGURES

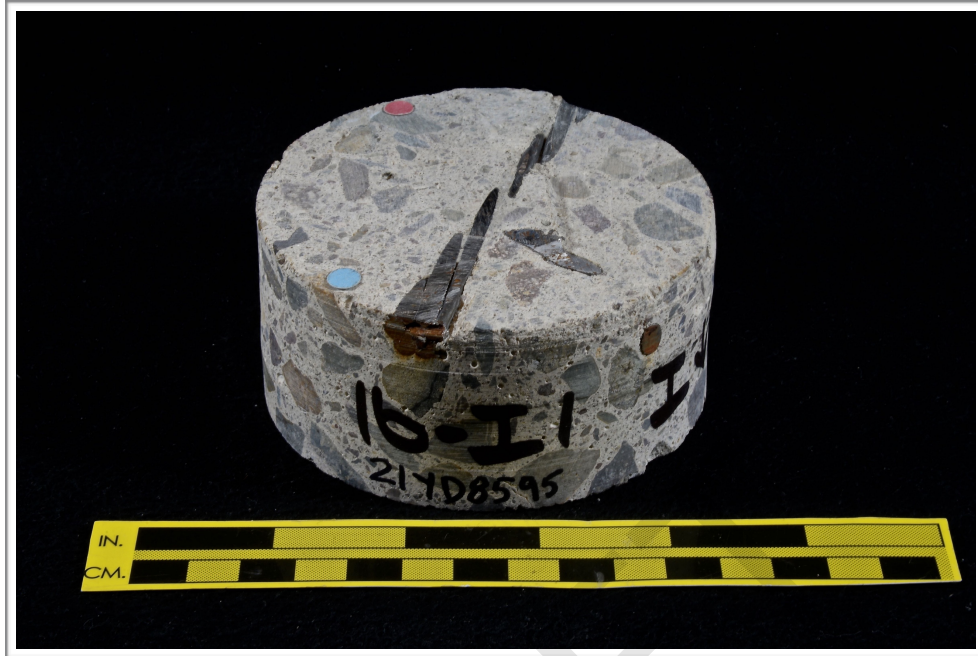

Figure C1. Photograph showing sample. The yellow scale is ~ 150 mm (6 in.) long.

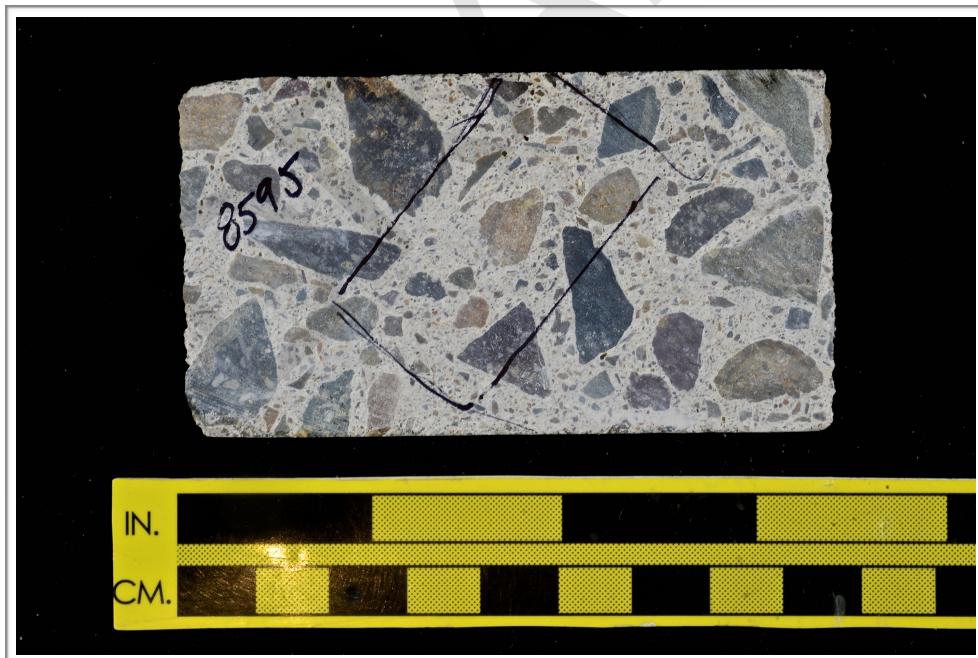

Figure C2. Photograph of the saw cut surface of the sample showing location of thin section.

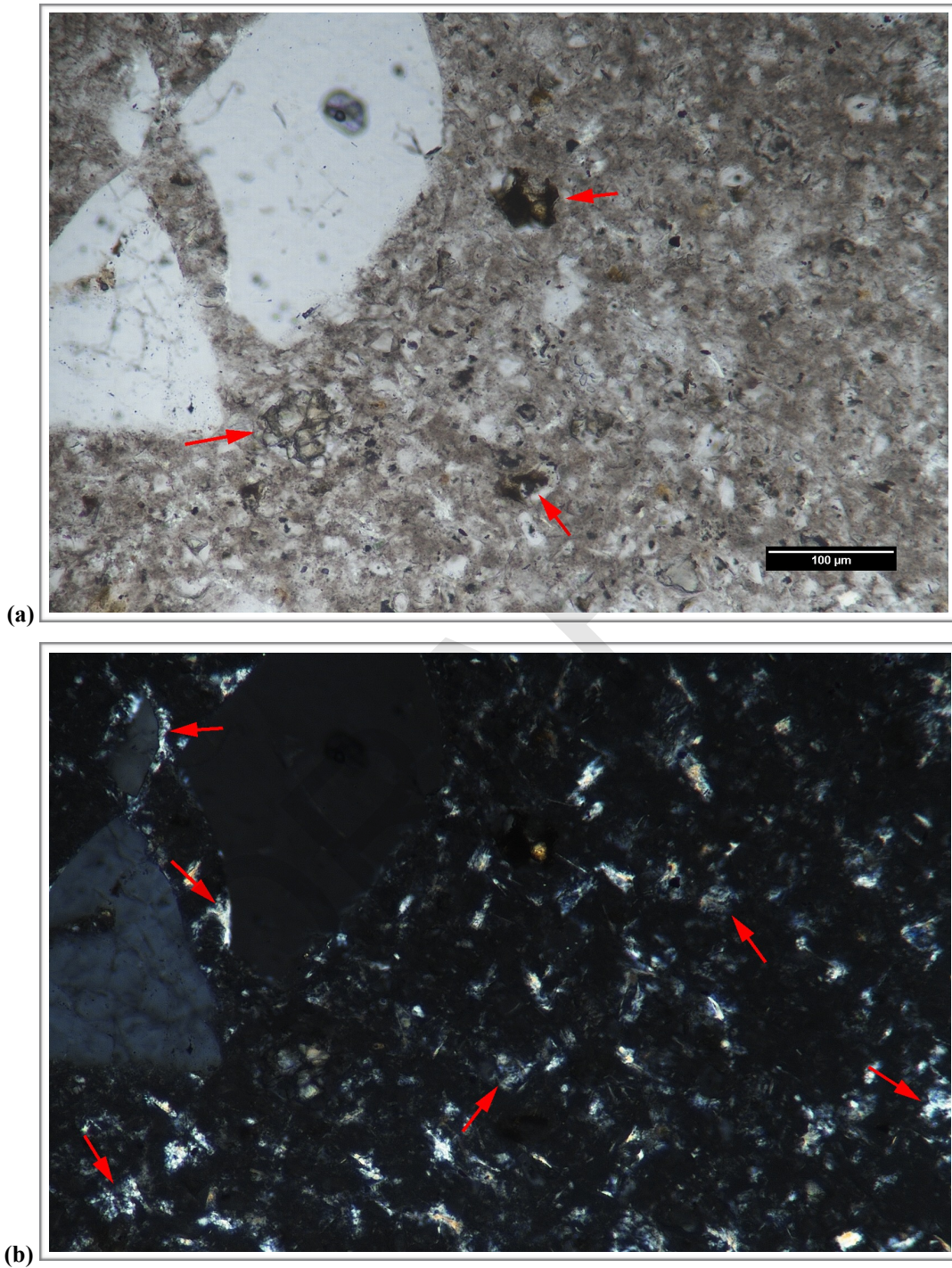

Figure C3. Transmitted light photomicrographs of thin section showing detail of paste in (a) plane-polarized and (b) cross-polarized light. The red arrows indicate RRCG in (a) and CH in (b).



2883 East Spring Street
Suite 300
Long Beach CA 90806
Tel 562.426.3355
Fax 562.426.6424

**Attachment C: Report by Chemistry of Concrete
Including Surface Chloride Profiles and Full-Depth
Chloride Profile of TI sample 14/MN Sample 7N-Pile
Splash South Side**

DRAFT



Yiwen Bu, PE, Ph.D.

May 17, 2017

Twining, Inc.
2883 East Spring Street, Suite 300
Long Beach, CA 90806

Sample Description: Concrete Core Sections

Sample Location: Ocean Beach Pier, San Diego

Job Name: Service Life Evaluation of Ocean Beach Pier

Job No.: 170303.2

TWL Customer: Moffatt and Nichol

Report No.: 00711217d

Analysis Completed:

It was requested to determine the chloride profiles of nineteen (19) concrete cores per ATSM C1556 and C1152. Analytical subsamples were collected by grinding off concrete material in increments from 1mm to 5mm to a depth of 25mm or 35mm, respectively. The profile grinding was used for all cores with the exception of core samples #14. Material from core samples #14 were collected by cutting 0.5" sections through the entire length of the cores (see pictures on pages 19 and 20). The collected material for each layer was homogenized and used for the extraction with dilute nitric acid [HNO₃]. The chloride content was determined using an ion-selective electrode and a Fisher Scientific Accumet pH meter with mV readout. The samples were submitted by Twining and received on April 13, 2017. The as-received core sections are pictured on pages 11 through 22.

The results are listed in Tables 1 through 19 below.

Please let us know if you have any questions regarding these results.

Table 1. Acid soluble chloride profile for sample #1 (7 N – Deck).

Sample #	Sample ID	Collected material, [g]	Analytical subsample, [g]	Titration volume, [ml]	Chloride, [wt%]	Depth, [mm]
1	7 N – Deck	18.2	10.00	38.38	0.654	0 – 1
		30.4	10.00	47.25	0.806	1 – 3
		31.6	10.00	50.63	0.863	3 – 5
		44.1	10.00	54.00	0.921	5 – 8
		51.2	10.00	53.25	0.908	8 – 12
		50.1	10.00	48.88	0.833	12 – 16
		50.6	10.00	43.88	0.748	16 – 20
		63.8	10.00	40.13	0.684	20 – 25

Table 2. Acid soluble chloride profile for sample #2 (17 N - Deck)

Sample #	Sample ID	Collected material, [g]	Analytical subsample, [g]	Titration volume, [ml]	Chloride, [wt%]	Depth, [mm]
2	17 N – Deck	17.0	10.00	91.88	1.567	0 – 1
		28.3	10.00	95.00	1.620	1 – 3
		26.9	10.00	92.63	1.579	3 – 5
		36.5	10.00	89.75	1.530	5 – 8
		49.7	10.00	93.38	1.592	8 – 12
		52.8	10.00	86.50	1.475	12 – 16
		47.2	10.00	96.50	1.646	16 – 20
		19.1	10.00	79.00	1.347	20 – 25

- Fracture surface appeared between 12 and 16mm.

Table 3. Acid soluble chloride profile for sample #3 (44 S – Deck).

Sample #	Sample ID	Collected material, [g]	Analytical subsample, [g]	Titration volume, [ml]	Chloride, [wt%]	Depth, [mm]
3	44 S – Deck	9.4	9.47	28.50	0.513	0 – 1
		27.6	10.00	36.38	0.620	1 – 3
		25.7	10.00	33.63	0.573	3 – 5
		45.8	10.00	32.50	0.554	5 – 8
		53.5	10.00	31.00	0.529	8 – 12
		55.6	10.00	29.25	0.499	12 – 16
		64.8	10.00	20.75	0.354	16 – 20
		84.7	10.00	21.63	0.369	20 – 25

Table 4. Acid soluble chloride profile for sample #4 (55 S – Deck).

Sample #	Sample ID	Collected material, [g]	Analytical subsample, [g]	Titration volume, [ml]	Chloride, [wt%]	Depth, [mm]
4	55 S – Deck	14.8	10.00	44.50	0.759	0 – 1
		28.0	10.00	40.00	0.682	1 – 3
		24.3	10.00	41.00	0.699	3 – 5
		38.3	10.00	35.63	0.608	5 – 8
		49.7	10.00	33.50	0.571	8 – 12
		48.4	10.00	32.50	0.554	12 – 16
		43.5	10.00	31.25	0.533	16 – 20
		62.8	10.00	27.75	0.473	20 – 25

Table 5. Acid soluble chloride profile for sample #5 (72 S - Deck)

Sample #	Sample ID	Collected material, [g]	Analytical subsample, [g]	Titration volume, [ml]	Chloride, [wt%]	Depth, [mm]
5	72 S – Deck	13.4	10.00	41.73	0.712	0 – 1
		34.0	10.00	31.00	0.529	1 – 3
		12.0	10.00	30.38	0.518	3 – 5
		33.9	10.00	32.25	0.550	5 – 8
		43.5	10.00	33.25	0.567	8 – 12
		47.4	10.00	32.50	0.554	12 – 16
		45.3	10.00	30.88	0.527	16 – 20
		54.9	10.00	29.13	0.497	20 – 25

Table 6. Acid soluble chloride profile for sample #6 (7 N - Cap)

Sample #	Sample ID	Collected material, [g]	Analytical subsample, [g]	Titration volume, [ml]	Chloride, [wt%]	Depth, [mm]
6	7 N – Cap	12.7	10.00	13.50	0.230	0 – 1
		61.4	10.00	19.75	0.337	1 – 5
		76.2	10.00	21.88	0.373	5 – 10
		76.4	10.00	19.38	0.330	10 – 15
		73.3	10.00	17.75	0.303	15 – 20
		63.2	10.00	17.00	0.290	20 – 25
		71.5	10.00	13.13	0.224	25 – 30
		72.7	10.00	12.65	0.216	30 – 35

Table 7. Acid soluble chloride profile for sample #7 (17 N - Cap)

Sample #	Sample ID	Collected material, [g]	Analytical subsample, [g]	Titration volume, [ml]	Chloride, [wt%]	Depth, [mm]
7	17 N – Cap	10.3	10.00	47.00	0.801	0 – 1
		64.6	10.00	47.88	0.816	1 – 5
		77.3	10.00	39.63	0.676	5 – 10
		71.9	10.00	34.75	0.593	10 – 15
		77.7	10.00	33.00	0.563	15 – 20
		73.7	10.00	27.38	0.467	20 – 25
		72.9	10.00	27.88	0.475	25 – 30
		77.7	10.00	22.88	0.390	30 – 35

Table 8. Acid soluble chloride profile for sample #8 (44 S - Cap)

Sample #	Sample ID	Collected material, [g]	Analytical subsample, [g]	Titration volume, [ml]	Chloride, [wt%]	Depth, [mm]
8	44 S – Cap	14.2	10.00	11.25	0.192	0 – 1
		55.9	10.00	18.75	0.320	1 – 5
		80.6	10.00	19.25	0.328	5 – 10
		80.8	10.00	17.50	0.298	10 – 15
		82.9	10.00	16.75	0.286	15 – 20
		69.6	10.00	14.75	0.252	20 – 25
		72.7	10.00	12.50	0.213	25 – 30
		72.0	10.00	11.75	0.200	30 – 35

Table 9. Acid soluble chloride profile for sample #9 (55 S - Cap)

Sample #	Sample ID	Collected material, [g]	Analytical subsample, [g]	Titration volume, [ml]	Chloride, [wt%]	Depth, [mm]
9	55 S – Cap	11.8	10.00	30.75	0.524	0 – 1
		58.5	10.00	23.00	0.392	1 – 5
		74.0	10.00	18.75	0.320	5 – 10
		74.7	10.00	15.75	0.269	10 – 15
		75.9	10.00	13.38	0.228	15 – 20
		74.4	10.00	12.13	0.207	20 – 25
		78.8	10.00	9.63	0.164	25 – 30
		73.1	10.00	8.95	0.153	30 – 35

Table 10. Acid soluble chloride profile for sample #10 (72 S - Cap)

Sample #	Sample ID	Collected material, [g]	Analytical subsample, [g]	Titration volume, [ml]	Chloride, [wt%]	Depth, [mm]
10	72 S – Cap	14.2	10.00	14.90	0.254	0 – 1
		60.4	10.00	20.00	0.341	1 – 5
		74.5	10.00	25.13	0.428	5 – 10
		73.2	10.00	23.38	0.399	10 – 15
		75.0	10.00	20.75	0.354	15 – 20
		70.9	10.00	21.38	0.365	20 – 25
		74.5	10.00	19.13	0.326	25 – 30
		66.5	10.00	17.25	0.294	30 – 35

Table 11. Acid soluble chloride profile for sample #11 (7 N – Pile Top)

Sample #	Sample ID	Collected material, [g]	Analytical subsample, [g]	Titration volume, [ml]	Chloride, [wt%]	Depth, [mm]
11	7 N – Pile Top	12.7	10.00	17.38	0.296	0 – 1
		28.8	10.00	18.25	0.311	1 – 3
		46.3	10.00	15.63	0.266	3 – 5
		43.6	10.00	14.63	0.249	5 – 8
		58.1	10.00	12.88	0.220	8 – 12
		60.0	10.00	11.38	0.194	12 – 16
		58.2	10.00	10.50	0.179	16 – 20
		72.3	10.00	10.00	0.171	20 – 25

Table 12. Acid soluble chloride profile for sample #12 (55 S – Pile Top)

Sample #	Sample ID	Collected material, [g]	Analytical subsample, [g]	Titration volume, [ml]	Chloride, [wt%]	Depth, [mm]
12	55 S – Pile Top	12.1	10.00	20.63	0.352	0 – 1
		28.5	10.00	35.00	0.597	1 – 3
		27.4	10.00	31.50	0.537	3 – 5
		42.1	10.00	29.75	0.507	5 – 8
		61.1	10.00	30.75	0.524	8 – 12
		58.9	10.00	30.38	0.518	12 – 16
		58.6	10.00	28.50	0.486	16 – 20
		74.6	10.00	25.00	0.426	20 – 25

Table 13. Acid soluble chloride profile for sample #13 (72 S – Pile Top)

Sample #	Sample ID	Collected material, [g]	Analytical subsample, [g]	Titration volume, [ml]	Chloride, [wt%]	Depth, [mm]
13	72 S – Pile Top	14.6	10.00	24.25	0.414	0 – 1
		30.5	10.00	21.25	0.362	1 – 3
		31.3	10.00	19.75	0.337	3 – 5
		47.9	10.00	18.88	0.322	5 – 8
		59.4	10.00	19.00	0.324	8 – 12
		59.9	10.00	16.38	0.279	12 – 16
		57.0	10.00	15.25	0.260	16 – 20
		69.8	10.00	15.75	0.269	20 – 25

Table 14. Acid soluble chloride profile for sample #14 (7 N – Pile Splash)

Sample #	Sample ID	Collected material, [g]	Analytical subsample, [g]	Titration volume, [ml]	Chloride, [wt%]	Depth, [inch]
14	7 N – Pile Splash	71.6	10.00	31.50	0.537	0 – 0.5
		68.4	10.00	34.38	0.586	0.5 – 1
		84.7	10.00	32.25	0.550	1 – 1.5
		87.3	10.00	32.00	0.546	1.5 – 2
		85.8	10.00	31.00	0.529	2 – 2.5

Table 15. Acid soluble chloride profile for sample #14 (7 N – Pile Splash, Encasement)

Sample #	Sample ID	Collected material, [g]	Analytical subsample, [g]	Titration volume, [ml]	Chloride, [wt%]	Depth, [inch]
14	7 N – Pile Splash Encasement	97.7	10.00	35.13	0.599	0 – 0.5
		102.0	10.00	36.25	0.618	0.5 – 1
		83.1	10.00	20.75	0.354	1 – 1.5
		88.9	10.00	10.13	0.173	1.5 – 2
		81.8	10.00	7.13	0.122	2 – 2.5
		76.1	10.00	13.00	0.222	2.5 – 3
		87.9	10.00	16.75	0.286	3 – 3.5
		81.2	10.00	23.50	0.401	3.5 – 4

Table 16. Acid soluble chloride profile for sample #15 (17 N – Pile Splash)

Sample #	Sample ID	Collected material, [g]	Analytical subsample, [g]	Titration volume, [ml]	Chloride, [wt%]	Depth, [mm]
15	17 N – Pile Splash	11.1	10.00	27.00	0.460	0 – 1
		30.4	10.00	29.63	0.505	1 – 3
		30.5	10.00	29.25	0.499	3 – 5
		47.8	10.00	27.63	0.471	5 – 8
		63.0	10.00	26.75	0.456	8 – 12
		58.4	10.00	24.63	0.420	12 – 16
		57.8	10.00	23.50	0.401	16 – 20
		73.7	10.00	24.25	0.414	20 – 25

Table 17. Acid soluble chloride profile for sample #16 (44 S – Pile Splash)

Sample #	Sample ID	Collected material, [g]	Analytical subsample, [g]	Titration volume, [ml]	Chloride, [wt%]	Depth, [mm]
16	44 S – Pile Splash	12.1	10.00	26.10	0.445	0 – 1
		31.2	10.00	26.75	0.456	1 – 3
		32.5	10.00	26.38	0.450	3 – 5
		50.1	10.00	26.75	0.456	5 – 8
		59.1	10.00	26.25	0.448	8 – 12
		59.5	10.00	25.38	0.433	12 – 16
		62.6	10.00	21.88	0.373	16 – 20
		70.8	10.00	21.25	0.362	20 – 25

Table 18. Acid soluble chloride profile for sample #17 (55 S – Pile Splash)

Sample #	Sample ID	Collected material, [g]	Analytical subsample, [g]	Titration volume, [ml]	Chloride, [wt%]	Depth, [mm]
17	55 S – Pile Splash	17.5	10.00	27.38	0.467	0 – 1
		32.1	10.00	26.75	0.456	1 – 3
		28.6	10.00	25.88	0.441	3 – 5
		52.9	10.00	25.63	0.437	5 – 8
		57.4	10.00	24.38	0.416	8 – 12
		54.5	10.00	21.63	0.369	12 – 16
		58.8	10.00	22.38	0.382	16 – 20
		72.2	10.00	21.38	0.365	20 – 25

Table 19. Acid soluble chloride profile for sample #18 (72 S – Pile Splash)

Sample #	Sample ID	Collected material, [g]	Analytical subsample, [g]	Titration volume, [ml]	Chloride, [wt%]	Depth, [mm]
18	72 S – Pile Splash	13.0	10.00	38.63	0.659	0 – 1
		30.4	10.00	39.25	0.669	1 – 3
		27.4	10.00	40.63	0.693	3 – 5
		46.3	10.00	37.63	0.642	5 – 8
		53.4	10.00	37.75	0.644	8 – 12
		59.0	10.00	43.75	0.746	12 – 16
		60.4	10.00	47.25	0.806	16 – 20
		72.4	10.00	43.13	0.735	20 – 25

- Chloride content is reported by weight of oven dry concrete
- Analytical subsamples were collected from the exterior facing surfaces
- Exterior facing surface was indicated by 'E'.



Core #1: As-received profile section mounted on Al base plate

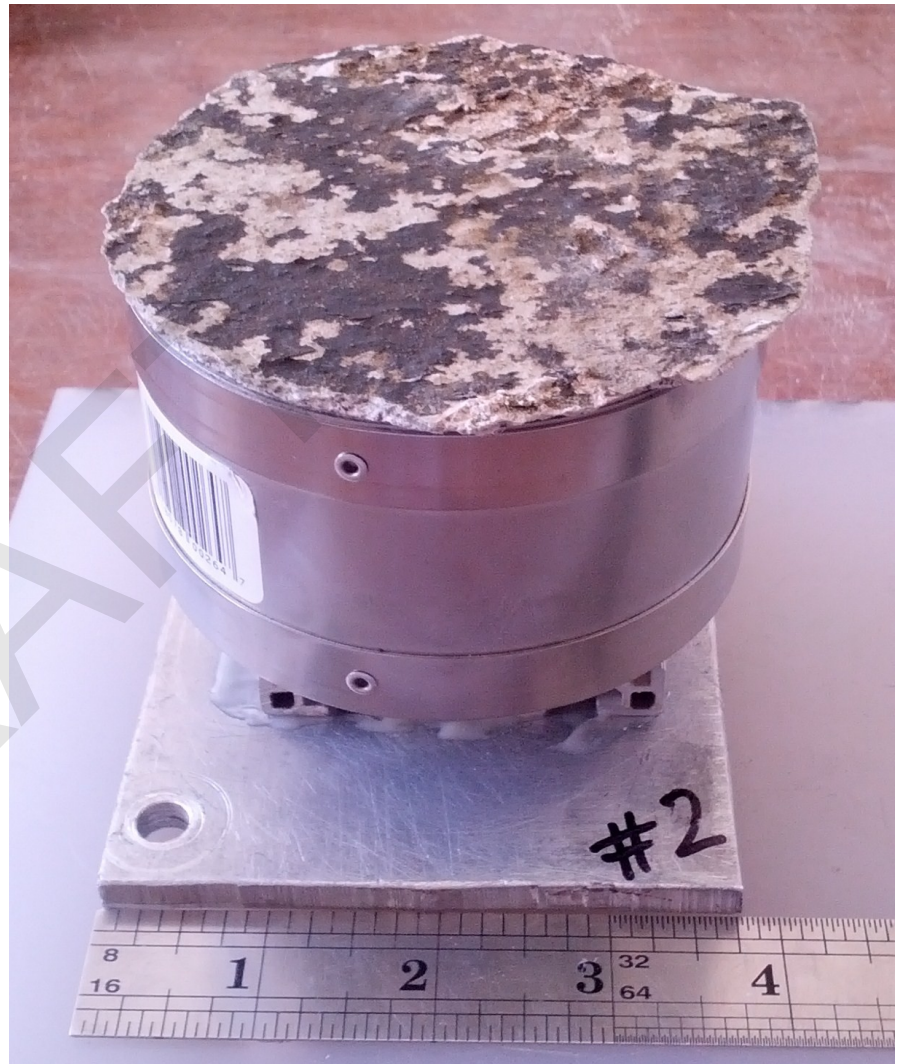

Core #2: The profile section was fractured and the two pieces were fixated with a 4" sheet metal collar.



Core #3: As-received profile section mounted on Al base plate



Core #4: As-received profile section mounted on Al base plate

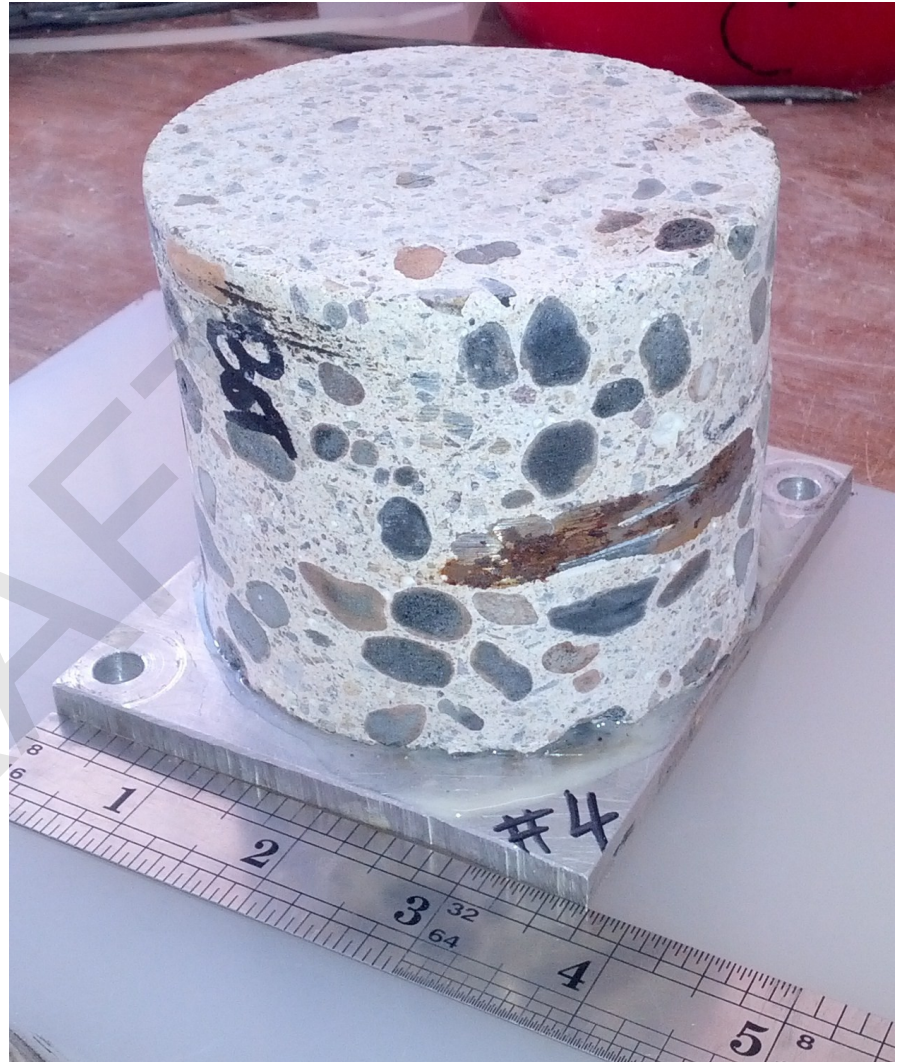

Core #4: As-received profile section mounted on Al base plate showing part of the embedded steel cable



Core #5: As-received profile section mounted on Al base plate



Core #6: As-received profile section mounted on Al base plate



Core #7: As-received profile section mounted on Al base plate



Core #8: As-received profile section mounted on Al base plate



Core #9: As-received profile section mounted on Al base plate

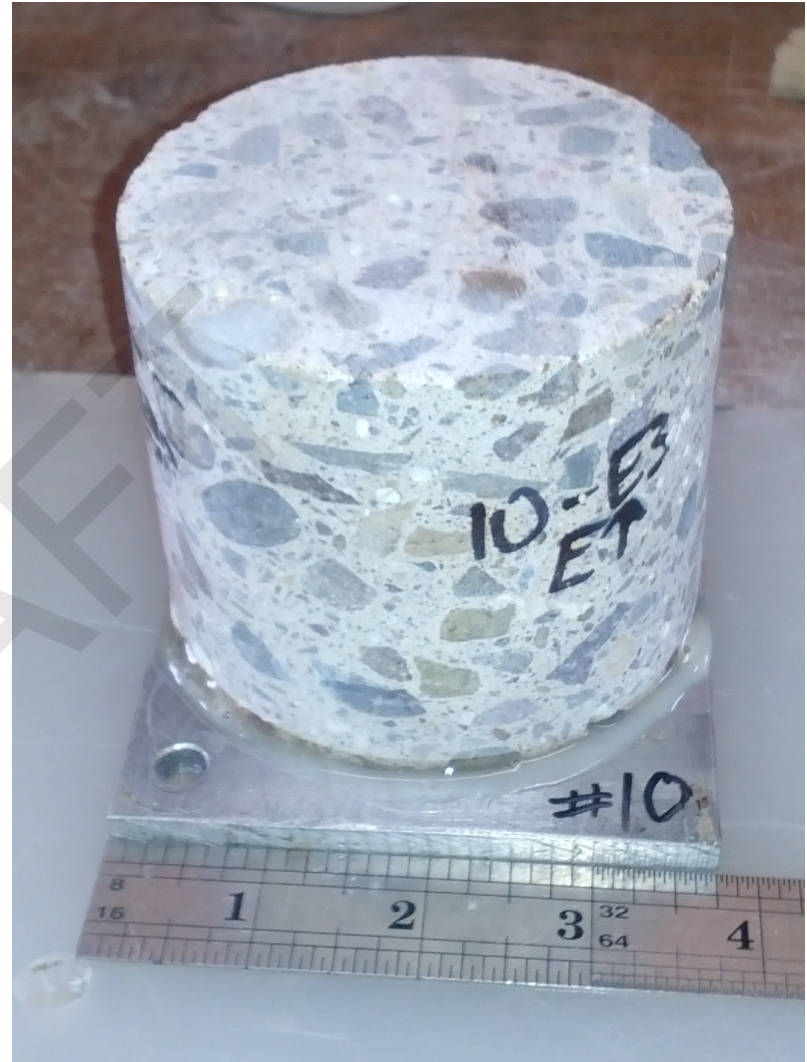

Core #10: As-received profile section mounted on Al base plate



Core #11: As-received profile section mounted on Al base plate



Core #12: As-received profile section mounted on Al base plate



Core #13: As-received profile section mounted on Al base plate

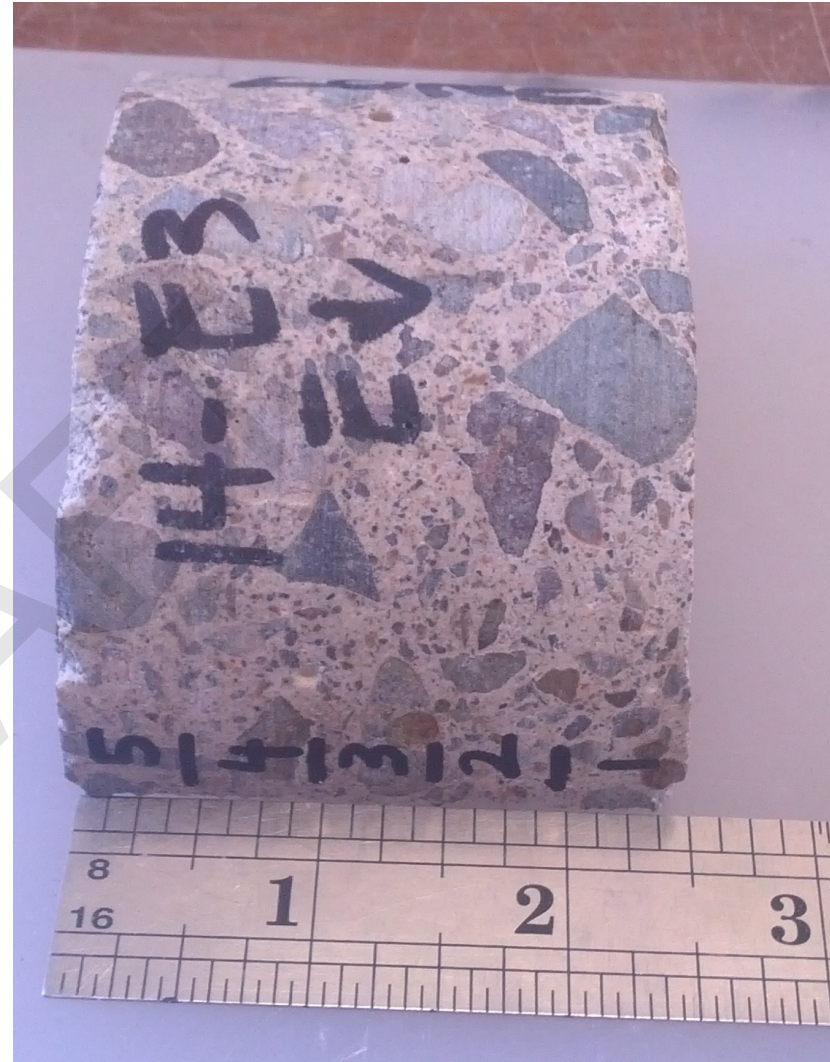

Core #14: Half core A (Pile Splash) with marked 0.5" sections. Sections were cut on a tile saw with a 1/16" blade.



Core #14: Half core A (Pile Splash, Encasement) with embedded steel cable visible between sections 6 and 7. The 0.5” sections were cut on a tile saw with a 1/16” blade.



Core #14: Half core B (Pile Splash, Encasement) with embedded steel cable visible between sections 6 and 7. Half core B was not sectioned.



Core #15: As-received profile section mounted on Al base plate



Core #16: As-received profile section mounted on Al base plate



Core #17: As-received profile section mounted on Al base plate showing the embedded steel cable.



Core #18: As-received profile section mounted on Al base plate



2883 East Spring Street
Suite 300
Long Beach CA 90806
Tel 562.426.3355
Fax 562.426.6424

**Attachment D: Report by Chemistry of Concrete on
Chloride Concentrations at Depths of Reinforcement**

DRAFT

**Yiwen Bu, PE, Ph.D.**

June 20, 2017

Twining, Inc.
2883 East Spring Street, Suite 300
Long Beach, CA 90806

Sample Description: Concrete Core Sections**Sample Location:** Ocean Beach Pier, San Diego**Job Name:** Service Life Evaluation of Ocean Beach Pier**Job No.:** 170303.2**TWL Customer:** Moffatt and Nichol**Report No.:** 00711817c**Analysis Completed:** June 14, 2017

It was requested to determine the chloride-ion content of seventeen (17) concrete cores per ATSM C1152. Each core extracted from deck elements consists of a soffit section (samples 1 through 5) and a topping section (samples 1T through 5T). Concrete sections (3/4" thick) were cut at either the observed reinforcement level or the provided design depth and broken up with a jaw crusher. The coarse material (>0.85mm) was ground in a disk pulverizer, recombined with the fine material and homogenized. Analytical subsamples of about 10g were selected using a mechanical sample splitter and used for the extraction with dilute nitric acid [HNO₃]. The chloride content was determined using an ion-selective electrode and a Fisher Scientific Accumet pH meter with mV readout. The cores were submitted by Twining and received on April 13, 2017.

The total number of core sections tested was twenty two (22) and the results are listed in Table 1 below. Visual observations of the recovered reinforcement elements are listed in Table 2. Photos of the concrete cores and recovered steel elements are shown on pages 4 through 17.

Please let us know if you have any questions regarding these results.

Table 1. Acid soluble chloride content by weight of oven dry concrete

Sample #	Sample ID	Cut section, [g]	Analytical subsample, [g]	Titration volume, [ml]	Chloride, [wt%]	Location	Reinforcement level, [inch]
1	7 N – Deck (soffit)	209.9	11.93	21.08	0.307	design	1 3/4
1T	7 N – Deck (topping)	309.9	10.49	1.45	0.024	design	1 1/2
2	17 N – Deck (soffit)	150.5	9.99	73.95	1.286	design	1 3/4
2T	17 N – Deck (topping)	289.8	11.84	2.35	0.035	design	1 1/2
3	44 S – Deck (soffit)	221.4	10.41	10.88	0.182	design	1 3/4
3T	44 S – Deck (topping)	262.9	10.07	3.83	0.029	observed	2 7/8
4	55 S – Deck (soffit)	267.9	10.66	18.70	0.305	observed	1 5/8
4T	55 S – Deck (topping)	303.8	10.14	3.45	0.059	observed	1 3/4
5	72 S – Deck (soffit)	244.1	11.28	22.08	0.340	design	1 3/4
5T	72 S – Deck (topping)	272.5	10.74	0.75	0.012	design	1 1/2
6	7 N – Cap	244.1	10.40	3.95	0.066	design	2 1/2
7	17 N – Cap	263.0	11.17	11.33	0.176	design	2 1/2
8	44 S – Cap	279.4	11.44	6.70	0.102	design	2 1/2
9	55 S – Cap	288.8	11.48	1.58	0.024	design	2 1/2
10	72 S – Cap	249.0	10.34	7.83	0.132	design	2 1/2
11	7 N – Pile Top	267.4	10.85	2.45	0.039	observed	2 1/4
12	55 S – Pile Top	247.2	11.53	9.45	0.142	observed	2 1/4
13	72 S – Pile Top	275.4	11.12	6.33	0.099	observed	1 7/8
15	17 N – Pile Splash	203.4	11.46	18.95	0.287	observed	2 1/4
16	44 S – Pile Splash	279.8	11.93	3.20	0.047	observed	2 3/8
17	55 S – Pile Splash	317.3	9.45	16.95	0.312	observed	1 3/4
18	72 S – Pile Splash	158.9	9.75	33.33	0.594	observed	2 1/8

Table 2. Visual observations of recovered reinforcement elements

Sample #	Sample ID	Visual observation of embedded reinforcement elements
3T	44 S – Deck (topping)	Steel rebar, scattered corrosion spots near core surface
4	55 S – Deck (soffit)	Steel cable, scattered corrosion spots, surface pitting
4T	55 S – Deck (topping)	Steel rebar, no visible signs of corrosion on the embedded portion of the rebar
11	7 N – Pile Top	Steel cable, scattered corrosion spots
12	55 S – Pile Top	Steel cable, pervasive surface corrosion
13	72 S – Pile Top	Steel cable, no corrosion was observed
16	44 S – Pile Splash	Steel cable, scattered corrosion spots
17	55 S – Pile Splash	Steel cable, scattered corrosion spots, surface pitting



Core #1: Section for chloride analysis was cut at 1 3/4" from the exposure surface (bottom). No reinforcement was observed.



Core #1T: Section for chloride analysis was cut at 1 1/2" from the bottom surface. No reinforcement was observed.

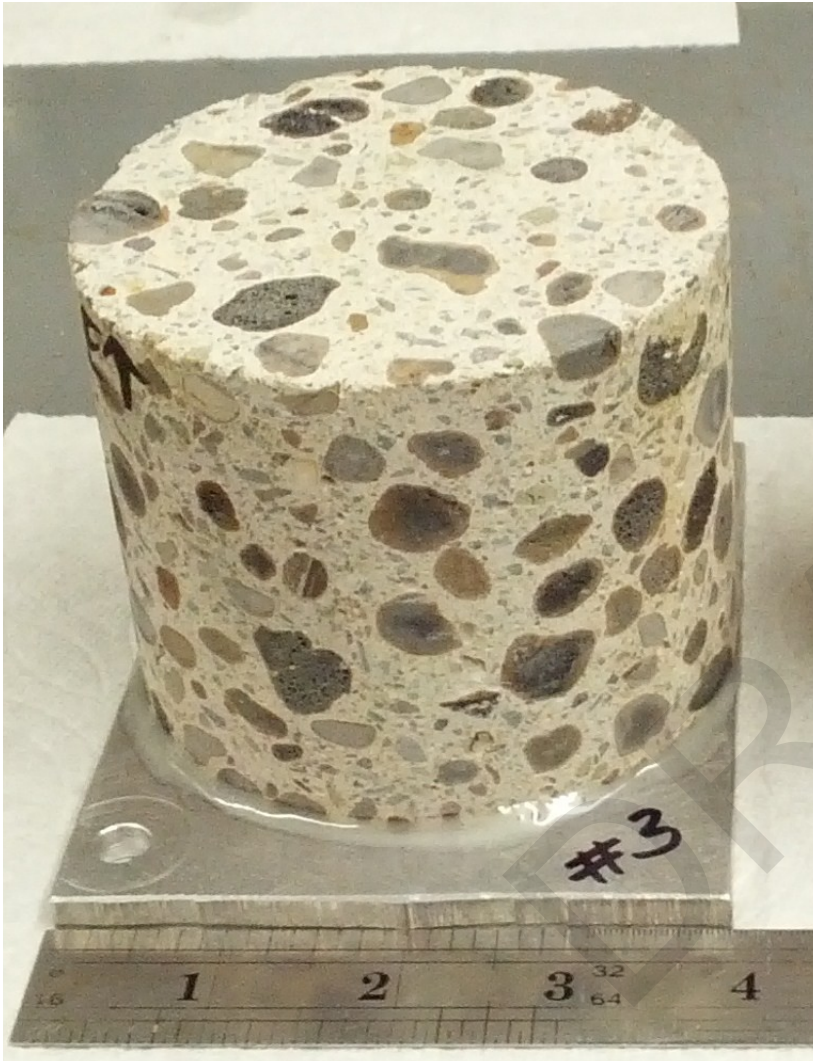

Core #3: Section for chloride analysis was cut at 1 3/4" from the exposure surface (bottom). No reinforcement was observed.

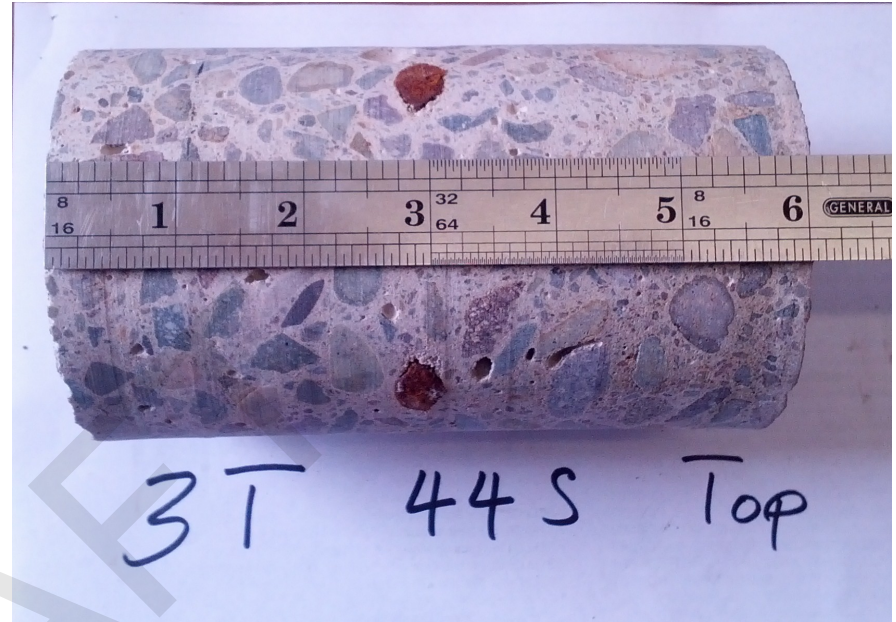

Core #3T: Section for chloride analysis was cut at the observed reinforcement level. Reinforcement is located at about 2 7/8" measured from the bottom surface (left hand side).



Core #4: Section for chloride analysis was cut at the observed reinforcement level. Reinforcement is located at about 1 5/8" below the exposure surface (bottom)



Core #4T: Section for chloride analysis was cut at the observed reinforcement level. Reinforcement is located at about 1 3/4" measured from the bottom surface (left hand side).



Core #5: Section for chloride analysis was cut at 1 3/4" from the exposure surface (bottom). No reinforcement was observed.



Core #5T: Section for chloride analysis was cut at 1 1/2" from the bottom surface. No reinforcement was observed.

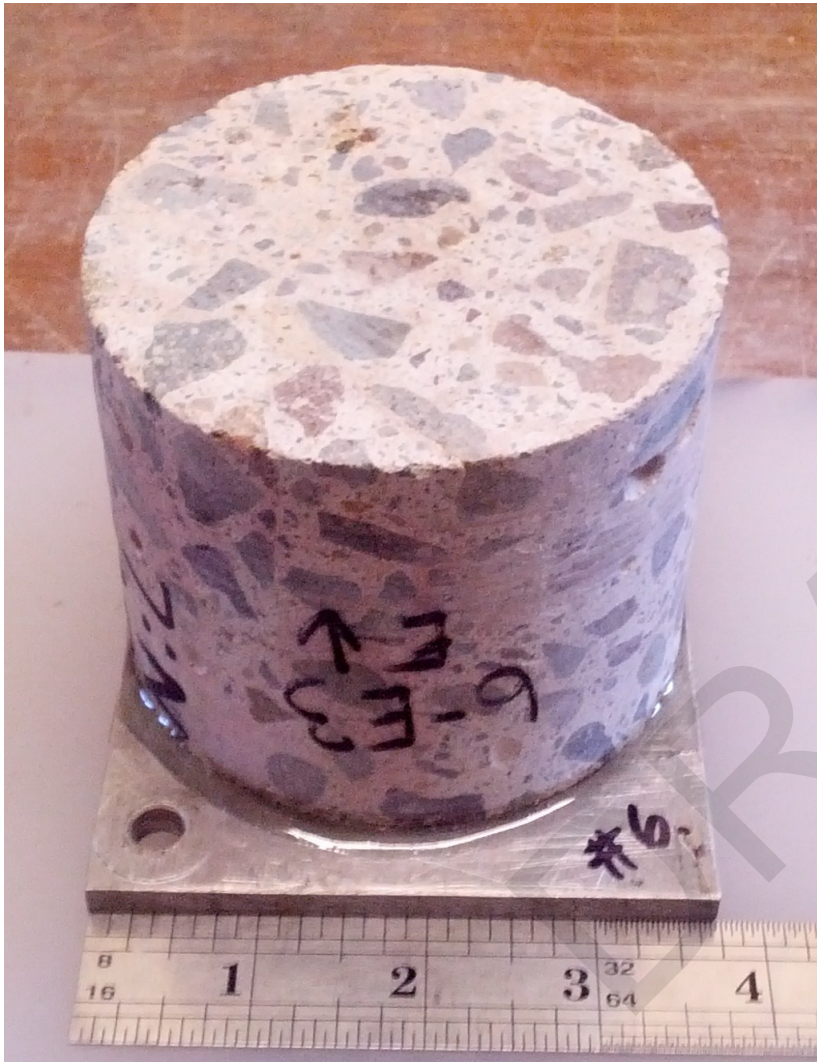

Core #6: Section for chloride analysis was cut at 2 1/2" from the exposure surface. No reinforcement was observed.



Core #7: Section for chloride analysis was cut at 2 1/2" from the exposure surface. No reinforcement was observed.



Core #8: Section for chloride analysis was cut at 2 1/2" from the exposure surface. No reinforcement was observed.



Core #9: Section for chloride analysis was cut at 2 1/2" from the exposure surface. No reinforcement was observed.



Core #10: Section for chloride analysis was cut at 2 1/2" from the exposure surface. No reinforcement was observed.



Core #11: Section for chloride analysis was cut at the observed reinforcement level. Reinforcement is located at about 2 1/4" below the exposure surface.



Core #12: Section for chloride analysis was cut at the observed reinforcement level. Reinforcement is located at about 2 1/4" below the exposure surface



Core #13: Section for chloride analysis was cut at the observed reinforcement level. Reinforcement is located at about 1 7/8" below the exposure surface.



Core #15: Section for chloride analysis was cut at the observed reinforcement level. Reinforcement is located at about 2 1/4" below the exposure surface.



Core #16: Section for chloride analysis was cut at the observed reinforcement level. Reinforcement is located at about 2 3/8" below the exposure surface.



Core #17: Section for chloride analysis was cut at the observed reinforcement level. Reinforcement is located at about $1 \frac{3}{4}$ " below the exposure surface.



Core #18: Section for chloride analysis was cut at the observed reinforcement level. Reinforcement is located at about $2 \frac{1}{8}$ " below the exposure surface.

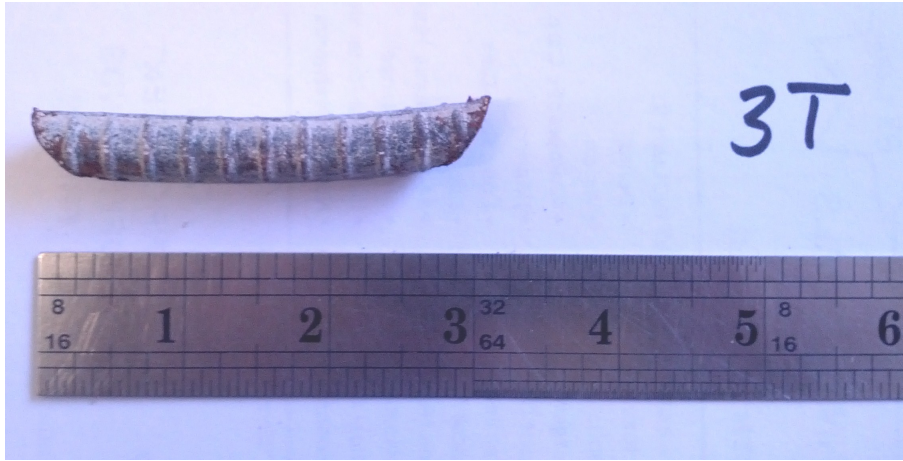

Recovered reinforcement element (steel rebar) of core #3T



Recovered reinforcement elements (steel cable) of core #4



Recovered reinforcement element (steel rebar) of core #4T



Recovered reinforcement elements (steel cable) of core #11



Recovered reinforcement elements (steel cable) of core #12



Recovered reinforcement elements (steel cable) of core #13



Recovered reinforcement elements (steel cable) of core #16



Recovered reinforcement elements (steel cable) of core #17

DRAFT



2883 East Spring Street
Suite 300
Long Beach CA 90806
Tel 562.426.3355
Fax 562.426.6424

**Attachment E: Report by Chemistry of Concrete on
Apparent Chloride Diffusion Coefficients**

DRAFT



Yiwen Bu, PE, Ph.D.

June 1, 2017

Twining, Inc.
2883 East Spring Street, Suite 300
Long Beach, CA 90806

Sample Description: Concrete Core Sections

Sample Location: Ocean Beach Pier, San Diego

Job Name: Service Life Evaluation of Ocean Beach Pier

Job No.: 170303.2

TWL Customer: Moffatt and Nichol

Report No.: 00711617

Analysis Completed: May 31, 2017

It was requested to determine the chloride profiles and apparent chloride diffusion coefficient of six (6) concrete cores per ATSM C1556 and C1152. Analytical subsamples were collected by grinding off concrete material in increments from 1mm to 5mm to a depth of 30mm or 35mm, respectively. The collected material for each layer was homogenized and used for the extraction with dilute nitric acid [HNO₃]. The chloride content was determined using an ion-selective electrode and a Fisher Scientific Accumet pH meter with mV readout.

The apparent diffusion coefficient and projected chloride ion concentration were calculated using a non-linear least squares regression analysis (see graphs on pages 7 through 9). The chloride content from the exposure surface (1st data point) was omitted from the regression analysis.

The cores were conditioned by Twining according to ASTM C1556 and submitted for testing after exposure to a sodium chloride solution (165 ± 1 g/l) for 35 days. The cores were received on May 20, 2017 and are pictured on pages 10 through 12.

The results are listed in Tables 1 through 7 below.



Please let us know if you have any questions regarding these results.

DRAFT

Table 1. Acid soluble chloride profile for exposure sample #1 (7 N – Deck).

Sample #	Sample ID	Collected material, [g]	Analytical subsample, [g]	Titration volume, [ml]	Chloride, [mass %]	Depth, [mm]
1	7 N – Deck	9.3	9.21	66.95	1.240	0 – 1
		18.1	10.00	63.33	1.080	1 – 3
		23.8	10.00	47.83	0.816	3 – 6
		33.7	10.00	27.58	0.470	6 – 10
		40.7	10.00	13.45	0.229	10 – 15
		39.7	10.00	6.83	0.116	15 – 20
		40.3	10.00	4.20	0.072	20 – 25
		42.4	10.00	3.33	0.057	25 – 30

Table 2. Acid soluble chloride profile for exposure sample #5 (72 S - Deck)

Sample #	Sample ID	Collected material, [g]	Analytical subsample, [g]	Titration volume, [ml]	Chloride, [mass %]	Depth, [mm]
5	72 S – Deck	8.7	8.66	67.83	1.336	0 – 1
		15.8	10.00	62.08	1.059	1 – 3
		23.1	10.00	45.20	0.771	3 – 6
		30.4	10.00	26.95	0.460	6 – 10
		39.6	10.00	14.08	0.240	10 – 15
		37.8	10.00	6.20	0.106	15 – 20
		39.4	10.00	2.58	0.044	20 – 25
		40.6	10.00	1.70	0.029	25 – 30

Table 3. Acid soluble chloride profile for exposure sample #8 (44 S – Cap).

Sample #	Sample ID	Collected material, [g]	Analytical subsample, [g]	Titration volume, [ml]	Chloride, [mass %]	Depth, [mm]
8	44 S – Cap	10.2	9.86	70.55	1.268	0 – 1
		38.8	10.00	35.58	0.631	1 – 5
		50.0	10.00	16.95	0.300	5 – 10
		49.4	10.00	7.70	0.137	10 – 15
		50.2	10.00	2.70	0.048	15 – 20
		49.2	10.00	0.85	0.015	20 – 25
		51.9	10.00	0.35	0.006	25 – 30
		47.4	10.00	0.45	0.008	30 – 35

Table 4. Acid soluble chloride profile for exposure sample #10 (72 S – Cap).

Sample #	Sample ID	Collected material, [g]	Analytical subsample, [g]	Titration volume, [ml]	Chloride, [mass %]	Depth, [mm]
10	72 S – Cap	9.9	9.95	59.58	1.021	0 – 1
		37.5	10.00	45.83	0.781	1 – 5
		46.0	10.00	30.58	0.521	5 – 10
		48.1	10.00	19.33	0.330	10 – 15
		45.9	10.00	13.20	0.225	15 – 20
		48.3	10.00	8.33	0.142	20 – 25
		48.3	10.00	6.58	0.112	25 – 30
		49.6	10.00	3.95	0.067	30 – 35

Table 5. Acid soluble chloride profile for exposure sample #11 (7 N – Pile Top)

Sample #	Sample ID	Collected material, [g]	Analytical subsample, [g]	Titration volume, [ml]	Chloride, [mass %]	Depth, [mm]
11	7 N – Pile Top	14.3	10.00	43.45	0.741	0 – 1
		21.8	10.00	37.70	0.643	1 – 3
		29.5	10.00	36.20	0.617	3 – 6
		40.9	10.00	28.95	0.494	6 – 10
		47.3	10.00	20.08	0.342	10 – 15
		53.5	10.00	13.45	0.229	15 – 20
		51.2	10.00	7.83	0.133	20 – 25
		51.7	10.00	4.45	0.076	25 – 30

Table 6. Acid soluble chloride profile for exposure sample #13 (72 S – Pile Top)

Sample #	Sample ID	Collected material, [g]	Analytical subsample, [g]	Titration volume, [ml]	Chloride, [mass %]	Depth, [mm]
13	72 S – Pile Top	13.9	10.00	48.95	0.835	0 – 1
		20.8	10.00	42.70	0.728	1 – 3
		28.4	10.00	33.20	0.566	3 – 6
		40.9	10.00	23.45	0.400	6 – 10
		49.6	10.00	15.70	0.268	10 – 15
		50.4	10.00	8.58	0.146	15 – 20
		49.6	10.00	3.95	0.067	20 – 25
		51.2	10.00	1.95	0.033	25 – 30

- Chloride content is based on the as-received weight.

Table 7. Results of the non-linear least squares regression analysis for the projected chloride content and diffusion coefficient.

Sample #	Sample ID	Initial chloride content C_i, %	Projected chloride content C_s, %	Apparent chloride diffusion coefficient D_a, m^2/s
1	7 N – Deck	0.044	1.337	1.56E-11
5	72 S – Deck	0.055	1.304	1.32E-11
8	44 S – Cap	0.014	0.861	1.05E-11
10	72 S – Cap	0.051	0.956	3.02E-11
11	7 N – Pile Top	0.022	0.743	4.82E-11
13	72 S – Pile Top	0.013	0.828	2.45E-11

Sample ID: Core 1, 7 N - Deck

Chemistry of Concrete
05-27-2017

Chloride Profile Fit Using
 $C_{x,t} = C_s - (C_s - C_i) \cdot \text{erf}(x/\sqrt{4D_a t})$

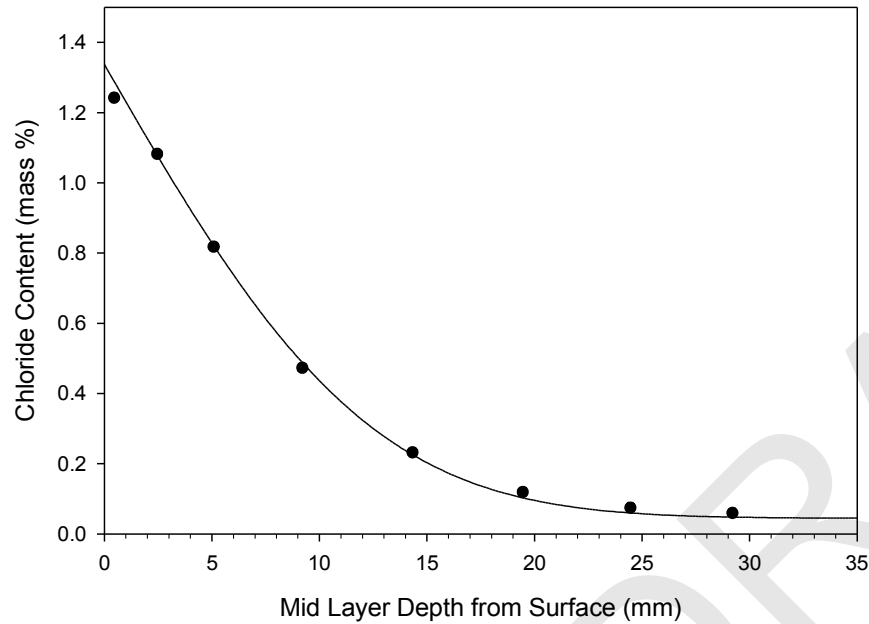

Sample ID: Core 5, 72 S - Deck

Chemistry of Concrete
05-27-2017

Chloride Profile Fit Using
 $C_{x,t} = C_s - (C_s - C_i) \cdot \text{erf}(x/\sqrt{4D_a t})$

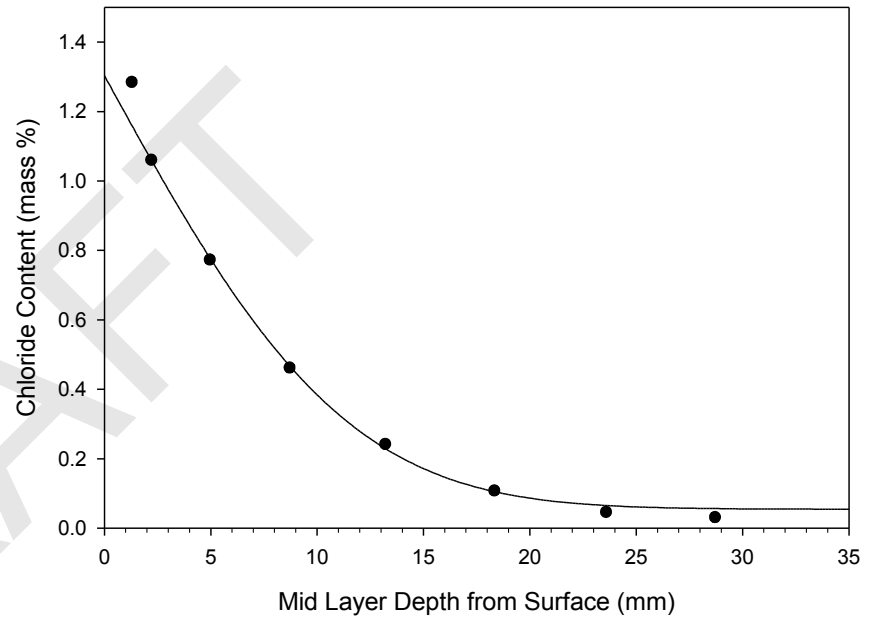

- $C_{x,t}$ chloride concentration, measured at depth x and exposure time t , mass %
- C_s projected chloride concentration at the interface between the exposure liquid and test specimen that is determined by the regression analysis, mass %
- C_i initial chloride-ion concentration of the cementitious mixture prior to submersion in the exposure solution, mass %
- x depth below the exposed surface (to the middle of a layer), m
- D_a apparent chloride diffusion coefficient, m^2/s
- t exposure time, s
- erf the error function $\text{erf}(z) = 2/\sqrt{\pi} \cdot \int \exp(-u^2) du$

Sample ID: Core 8, 44 S - Cap

Chemistry of Concrete
05-27-2017

Chloride Profile Fit Using
 $C_{x,t} = C_s - (C_s - C_i) * (\text{erf}(x/\text{sqrt}(4D_a t)))$

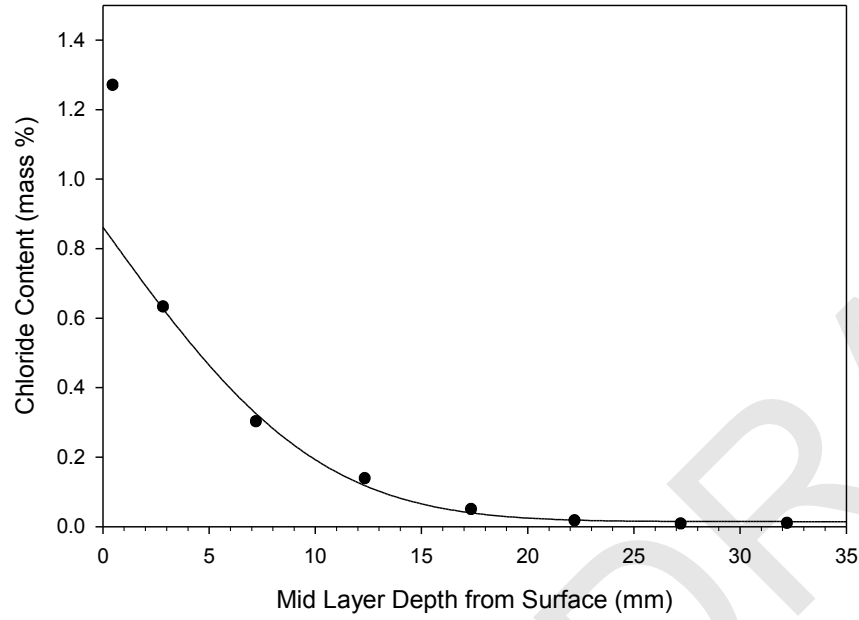

Sample ID: Core 10, 72 S - Cap

Chemistry of Concrete
05-27-2017

Chloride Profile Fit Using
 $C_{x,t} = C_s - (C_s - C_i) * (\text{erf}(x/\text{sqrt}(4D_a t)))$

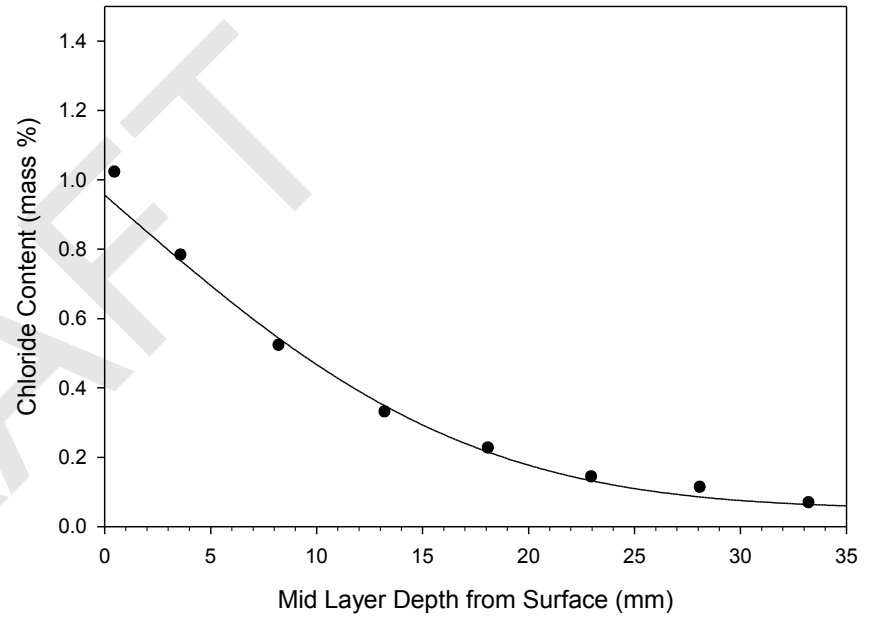

Sample ID: Core 11, 7 N - Pile Top

Chemistry of Concrete
05-27-2017

Chloride Profile Fit Using
 $C_{x,t} = C_s - (C_s - C_i) * (\text{erf}(x/\text{sqrt}(4D_a t)))$

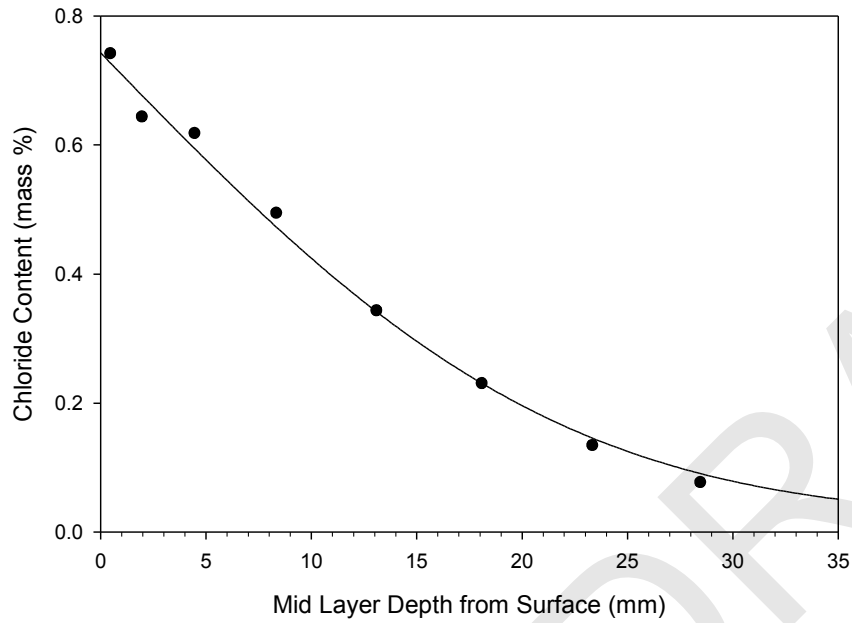

Sample ID: Core 13, 72 S - Pile Top

Chemistry of Concrete
05-31-2017

Chloride Profile Fit Using
 $C_{x,t} = C_s - (C_s - C_i) * (\text{erf}(x/\text{sqrt}(4D_a t)))$

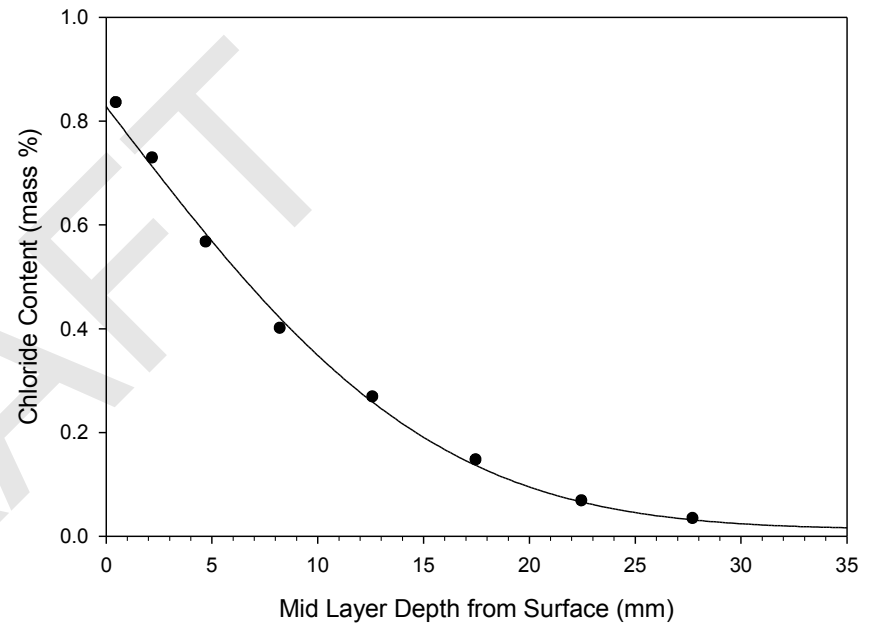



Exposure core #1: As-received profile section mounted on Al base plate



Exposure core #5: As-received profile section mounted on Al base plate



Exposure core #8: As-received profile section mounted on Al base plate

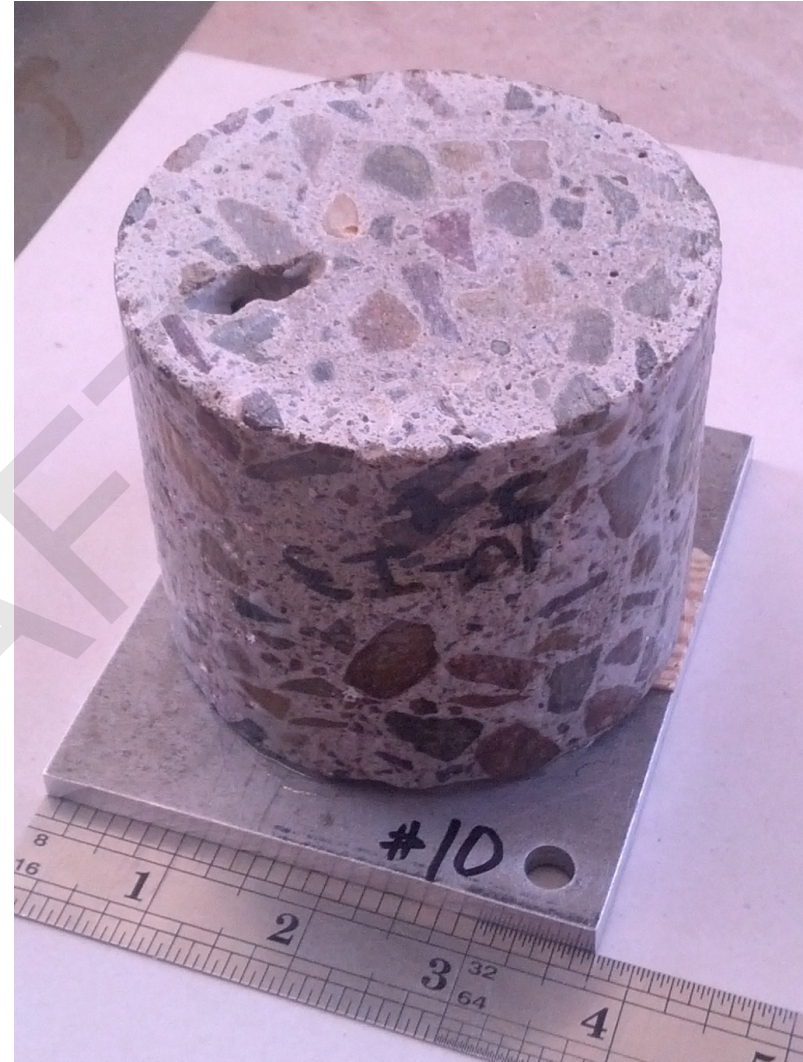

Exposure core #10: As-received profile section mounted on Al base plate



Exposure core #11: As-received profile section mounted on Al base plate



Exposure core #13: As-received profile section mounted on Al base plate



2883 East Spring Street
Suite 300
Long Beach CA 90806
Tel 562.426.3355
Fax 562.426.6424

**Attachment F: Service Life Modeling Results
(Graphs) of 17 Elements Modeled Using Life-365**

DRAFT

Modeling Results of Chloride Content Vs. Depth and Chloride Content Vs. Time at Depths of Reinforcement

1. Soffit Panels

- Results with D_{28D} based on tested results of D_{61Y}
- Results with D_{28D} calculated from lower w/cm limit (petrographic analysis)
- Results with D_{28D} calculated from higher w/cm limit (petrographic analysis)

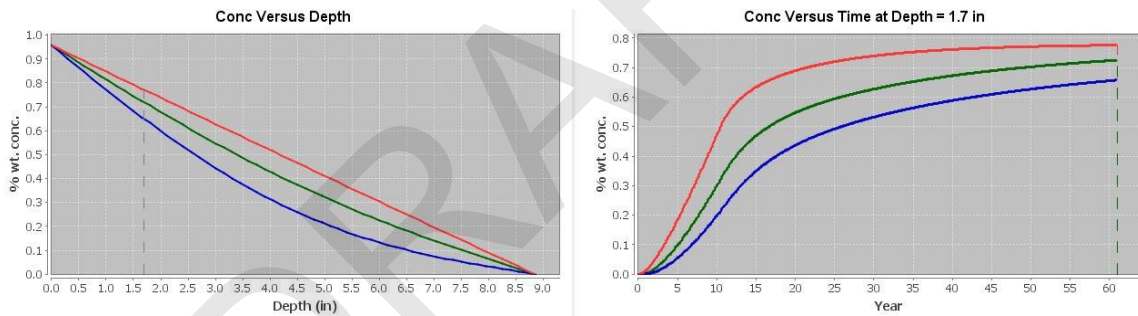

Figure 1 TI sample 1/ MN Sample 7N-Deck

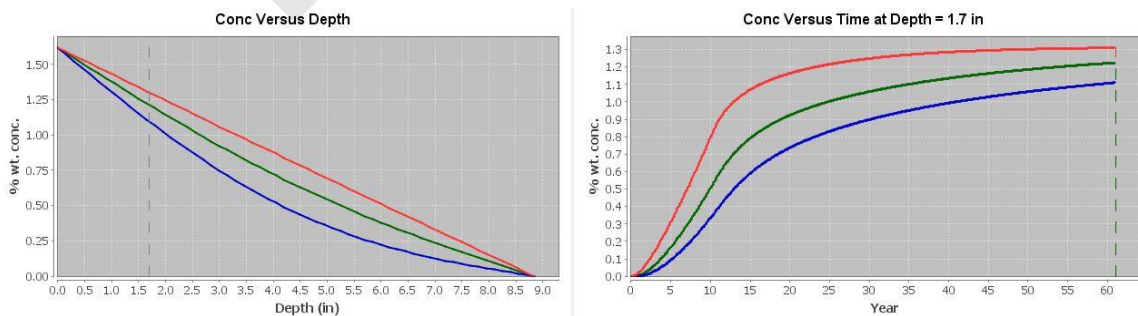

Figure 2 TI sample 2/ MN Sample 17N-Deck

- Results with D_{28D} based on tested results of D_{61Y}
- Results with D_{28D} calculated from lower w/cm limit (petrographic analysis)
- Results with D_{28D} calculated from higher w/cm limit (petrographic analysis)

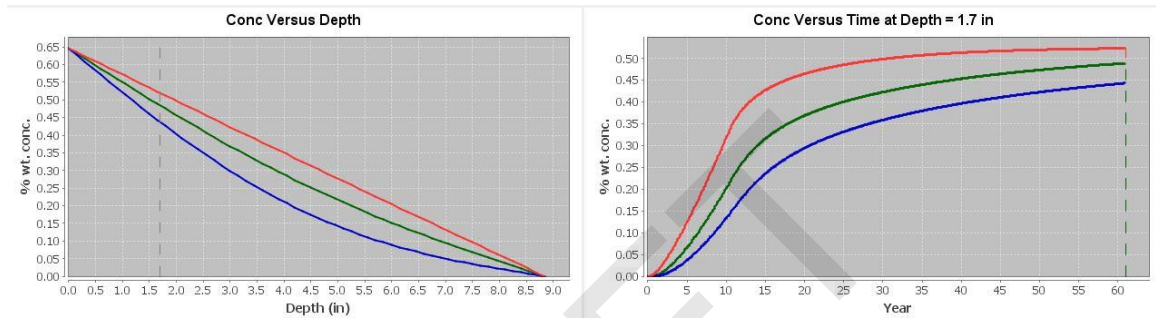

Figure 3 TI sample 3/ MN Sample 44S-Deck

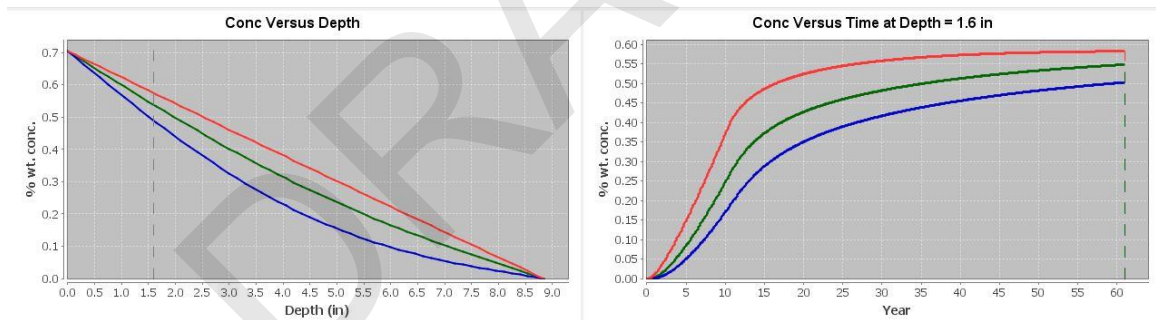

Figure 4 TI sample 4/ MN Sample 55S-Deck

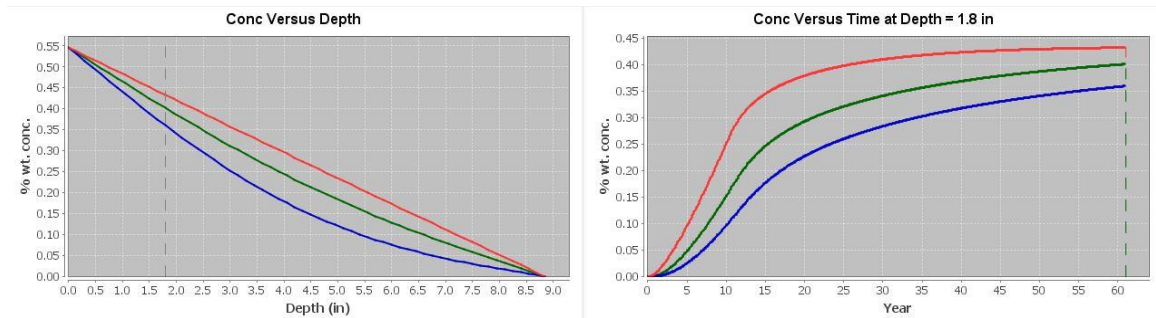

Figure 5 TI sample 5/ MN Sample 72S- East Deck

2. Pile Caps

- Results with D_{28D} based on tested results of D_{61Y}
- Results with D_{28D} calculated from lower w/cm limit (petrographic analysis)
- Results with D_{28D} calculated from higher w/cm limit (petrographic analysis)

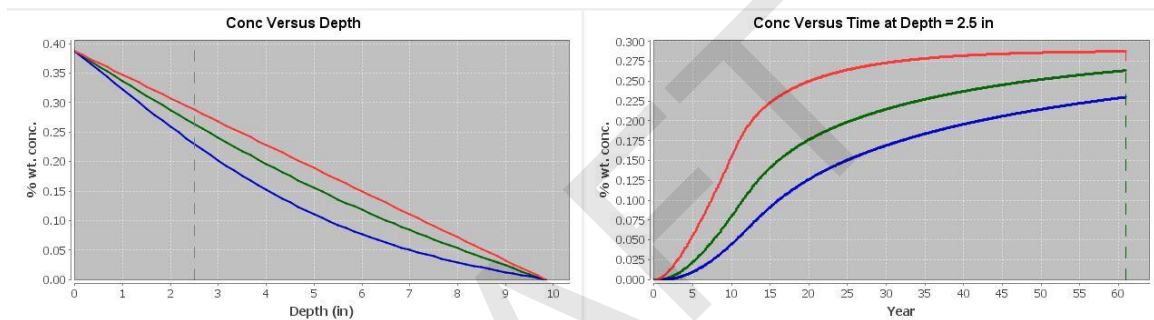

Figure 6 *TI* sample 6/ *MN* Sample 7N-Cap

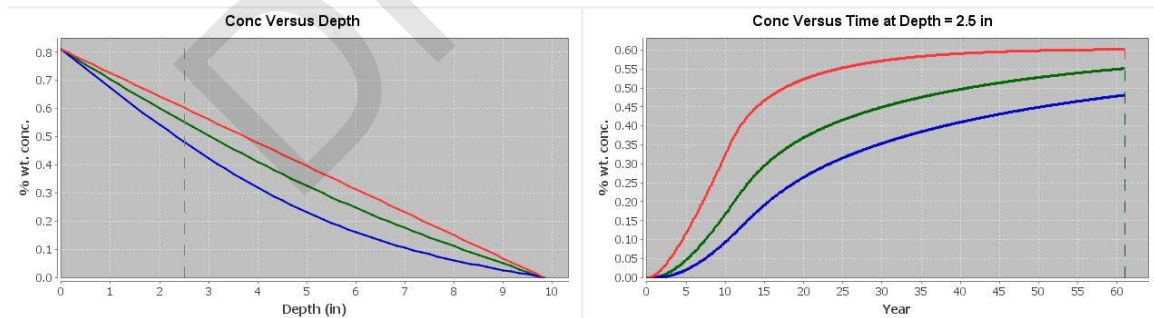

Figure 7 *TI* sample 7/ *MN* Sample 17N-Pile Cap West Side

- Results with D_{28D} based on tested results of D_{61Y}
- Results with D_{28D} calculated from lower w/cm limit (petrographic analysis)
- Results with D_{28D} calculated from higher w/cm limit (petrographic analysis)

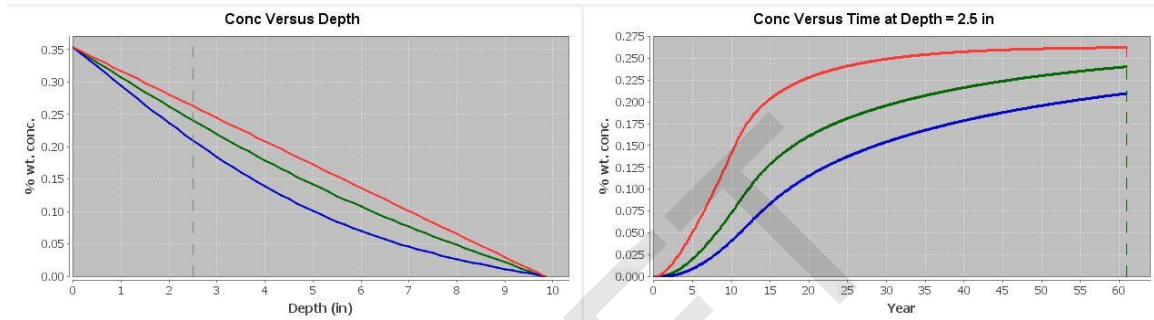

Figure 8 *TI sample 8/ MN Sample 44S-Cap*

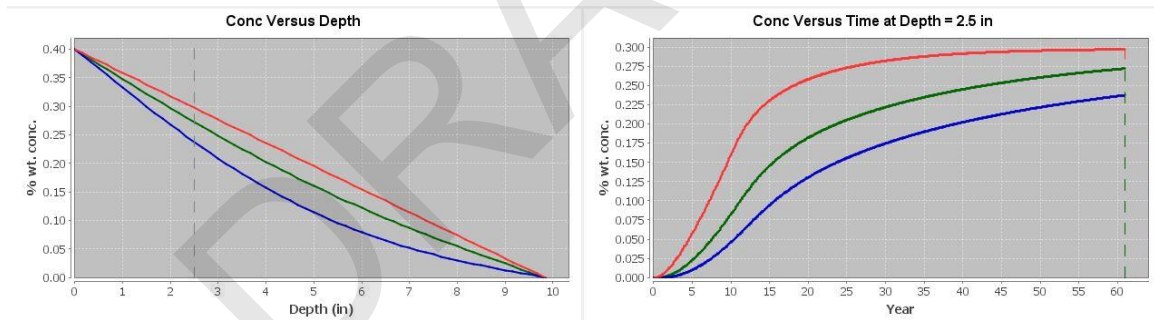

Figure 9 *TI sample 9/ MN Sample 55S- Pile Cap*

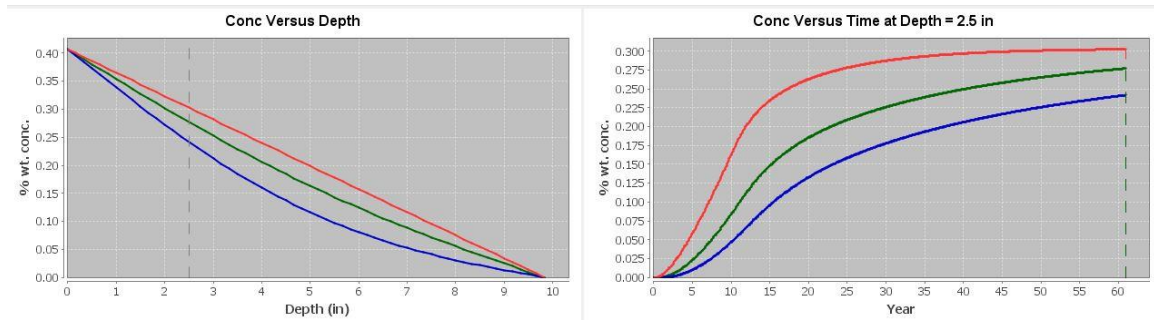

Figure 10 *TI sample 10/ MN Sample 72S- Cap East N. Side of Cap*

3. Piles

- Results with D_{28D} based on tested results of D_{61Y}
- Results with D_{28D} calculated from lower w/cm limit (petrographic analysis)
- Results with D_{28D} calculated from higher w/cm limit (petrographic analysis)

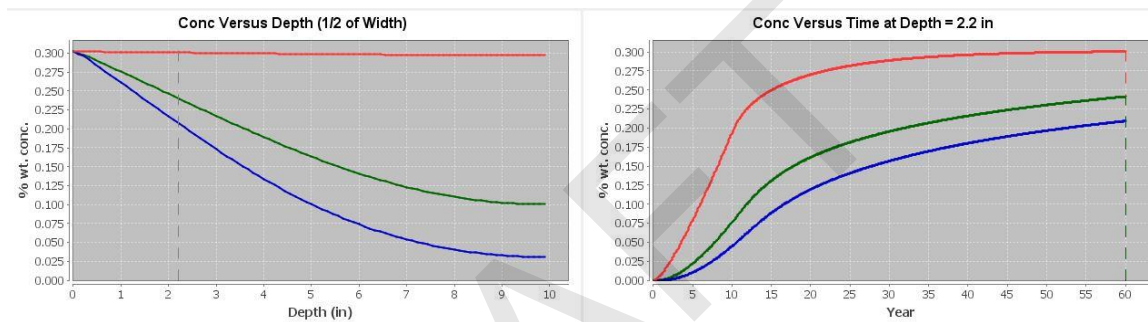

Figure 11 *TI* sample 11/ *MN* Sample 7N- Pile Top North Side

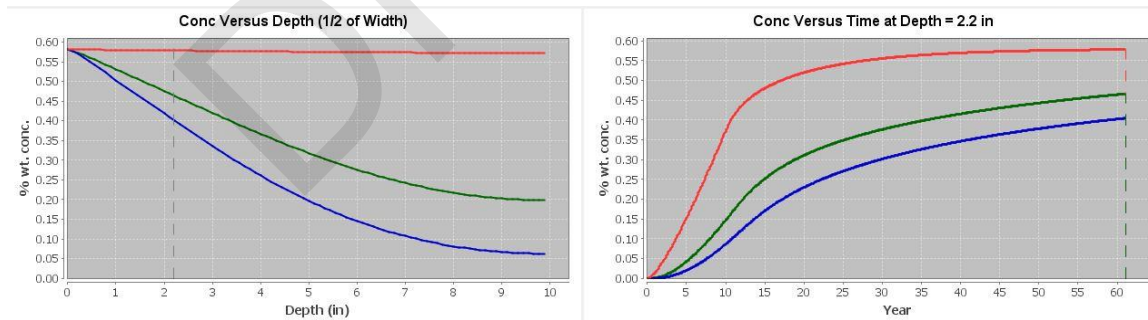

Figure 12 *TI* sample 12/ *MN* Sample 55S- Top Pile

- Results with D_{28D} based on tested results of D_{61Y}
- Results with D_{28D} calculated from lower w/cm limit (petrographic analysis)
- Results with D_{28D} calculated from higher w/cm limit (petrographic analysis)

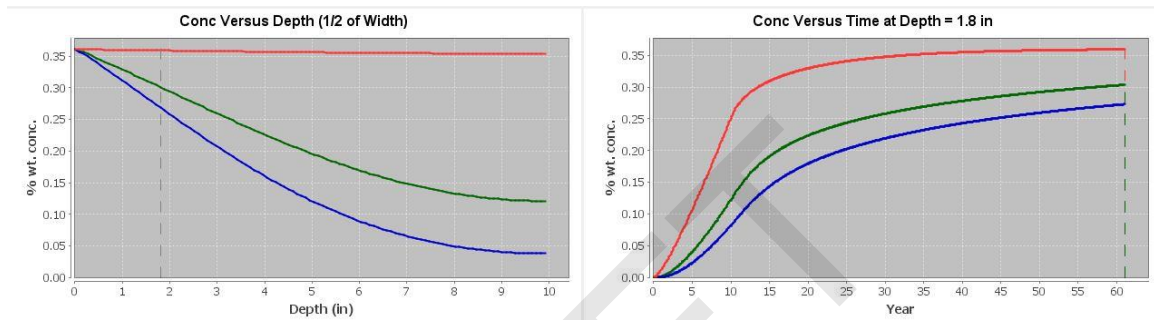

Figure 13 *TI* sample 13/ *MN* Sample 72S- East Pile Tops

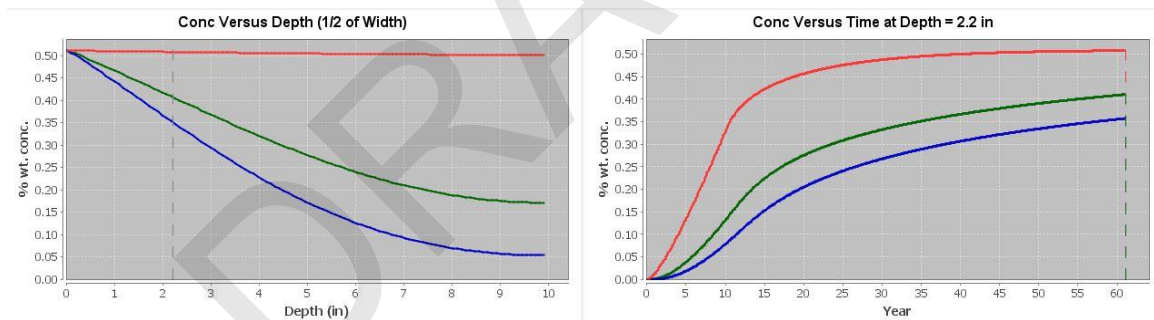

Figure 14 *TI* sample 15/ *MN* Sample 17N- 68" Below Pile

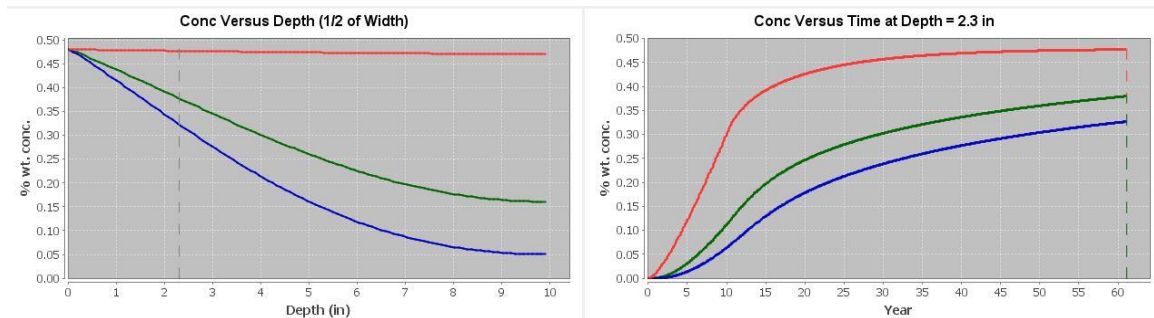

Figure 15 *TI* sample 16/ *MN* Sample 44S- Pile 38" from Cap

- Results with D_{28D} based on tested results of D_{61Y}
- Results with D_{28D} calculated from lower w/cm limit (petrographic analysis)
- Results with D_{28D} calculated from higher w/cm limit (petrographic analysis)

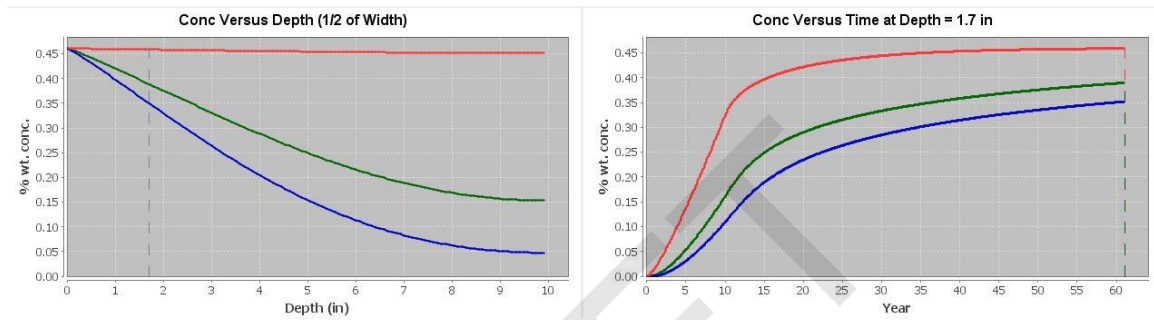

Figure 16 *TI* sample 17/ *MN* Sample 55S

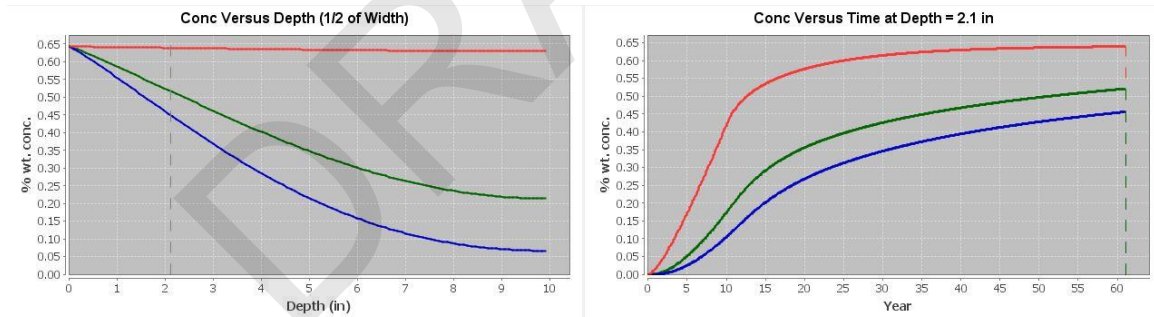

Figure 17 *TI* sample 18/ *MN* Sample 72S - East

APPENDIX C– Background Information

CONCRETE DETERIORATION

Corrosion of Reinforcing Steel

Concrete deterioration in the marine environment takes on many forms. The most prevalent of these is corrosion of the steel reinforcing within the concrete structure. As steel corrodes, it undergoes a volumetric expansion, swelling to more than nine times the original volume. Since the steel is restrained by the surrounding concrete, an outward pressure is exerted on the concrete. This outward pressure is inherently a tensile force, and as concrete is relatively weak in this mode of loading; cracks and “spalling” of the concrete eventually occurs. Spalling leads to exposure of the reinforcing steel to the marine environment, which exacerbates the problem.

Corrosion of steel reinforcing is governed by two processes - the first of these being the pacification of the highly alkaline concrete composition. The second process is the actual corrosion of the reinforcing bar by oxidation.

When first placed, concrete has a high pH value usually ranging from 12.5 to 13.2. This highly alkaline environment allows an oxidized film (Fe_2O_3) to form on the reinforcing steel. This film provides a protective layer around the steel, minimizing the potential for reactions with chloride ions from sea water. Above a pH of 13, the protective film is retained. However, the alkalinity is pacified over time by two processes - the ingress of sea salts and/or by carbonation of the concrete. Sea salts penetrate the concrete through capillary action, and therefore the time to pacification is dependent on the porosity of the concrete. Carbonation is a chemical reaction by which carbon dioxide reacts with calcium hydroxide, the alkaline compound found in fresh concrete, to form calcium carbonate. Calcium carbonate is a neutralized (pH=7) compound, and therefore reduces the high pH concrete environment needed to maintain the beneficial oxidized iron film.

Once the concrete structure has been pacified to the depth of the reinforcing steel, and the oxidized iron film is destabilized, the reinforcement is allowed to corrode. This corrosion is a continual oxidation of the steel bars and is dependent on the availability of oxygen. Since corrosion requires pacification as well as

oxidation, the corrosion critical areas of any structural concrete in the marine environment will be those elements in the tidal or splash zones. These areas provide a constant supply of both aggressive salts and oxygen needed for a sustained corrosive attack. All concrete elements located in the marine environment however are susceptible, with varying rates of corrosion based on the level of exposure to corrosive elements.

As stated in the introduction, steel reinforcement expands as it corrodes. The volume of the oxidized iron product can be more than nine times that of the parent material. The pressure induced by the expansion of corroded steel eventually leads to cracking of the concrete. A condition known as “staining” or “bleeding” is usually apparent when deterioration of this sort is encountered and consists of red rust leaching out of the concrete cracks. As the corrosion of the reinforcing continues, and outward pressure increases, the concrete covering the reinforcing bar eventually spalls out (See Figure I-2). The loss of cover over the bar leads to increased rate of corrosion, and loss of cross-sectional area of the bar.

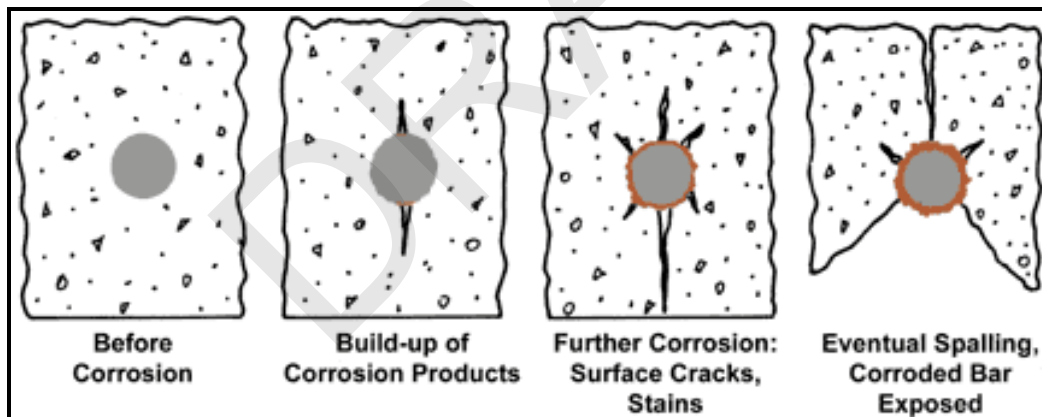

Process of Steel Corrosion-Related Concrete Damage

Deterioration of concrete marine structures may be caused by physical and/or chemical interaction with seawater. "If the structure is fully immersed, the attack on the material by seawater is essentially chemical. In alternating immersion and exposure conditions, the attack is of chemical and physical nature. The mechanical action of the waves, the swelling and shrinkage caused by the alternate saturation and drying, atmospheric conditions (wind, exposure to the sun, freezing) and the

electrochemical corrosion of steel reinforcement are physical processes which add to the chemical destruction processes."

Submerged deterioration of the concrete as observed by this firm has been limited to what has been identified as secondary ettringite formation, sulfate attack, alkali-silica reaction, and corrosion. The electrochemical corrosion of the reinforcing steel is most active in the tidal range and splash zone where both oxygen and the chloride ion are readily available. Below water, the concentration of chlorides and oxygen are less than in the splash zone. However, in time it will reach the reinforcing steel and initiate corrosion.

"The mechanism of concrete corrosion (deterioration) is extremely complex for it depends on a certain number of parameters which are not always easy to isolate and which react in varying degrees according to the composition and the exposure of the material."

Secondary Ettringite Formation

Secondary ettringite formation is defined as ettringite formed by reaction of sulfate ion and aluminate in concrete that has hardened and developed its intended strength. The sulfate which fuels the reaction is supplied from within the concrete. The reaction has also been referred to as "delayed ettringite formation" in the literature.

Ettringite is formed when sulfates (SO_3) react with the free lime (calcium hydroxide (CaOH_2)) to form gypsum (CaSO_4). The gypsum then reacts with tricalcium aluminate (CaAl_2) and water to form ettringite ($\text{Ca}_6\text{Al}_2(\text{SO}_4)_3(\text{OH}_{12})$). Many of these reactants are in the cement and/or seawater.

There are two theories as to the mechanism of expansion caused by this phenomenon. In the swelling theory ettringite forms by a through-solution mechanism. In a saturated CH environment, ettringite crystals are gel-like and colloidal in size. The high surface area results in adsorption of significant quantities of water and strong swelling pressures develop. It has been observed that a higher proportion of ettringite is found at the transition zone between the aggregate and steel than in the bulk matrix. This finding supports the through-solution mechanism of expansion, since constituents must dissolve and diffuse towards the

steel/aggregate surface where the ettringite is precipitated. In the crystal growth theory, expansion is caused by the formation of ettringite at the surface of the reactant grains. The growth of this inner layer pushes other particles out and thus causes expansion. Estimates of crystal growth pressures have been as high as 35,000 psi.

There is some experimental evidence into the various causes and rate of ettringite formation. Some of the components which may affect ettringite formation are elevated temperatures during curing, $(SO_3)/(Al_2O_3)$ ratios, geometry, and humidity.

It appears that sufficiently high heat treatment, temperatures above 60-70o C, contributes to the secondary ettringite formation. When concrete is cured at elevated temperatures, ettringite disappears into a calcium-sulfate-hydrate gel and/or monosulfate, resulting in the sulfate being unusually bound. The bond is such that it allows a later slow release of the sulfate ion into the pore solution which then combines with tricalcium aluminates to produce ettringite.

The ratios of the aluminum oxide (Al_2O_3) and sulfur trioxide (SO_3) in the cement have shown potentials for expansion when the $(SO_3)/(Al_2O_3)$ is greater than 0.67. Later experiments indicate that the sulfur trioxide may have a greater contribution to the expansion. Therefore, the ratio indicating the potential for expansion has been adjusted to $(SO_3)_2/(Al_2O_3)$ greater than 2.

Other items which could contribute to expansion are geometry and humidity. 10x40x160 mm cubes produced much earlier expansions than 40x40x160 mm cubes and specimens in a water soak had earlier expansions than specimens in 60% humidity.

Air-entrainment of the concrete has been shown to reduce the observed expansions due to secondary ettringite formation when comparison is made to non-entrained concrete. The air voids allow the formation of ettringite within the void and prevents the associated micro-cracking caused by expansion in the paste. In a similar fashion, the addition of silica fume has found to be beneficial by increasing the density of the paste in the transition zone at the aggregate/matrix interface.

It should be mentioned that ettringite formation is part of the hydration process used to make concrete. This formation of ettringite is while the concrete is in a

plastic state and helps the concrete develop strength - therefore, this formation is beneficial. This reaction is often referred to as "primary ettringite formation."

Sulfate Attack

Sulfate attack is a type of secondary ettringite formation. It results from the reaction of sulfate ions and aluminates in hardened concrete. The sulfate is typically from an external source - in the case of marine structures the sulfate is in the seawater. It is generally accepted that the primary aggressive constituents of seawater, relative to attack upon the cementitious matrix of Portland cement concrete, are magnesium and sulfate ions.

"Magnesium sulfate also reacts with aluminates that are a constituent of the Portland-cement, primarily tricalcium aluminate, with consequent production of ettringite (high sulfate calcium sulfoaluminate, $3CaO \cdot Al_2O_3 \cdot 3CaSO_4 \cdot 31H_2O$). Formation of ettringite as a solid-state reaction within the cement-paste matrix can be highly destructive to Portland cement concrete because of the increase of solid volume that accompanies the process. Contrariwise, formation of ettringite by a through-solution process whereby the crystals are precipitated within pre-existing openings, such as air voids and cracks, is not harmful."

This reaction can be accompanied by considerable expansion, which causes cracking and spalling of the concrete.

Alkali-Silica Reaction

In the alkali-silica reaction, the alkalis are the metal alkalis sodium and potassium, both of which are present in seawater. For the reaction to occur, reactive silica, sodium and potassium alkalis and water must all be present. It is primarily a reaction between the hydroxyl ions in the pore water of a concrete and certain forms of silica which occasionally occur in significant quantities in aggregate.

"In the alkaline environment within a concrete, an acid/alkali reaction occurs at the accessible surfaces of the silica forming a hydrous silicate. Hydroxyl ions are imbibed into the silica particle and some of the silica oxygen linkages are attacked, weakening the bonding locally. Sodium and potassium cations then diffuse to maintain an electrical neutrality and attract water to form gelatinous alkali-metal-ion hydrous silicate."

The gelatinous silicate increases the solid volume of the concrete. This can cause micro-cracking and macro-cracking, which is destructive to the concrete. If the gel forms in pre-existing air voids, water voids, or when the concrete is in the fresh state, the reaction is not harmful. If the gel forms in the hardened solid concrete, the reaction is harmful.

Sodium and potassium ions and water, two of the constituents of this reaction, are present in seawater. If reactive silicas are present in the concrete, the alkali-silica reaction can occur. However, if the reactive silica content is low and gel growth after the concrete has hardened is of insufficient intensity to induce cracking, the "gel growth occurs without any adverse effect on the concrete. When the reactive silica content is above this level, cracking induced by the gel occurs.

The width of the macro-cracks induced by alkali-silica reaction at the exposed surface of a concrete member can range from less than 0.004 in. to 0.40 in. in extreme cases. The macro-cracks are generally located within 1-2 in. of the exposed surface of a concrete member and are aligned perpendicular to the exposed surface. However, there are exceptions, in the case of a prestressed column a crack depth of approximately 4 ¾" has been recorded.

One example of severe alkali-silica deterioration has occurred at the Friant Dam, constructed during the period 1939 to 1942. In 1980, Boggs noted that alkali-aggregate reaction had occurred to some extent since construction but that the reaction progress appeared to have accelerated from excellent-looking concrete in the late 1960's to wide cracks on the crest and the appurtenant structures in 1980. Deterioration has not yet reached the point of jeopardizing the safe operation of the dam but eventually will.

"Cracking due to ASR (alkali-silica reaction) has been observed within 3 months in one batch of concrete specimens containing a UK (United Kingdom) aggregate stored under water at 20o C, whereas a similar concrete stored in the open took approximately 3.6 years to crack."

This is only one observation; however, it affirms the observed underwater crack predominance. If it is presumed that the observed rate of dry cracking to underwater cracking (14:1) is correct, than the underwater cracks caused by the alkali-silica

reaction should occur in a shorter period of time compared to cracks forming above water – given the same concrete material.

During a previous underwater investigation in San Diego, cracks were observed during the initial inspection of the piles. The inspected piles were approximately 12 years of age. Using the above-mentioned 14:1 rate, this would correlate to above water cracks becoming visible at 168 years of age. This would indicate that it is possible for an aggregate to have a good above water history and not be acceptable for underwater use.

This reaction can be accompanied by considerable expansion, which causes cracking of the concrete, a reduction in the concrete compressive strength and a reduction in the modulus of elasticity.

"Alkali-silica reactivity by itself seldom results in the need to rebuild the structure but, rather, it may weaken or degrade the condition of the structure to the extent that other factors, such as traffic loading, cause premature failure."

APPENDIX D- STRUCTURAL ANALYSIS

DRAFT

MEMORANDUM

To: Adam Bogage

From: Pooja Jain

Prepared By: Stuart Stringer, Pooja Jain

Date: 18 March 2018

Subject: City of San Diego, Ocean Beach Pier - Deck and Pile Repair Strength Evaluation

M&N Job No.: 9487

This memorandum presents the strength evaluation for the Ocean Beach Pier deck and the pile. The deck have been evaluated for the original undamaged condition using the 1965 construction drawings and the damaged condition based on field observations. The piles have been evaluated for the original undamaged condition using the 1965 construction drawings and the a repair detail based on the 1985 Rehabilitation drawings

Scope of Work

The following outlines the scope of work:

- Determine Deck Flexural and Shear Capacity for 30-foot concrete slab design shown on Ocean Beach Pier Rehabilitation Drawings dated 1989.
- Determine Deck Flexural and Shear Capacity for 30-foot concrete slab design shown on Ocean Beach Pier Rehabilitation Drawings dated 1989 for missing strands (progressive one at a time).
- Determine original flexural and shear capacity for the 16" and 20" octagonal concrete piles.
- Develop preliminary jacket design for the 16" and 20" octagonal piles to achieve original capacity using the design shown on Ocean Beach Pier Rehabilitation Project Drawings dated 2001.

The slab spanning 50-feet and slab under the restroom building are included in the scope of work.

References:

The following references were used for the deck and pile strength evaluation:

- "Ocean Beach Fishing Pier" original construction drawings by Ferver-Dorland & Associates dated 1-21-1965. Note that these drawings are labeled as the "As-Built" drawings, but they may not necessarily reflect the actual as-built condition.
- "Ocean Beach Pier Rehabilitation" drawings by Ferver Engineering Company dated 5-22-1985
- "Ocean Beach Fishing Pier Visual Inspection" report by Moffatt & Nichol dated 8-2-2016
- ACI 318-14 "Building Code Requirements for Structural Concrete"
- "Prestressed Concrete Analysis and Design" 2nd Edition, 2004 by Antoine E Naaman

Deck Strength Evaluation:

Assumptions:

The following assumptions have been made regarding during the evaluation of the deck strength.

Precast Deck Panels

- The typical precast panel was taken to be Longitudinal Section C, and Cross Section 2 on SHT 11 of the original construction drawings. The typical panel is 6'8" wide, 8" deep at midspan, and 5.25" deep at the ends. The prestressing strands are centered 1.75" from the panel soffit.
- Based on Note 1 on SHT 11 of the original construction drawings, the typical panels used 5ksi lightweight of normal concrete. For the strength evaluation lightweight concrete has been assumed.
- Based on Note 2 on SHT 11 of the original construction drawings, the typical panels are reinforced with (16) ½" diameter 7-wire uncoated 270ksi stress-relieved strands prestressed to 29kips per strand. This corresponds to 189ksi or $0.7f_{pu}$.
- It is assumed that the prestressing strands have experienced long term stress losses of 45ksi. This is based on long term lump sum stress losses for stress-relieved strand in structural lightweight pretensioned members per Table 3.13 in Naaman, 2004.

Composite Precast/CIP Deck System

- The precast prestressed deck panels are assumed to be fully composite with the CIP topping slab. Stirrups shown in the original construction drawings appear to function as shear friction reinforcing. The explicit evaluation of these stirrups was not made.
- Based on Detail B on SHT 8 of the original construction drawings, the composite deck (precast panel plus CIP topping) is 12" thick. The topping is reinforced with #6 bars @ 8"oc over the pile caps, and #6 bars @ 24" oc at deck midspan. The deck reinforcing has 1.5" clear cover. The bars for negative moments are on the lower layer of the top mat, and a therefore centered 2.4" from the top of the deck.
- It is assumed that the CIP topping slab is 4ksi concrete. The CIP concrete strength is not shown on the original construction drawings provided.

Flexural Strength Analysis

- Plane sections remain plane, flexural strength determined using the strain compatibility method in ACI 318-14 Section 22.2 and 22.3. Analysis was performed using spreadsheets.
- For the positive moment capacity evaluation at midspan, it is assumed the prestressing strands are fully developed and fully stressed.
- For the negative moment capacity near the supports it is assumed that the prestressing strands are not stressed, and do not have sufficient development length to participate in the flexural strength.

Shear Strength Analysis

- The critical shear section was taken to be at the face of the support, where it is assumed the section is effectively non-prestressed due to the proximity of the critical section to the end of the precast/prestressed panel.
- Because the critical shear section is within the negative moment region, the "d" value for the shear strength was taken to be the distance from the slab soffit to the CIP topping reinforcing in tension.

Strength Evaluation:

The strength of the deck has been evaluated at the three following critical locations:

- Midspan for positive moment capacity
- Near support for negative moment capacity
- Near support for shear strength

The primary damage/deterioration is the form of spalling of the soffit concrete, and, corrosion/section loss of the prestressing strands. For each critical section, the strength was evaluated using the original undamaged condition, and the damaged condition based on field observations.

Figures 1 and 2 show the cross section for midspan positive moment in the undamaged and damaged conditions respectively. For the damaged condition, the positive moment was evaluated for each progressive number of missing/broken strands.

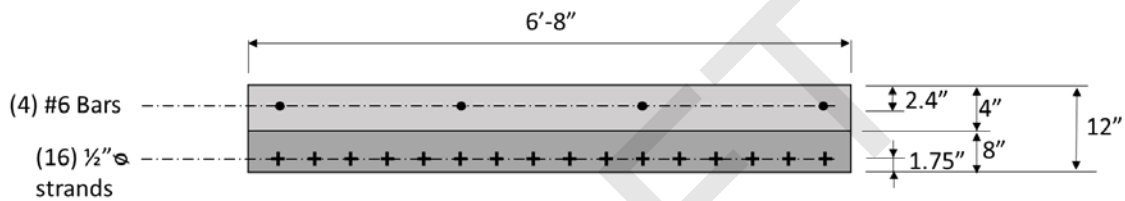

FIGURE 1: Midspan Section – Undamaged Condition

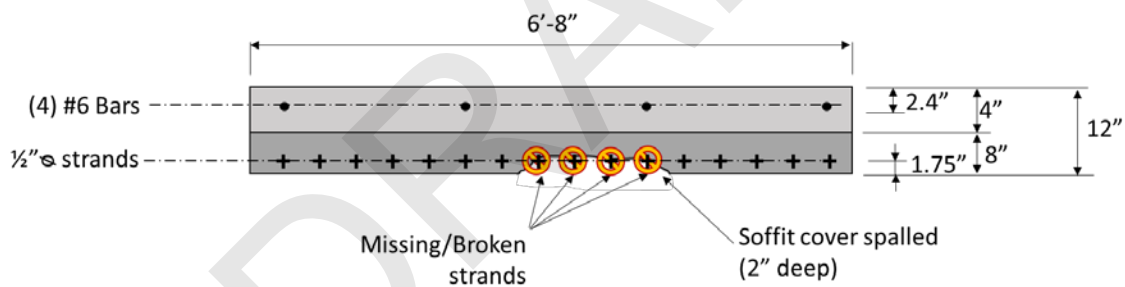

FIGURE 2: Midspan Section – Damaged Condition

Figures 3 and 4 show the cross section near the supports for negative moment and shear in the undamaged and damaged conditions respectively. For the damaged condition, it was assumed the soffit cover concrete was completely spalled to a depth of 2 inches. This is the thickness of concrete measured from the soffit to the top of the prestressing strands as this is most likely the depth of spall that would initiate from corrosion of the prestressing strands. The prestressing strands were not included in the strength of the section.

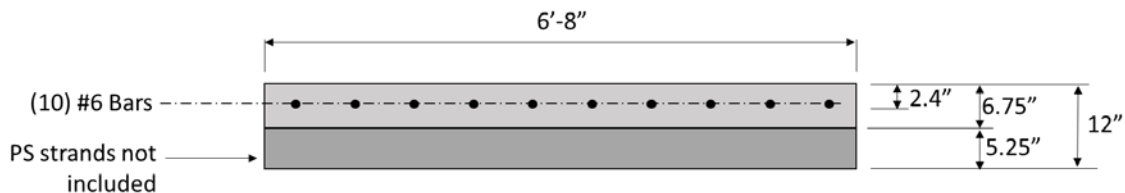

FIGURE 3: Near Support Section– Undamaged Condition

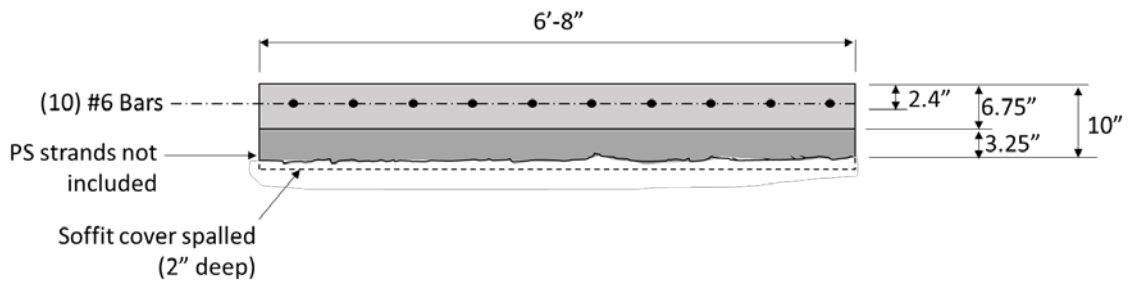

FIGURE 4: Midspan Section – Damaged Condition

DRAFT

Results:

The following summarizes the results of the deck strength analysis:

Figure 5 reports the midspan positive moment capacity for a typical panel 6'-8" wide panel in the undamaged state (listed as 0 strands lost). The figure also presents the reduced positive moment capacity with each subsequent number of strands lost. Note that when all 16 strands are lost, there is a small amount of theoretical residual strength resulting from the top mat reinforcing, this strength is unreliable as the slab is effectively only 2.4" deep.

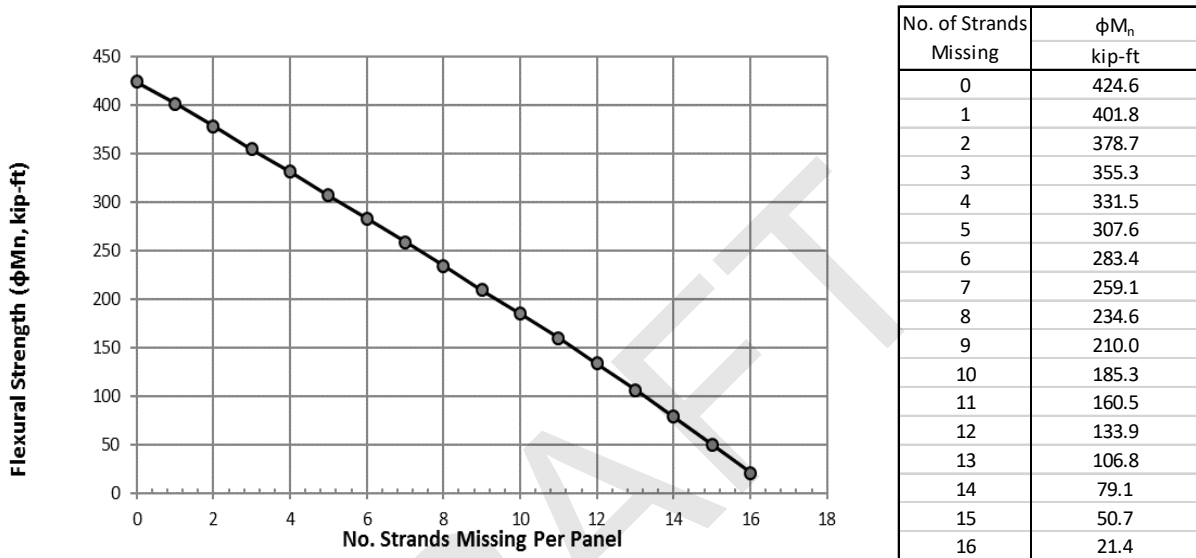

FIGURE 5: Midspan Section – Positive Moment Strength Corresponding to Number of Strands Lost

Table 1 reports the near support negative moment and shear capacity for a typical 6'-8" wide panel in the undamaged and damaged conditions. The damaged condition corresponds to when the slab soffit has spalled.

TABLE 1: Near Support Section – Negative Moment and Shear Strength

Failure Mode	Undamaged Condition	Damaged Condition
Negative Flexure, $\phi M_{n.NEG}$	-182.2 kip-ft	-142.8 kip-ft
Shear, ϕV_n	55 kips	43 kips

Pile Strength Evaluation:

Assumptions:

The following assumptions have been made regarding during the evaluation of the pile strength.

Original Piles

- Based on SHT 3 of the original construction drawings, the piles are either 16" or 20" octagonal prestressed concrete piles (16" from shore to STA 14+00, 20" from STA 14+30 to offshore end).
- Based on Note 2 on SHT 10 of the original construction drawings, the piles use 5ksi normal weight concrete.
- Based on Note 1 on SHT 10 of the original construction drawings, the piles use ½" diameter 7-wire uncoated 270ksi stress-relieved strands prestressed to 29kips per strand, this corresponds to 189ksi or $0.7f_{pu}$. The mild steel reinforcing was assumed to be Grade 60.
- It is assumed that the prestressing strands have experienced long term stress losses of 40ksi. This is based on long term lump sum stress losses for stress-relieved strand in normalweight pretensioned members per Table 3.13 in Naaman, 2004.
- Based on Detail B on SHT 10 of the original construction drawings, the 16" piles are reinforced with (10) ½" diameter strands centered on a circle with a radius of 6-inches. Supplemental mild steel reinforcing is provided in the form of (4) #10 bars. Spiral reinforcing was taken to be W5 wire at a pitch of 3-inches oc.
- Based on Detail B on SHT 10 of the original construction drawings, the 20" piles are reinforced with (16) ½" diameter strands centered on a circle with a radius of 7-inches. Supplemental mild steel reinforcing is provided in the form of (8) #11 bars. Spiral reinforcing was taken to be W5 wire at a pitch of 3-inches oc.

Pile Repair

- Due to the uncertain condition of the original pile reinforcing (rebar/strand section loss could not be determined due to closed corrosion spalls, or access issues) the strength of the repair assumes that none of the existing reinforcing participates in the strength of the repaired section. The new reinforcing of the repaired section is assumed to resist all load. This is conservative.
- The repair concrete was assumed to be 5ksi, the mild steel reinforcing was assumed to be Grade 60.
- The 16" pile repair detail was taken from the 1985 Rehab drawings, and consists of a 25-inch wide square reinforced concrete jacket with 2.5in chamfered corners. The square jacket was reinforced with (12) #6 bars, three located in each corner. Stirrups are #4 bars @ 3-inches oc.
- The rehab drawings did not have a detail for repair of 20" piles, so a similar detail was generated. The jacket is assumed to be 29-inch wide square reinforced concrete jacket with 2.5in chamfered corners. The square jacket is reinforced with (12) #8 bars, three located in each corner. Stirrups are #4 bars @ 3-inches oc.

The Axial-Flexural Strength Analysis

- Plane sections remain plane, flexural strength determined using the strain compatibility method in ACI 318-14 Section 22.2, 22.3, and 22.4.
- P-M interaction diagrams were generated using the program XTRACT.

Shear Strength Analysis

- The shear strength of the original section was taken to be the strength including prestress.
- The shear strength of the repaired section was taken to include no increase from prestress or axial load.

Strength Evaluation:

The strength of the original undamaged piles was evaluated at three cross sections along the length of the pile to capture the various levels of reinforcing where corrosion or damage has occurred (prestressed only, mild steel only, prestressed and mild steel). In addition the repair cross section was analyzed using only the added repair reinforcement. In figures below, unconfined concrete is bright pink, prestressing strands are light pink, and mild steel is black.

Figure 6 shows the cross sections of the original undamaged 16-in octagonal piles.

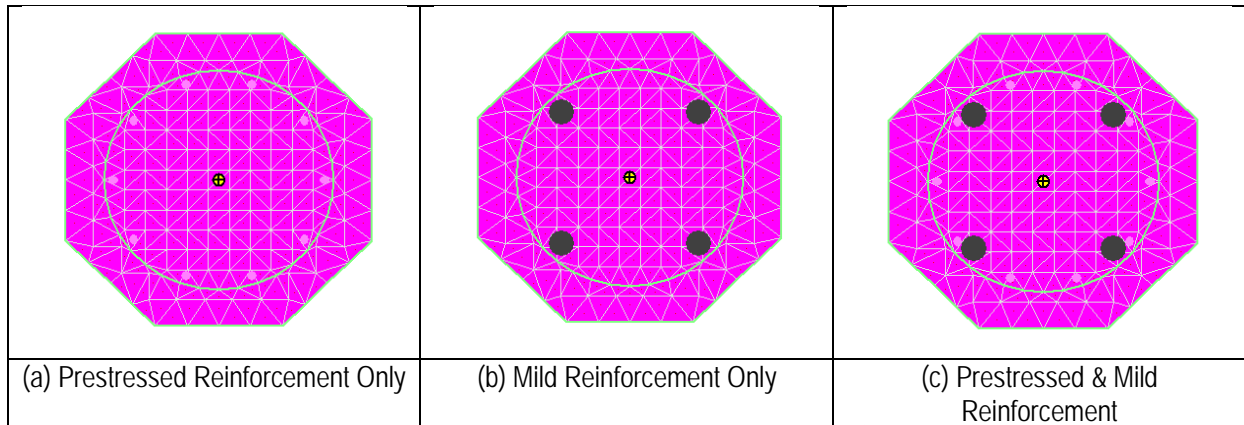

FIGURE 6: 16" Pile – Undamaged Condition

Figure 7 shows the cross section for the repair of the 16-in piles.

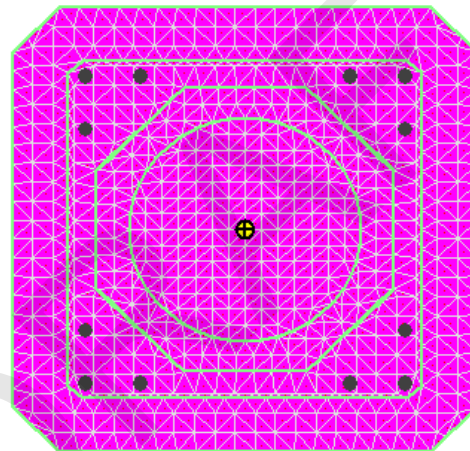

FIGURE 7: 16" Pile – Repaired Condition

Figure 8 shows the cross sections of the original undamaged 20-in piles.

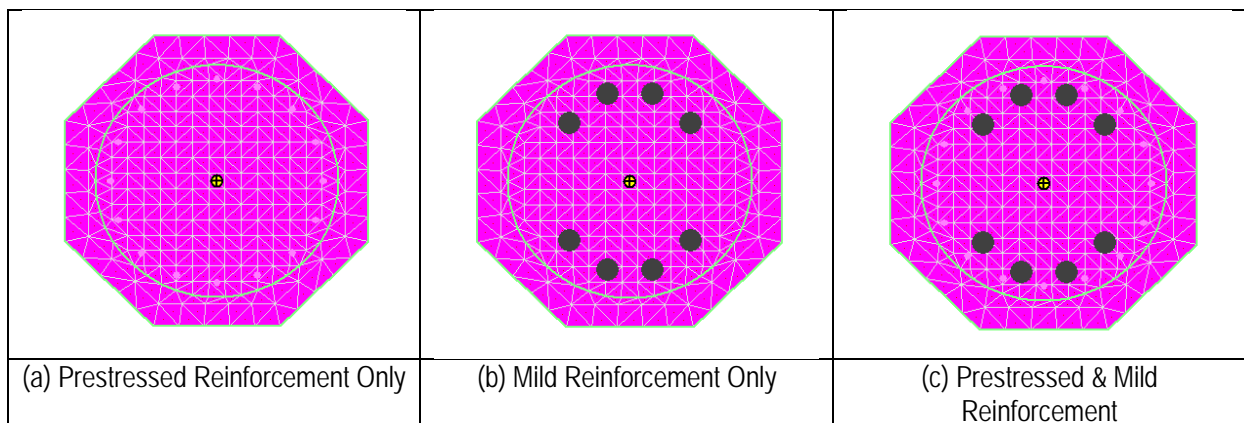

FIGURE 8: 20" Pile – Undamaged Condition

Figure 9 shows the cross section for the repair of the 20-in piles.

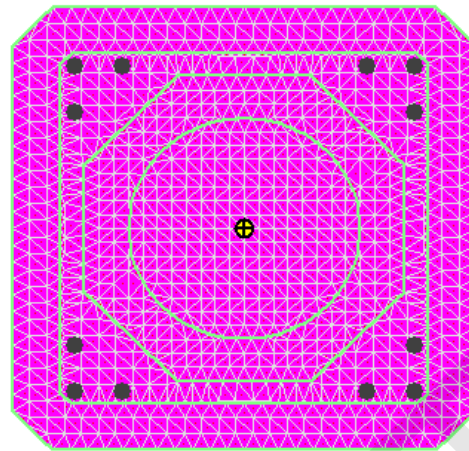

FIGURE 9: 20" Pile – Repaired Condition

In order for the XTRACT analysis results to conform to the nominal strength requirements of ACI 318-14, the Mander unconfined concrete model was applied to the entire cross section. No strength increase over f'_c was incorporated to account for confinement of the core concrete by the spirals/stirrups. The mild reinforcing steel was modelled using an elastically perfectly plastic model with $f_y = 60$ ksi. The prestressing steel model was a nonlinear hardening model with properties defined to match the PCI 270ksi prestressing steel stress-strain relationship. Figures 10, 11, and 12 show the concrete, mild steel, and prestressing steel material models respectively.

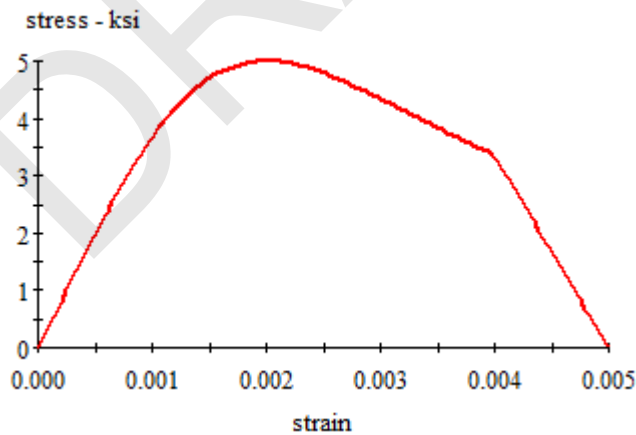

FIGURE 10: Nominal Unconfined Concrete Material Model (5ksi)

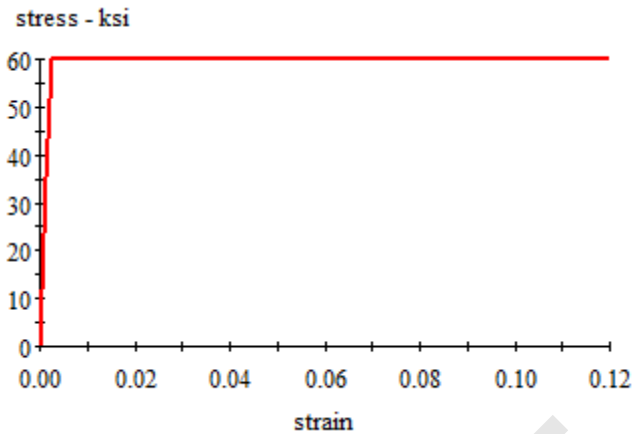

FIGURE 11: Nominal Mild Steel Reinforcing Steel Model (60ksi)

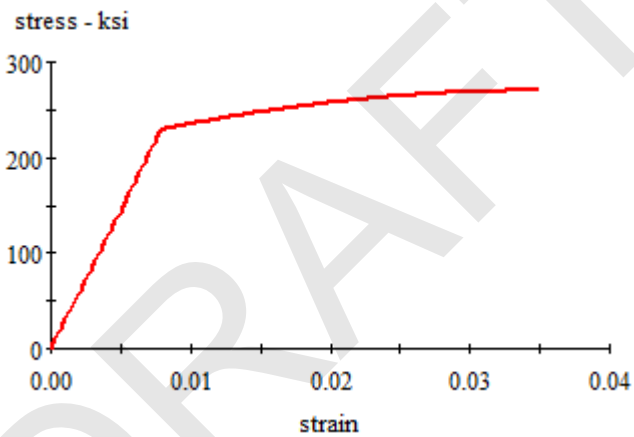

FIGURE 12: Nominal Mild Steel Reinforcing Steel Model (270ksi)

Results:

The following summarizes the results of the pile strength analysis.

Figure 13 shows the results comparing the design P-M interaction curves for the three undamaged 16" pile cross section and the 16" repaired pile cross section. This indicates that the repair detail is significantly stronger than the original undamaged pile sections for all compression axial loads and tension axial loads less than approximately 100kips tension.

Figure 14 shows the results comparing the design P-M interaction curves for the three undamaged 20" pile cross section and the 20" repaired pile cross section. This indicates that the repair detail is significantly stronger than the original undamaged pile sections for all compression axial loads and tension axial loads less than approximately 100kips tension.

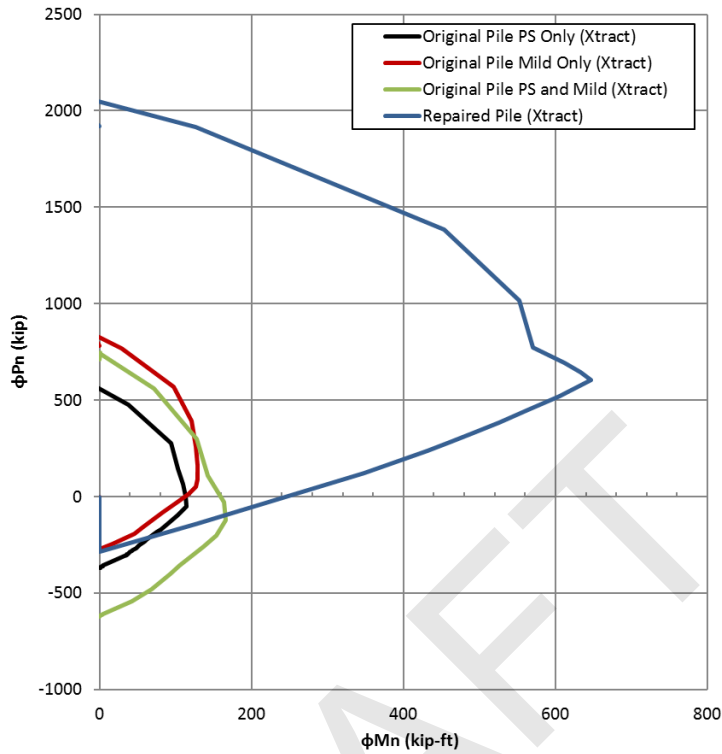

FIGURE 13: Design P-M Interaction Results – 16" Pile

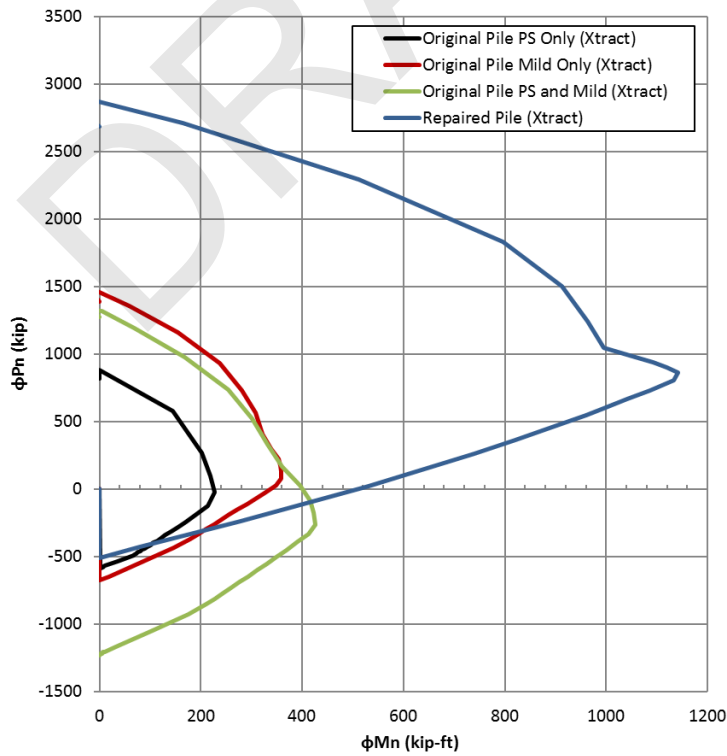

FIGURE 14: Design P-M Interaction Results – 20" Pile

Table 2 summarizes the shear strength of the undamaged original piles and the repaired piles for both the 16" and 20" piles.

TABLE 2: Pile Shear Strength

Pile Size	Original Pile Undamaged Condition	Repaired Condition
16" Pile	41 kips	216 kips
20" Pile	58 kips	263 kips

DRAFT

Appendix A – Reference Drawings

DRAFT

OCEAN BEACH PIER REHABILITATION

SAN DIEGO,

CALIFORNIA

INDEX TO DRAWINGS

1	DRAWING INDEX & MAPS	33	DECK SOFFIT PLAN (47) TO (49) & PILE CAPS
2	NOTES AND PIER SECTION	34	DECK SOFFIT PLAN (49) TO (50) & PILE CAP
3	PIER PLAN	35	DECK SOFFIT PLAN (50) TO (51) & PILE CAP
4	DECK PLAN (1) TO (14)	36	DECK SOFFIT PLAN (51) TO (52) & PILE CAP
5	DECK PLAN (15) TO (51)	37	DECK SOFFIT PLAN (52) TO (53) & PILE CAP
6	DECK PLAN (52) TO (48)	38	DECK SOFFIT PLAN (53) TO (54) & PILE CAP
7	DECK PLAN (49) TO (63)	39	DECK SOFFIT PLAN (54) TO (56) & PILE CAPS
8	DECK PLAN (64) TO (71)	40	DECK SOFFIT PLAN (56) TO (58) & PILE CAPS
9	DECK PLAN (65) TO (77)	41	DECK SOFFIT PLAN (58) TO (60) & PILE CAPS
10	DECK SOFFIT PLAN (1) TO (3) & PILE CAPS	42	DECK SOFFIT PLAN (60) TO (62) & PILE CAPS
11	DECK SOFFIT PLAN (3) TO (5) & PILE CAPS	43	DECK SOFFIT PLAN (62) TO (64) & PILE CAPS
12	DECK SOFFIT PLAN (5) TO (7) & PILE CAPS	44	DECK SOFFIT PLAN (64) TO (65) & PILE CAP
13	DECK SOFFIT PLAN (7) TO (9) & PILE CAPS	45	PILE CAPS
14	DECK SOFFIT PLAN (9) TO (11) & PILE CAPS	46	DECK SOFFIT PLAN (65) TO (67) & PILE CAPS
15	DECK SOFFIT PLAN (11) TO (13) & PILE CAPS	47	DECK SOFFIT PLAN (67) TO (69) & PILE CAPS
16	DECK SOFFIT PLAN (13) TO (15) & PILE CAPS	48	DECK SOFFIT PLAN (69) TO (71) & PILE CAPS
17	DECK SOFFIT PLAN (15) TO (17) & PILE CAPS	49	DECK SOFFIT PLAN (71) TO (73) & PILE CAPS
18	DECK SOFFIT PLAN (17) TO (19) & PILE CAPS	50	DECK SOFFIT PLAN (73) TO (75) & PILE CAPS
19	DECK SOFFIT PLAN (19) TO (21) & PILE CAPS	51	DECK SOFFIT PLAN (75) TO (77) & PILE CAPS
20	DECK SOFFIT PLAN (21) TO (23) & PILE CAPS	52	DECK SOFFIT PLAN (77) TO (79) & PILE CAPS
21	DECK SOFFIT PLAN (23) TO (25) & PILE CAPS	53	DECK SOFFIT PLAN (79) TO (81) & PILE CAPS
22	DECK SOFFIT PLAN (25) TO (27) & PILE CAPS	54	DECK SOFFIT PLAN (81) TO (83) & PILE CAPS
23	DECK SOFFIT PLAN (27) TO (29) & PILE CAPS	55	TYPICAL REPAIRS
24	DECK SOFFIT PLAN (29) TO (31) & PILE CAPS	56	REPAIR & WELDING DETAILS
25	DECK SOFFIT PLAN (31) TO (33) & PILE CAPS	57	TYPICAL PIER REPAIRS
26	DECK SOFFIT PLAN (33) TO (35) & PILE CAPS	58	EXPANSION JOINT & GATE DETAILS
27	DECK SOFFIT PLAN (35) TO (37) & PILE CAPS	59	GATE DETAILS
28	DECK SOFFIT PLAN (37) TO (39) & PILE CAPS	60	STAIR REPAIR DETAILS & UTILITY WORK SCHEDULE
29	DECK SOFFIT PLAN (39) TO (41) & PILE CAPS	61	GUARD RAIL REPAIR DETAILS
30	DECK SOFFIT PLAN (41) TO (43) & PILE CAPS	62	PIPE SUPPORT DETAILS
31	DECK SOFFIT PLAN (43) TO (45) & PILE CAPS	63	PILE JACKETING REPAIR DETAIL
32	DECK SOFFIT PLAN (45) TO (47) & PILE CAPS		

MAPS

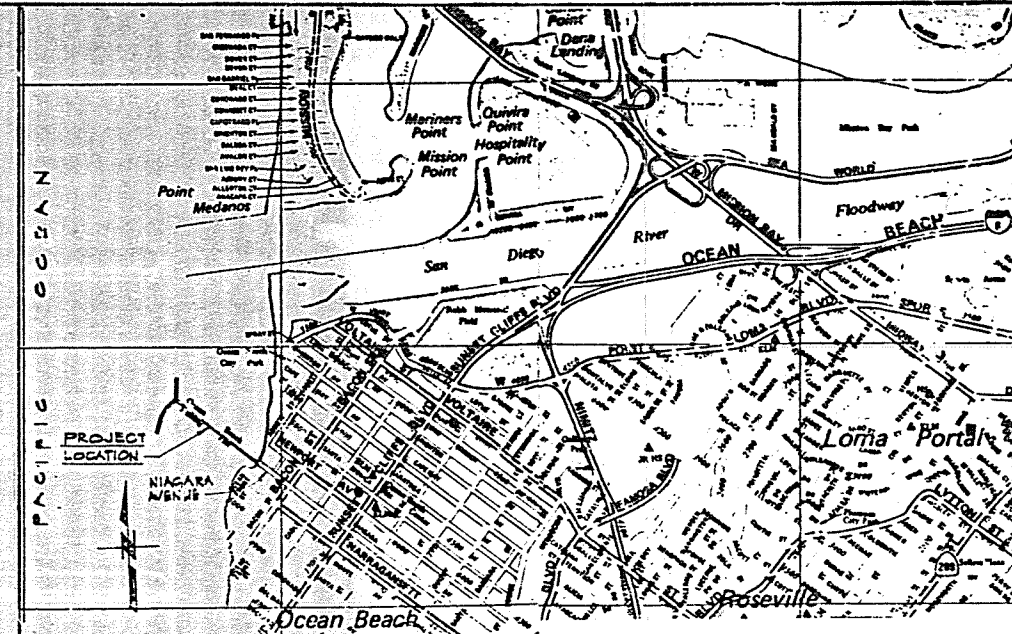
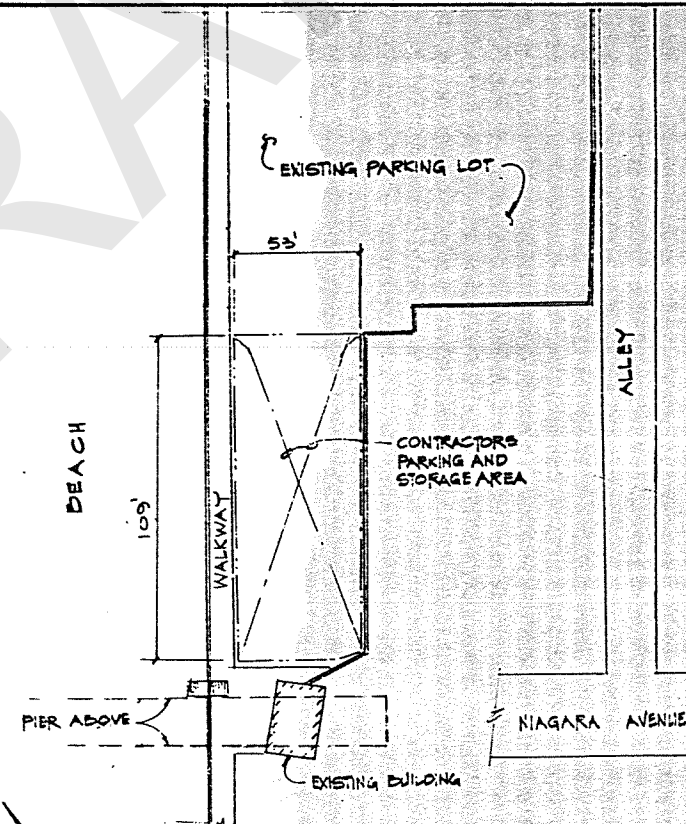

GRAPHIC SCALE: NONE

OCEAN BEACH PIER REHABILITATION
SAN DIEGO, CALIFORNIA

SPECIFICATION NO. 5833

DRAWING INDEX AND MAPS

CITY OF SAN DIEGO, CALIFORNIA
ENGINEERING DEPARTMENT
SHEET 1 OF 2 SHEETS

DESCRIPTION	BY	APPROVED	DATE	FILMED
ORIGINAL	Thomas L. Cook	5/15/89		
W.O. NO. 118063 DIVISION HEAD James P. Deane DESIGN ENGINEER CONTROL CERTIFICATE 212-1689 CONTRACTOR: B.A.G. D.E.S. 8/2/89 INSPECTOR: D. SCHWABERZ DATE COMPLETE: 12/19/89 2002-1				



F FEVER ENGINEERING
COMPANY
SAN DIEGO, CALIFORNIA

AS-BUILT

NOTES

GENERAL

- THE CONTRACTOR SHALL VERIFY ALL EXISTING CONDITIONS AND DIMENSIONS BEFORE STARTING WORK. NOTIFY ENGINEER OF ANY DISCREPANCIES.
- DRAWINGS OF THE EXISTING PIER, DRAWING NO. 11880-D ARE AVAILABLE FOR REVIEW AT:
CITY OF SAN DIEGO
DEPARTMENT OF ENGINEERING AND DEVELOPMENT
1222 FIRST AVE
SAN DIEGO, CA 92101
ATTENTION: JIM PRESCOTT, PROJECT ENGINEER
TEL. NO. (619) 236-6998
NOTE TO CONTRACTOR: PLANS OF THE EXISTING PIER ARE, IN GENERAL, ORIGINAL CONTRACT DRAWINGS AND DO NOT NECESSARILY SHOW NORMAL CONSTRUCTION TOLERANCES, VARIANCES AND MODIFICATIONS EVEN THOUGH MARKED "AS-BUILT". ALSO OVER THE YEARS MODIFICATIONS HAVE BEEN MADE, PARTICULARLY TO THE UTILITY SYSTEMS AND GUARD RAILING. THESE MODIFICATIONS ARE NOT REFLECTED ON THE EXISTING DRAWINGS.
- THE CONTRACTOR SHALL PROVIDE ALL MEASURES NECESSARY TO PROTECT THE EXISTING FACILITY DURING THE REHABILITATION WORK. SUCH MEASURES SHALL INCLUDE, BUT ARE NOT LIMITED TO, BRACING AND SHORING OF THE STRUCTURE DUE TO CONSTRUCTION LOADS. THE CONTRACTOR AT HIS OWN EXPENSE, SHALL RETAIN THE SERVICES OF A LICENSED CIVIL ENGINEER TO DESIGN THE BRACING, SHORING, AND SUPPORTING PLATFORMS REQUIRED FOR THE WORK.
- THE PIER WAS ORIGINALLY DESIGNED FOR A LIVE LOAD OF 100 P.S.F. DUE TO THE DETERIORATION CONDITION OF THE PIER, THE LIVE LOAD CAPACITY HAS BEEN REDUCED.
- ALL TESTING AND INSPECTION SERVICES THAT ARE REQUIRED SHALL BE PERFORMED BY A TESTING LABORATORY APPROVED BY THE CITY OF SAN DIEGO.
- FOR THE PURPOSE OF THESE DRAWINGS THE PIER BETWEEN BENTS (1) & (6) IS ASSUMED TO BE IN THE EAST-WEST DIRECTION AND THE PIER BETWEEN (7) & (11) IS ASSUMED TO BE IN THE NORTH-SOUTH DIRECTION.

GENERAL REPAIR NOTES

THE FOLLOWING GENERAL PROCEDURE IS TO BE FOLLOWED IN THE RESTORATION WORK.

- REMOVE ALL LOOSE AND UNSOUND CONCRETE. CHECK TOP AND BOTTOM SURFACES OF THE DECK BY TAPPING OR CHAIN DRAGGING TO LOCATE DETERIORATED AREAS THAT ARE NOT READILY APPARENT.
- CLEAN ALL CRACKS BY SANDBLASTING OR HYDROBLASTING.
- AT SEVERELY CRACKED AND SPALLED AREAS REMOVE ALL DETERIORATED AND UNSOUND CONCRETE TO SOUND CONCRETE.
- AFTER THE REMOVAL OF DETERIORATED CONCRETE THE EXISTING REINFORCING (BARS AND STRANDS) THAT IS EXPOSED SHALL BE SANDBLASTED TO REMOVE THE CORROSION.
- REINFORCING THAT HAS CORRODED TO WHERE LESS THAN 80% OF THE ORIGINAL BAR AREA IS REMAINING, SHALL BE REPLACED WITH NEW REINFORCING BARS OF THE SAME SIZE. SEE DETAILS FOR WELDING OF NEW BARS TO EXISTING.
- ALL EXPOSED REINFORCING BARS AND PRESTRESSING STRANDS SHALL BE COATED AFTER SANDBLASTING WITH SPECIFIED COATING MATERIAL.
- ALL REPAIR AREAS SHALL BE THOROUGHLY CLEANED WITH FRESH WATER IMMEDIATELY PRIOR TO APPLYING REPAIR MATERIAL.
- APPLY SPECIFIED BONDING MATERIAL TO REPAIR AREA PRIOR TO THE INSTALLATION OF THE PATCHING MATERIAL.
- APPLY ALL PATCHING AND REPAIR MATERIAL IN STRICT CONFORMANCE WITH THE MANUFACTURER'S RECOMMENDATIONS.
- ALL EXPOSED TOP, BOTTOM, AND SIDE SURFACES OF THE PIER DECK INCLUDING STAIR AND ALL SURFACES OF FILE CAPS SHALL BE SANDBLASTED TO REMOVE ALL FOREIGN MATERIAL IN PREPARATION FOR THE APPLICATION OF THE SPECIFIED COATING MATERIAL.
- ALL RESTORED AREAS SHALL BE BROUGHT BACK TO THE ORIGINAL SHAPE AND SURFACE.
- THE CONTRACTOR SHALL HAVE AT THE JOB A COPY OF THE MANUFACTURER'S PRINTED LITERATURE FOR ALL THE REPAIR MATERIALS AND COATINGS THAT ARE TO BE USED ON THE PROJECT.
- A FULL TIME TRAINED IN-FIELD MANUFACTURER'S REPRESENTATIVE SHALL ASSIST THE CONTRACTOR. THIS REPRESENTATIVE SHALL BE PRESENT DURING THE INITIAL STAGES OF EACH TYPE OF REPAIR WORK. IN ADDITION THIS REPRESENTATIVE SHALL PERIODICALLY BE PRESENT TO INSURE THAT THE MATERIALS ARE BEING PROPERLY INSTALLED.
- THE APPLICATION OF ALL REPAIR MATERIALS AND COATINGS SHALL BE PERFORMED BY A CONTRACTOR APPROVED BY THE MATERIALS MANUFACTURERS.

LEGEND - KEY TO REPAIRS

THE NUMBERS, I.E. (1), (2) ..., SHOWN ON THE DRAWINGS, SHEET 4 THRU 54, INDICATE THE TYPE OF DISTRESS WHERE THE FOLLOWING REPAIRS ARE REQUIRED.

- CRACKS IN PIER DECK OR SOFFIT SLAB OR DECK EDGE TO BE REPAIRED PER DETAIL (7/55) LENGTH OF CRACK IS INDICATED ON PLANS.
- AREAS IN PIER DECK OR SOFFIT SLAB WHERE SPALLS, CLOSELY SPACED CRACKS, EXPOSED REINFORCING, DELAMINATIONS, AND DETERIORATED CONCRETE HAVE OCCURRED. REPAIR PER DETAILS. (7/55) & (8/55) AREA OF REPAIR IS INDICATED ON PLANS.
- PILE CAP DETERIORATION INDICATED BY CRACKS, SPALLS, EXPOSED REINFORCING REPAIR PER DETAIL (7/55) & (8/55) VOLUME OF REPAIR IS INDICATED ON PLANS.
- VERTICAL CRACKS AND CONCRETE SPALLS IN PILES ABOVE WATER TO BE REPAIRED PER DETAIL (7/55) LENGTH OF CRACK IS INDICATED ON PLANS.
- NEW CONCRETE GRADE BEAMS TO BE INSTALLED PER DETAIL (8/57).
- NEW CONCRETE BEAMS TO BE INSTALLED IN PIER DECK PER DETAIL (A/57).
- CRACKS IN PILES BELOW WATER TO BE REPAIRED PER DETAIL (F/55) LENGTH OF CRACK IS INDICATED ON PLANS.

INSPECTION REQUIRED BY CONTRACTOR

- IN ADDITION TO THE AREAS AND ITEMS OF REPAIR SHOWN ON THE DRAWINGS, THE CONTRACTOR SHALL INSPECT THE PIER DECK AND SOFFIT FOR ADDITIONAL DETERIORATED AREAS. CONTRACTOR SHALL ALSO INSPECT ALL PILES ABOVE THE WATER LINE FOR ADDITIONAL CRACKS, SPALLS AND DETERIORATION.
- ADDITIONAL DETERIORATED AREAS, CRACKS OR SPALLS FOUND SHALL BE REPORTED TO THE CITY'S INSPECTOR

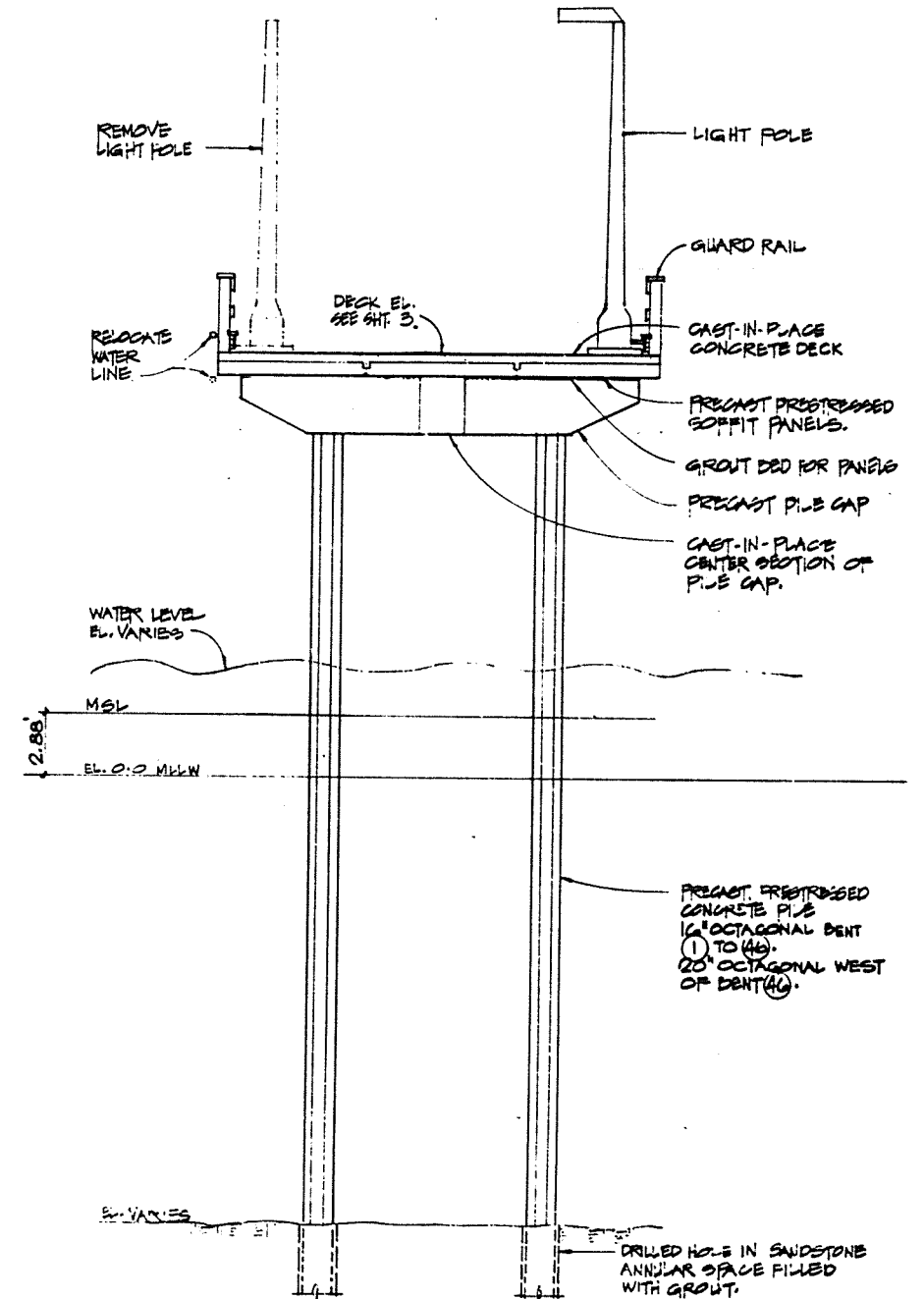

(A/2) PIER SECTION
1/4" = 1'-0"

GRAPHIC SCALE 1/4" = 1'-0" 0' 1' 2' 3' 4' 5' 6' 7'		OCEAN BEACH PIER REHABILITATION SAN DIEGO CALIFORNIA	
		NOTES AND PIER SECTION	SHT. NO. 2
CITY OF SAN DIEGO, CALIFORNIA ENGINEERING DEPARTMENT SHEET 2 OF 63 SHEETS		W.O. NO. 118903	
<i>Thomas L. Cook</i> 5-15-89 THOMAS L. COOK DATE		<i>James Bennett</i> DATE FILMED	
FERVER ENGINEERING COMPANY SAN DIEGO, CALIFORNIA		CONTRACTOR BUILT 826 D.E.S. 18/2/81	212-1689
		INSPECTOR D. SCALAPETZ DATE COMPLETED 1-19-1987	25002-2-D

AS-BUILT

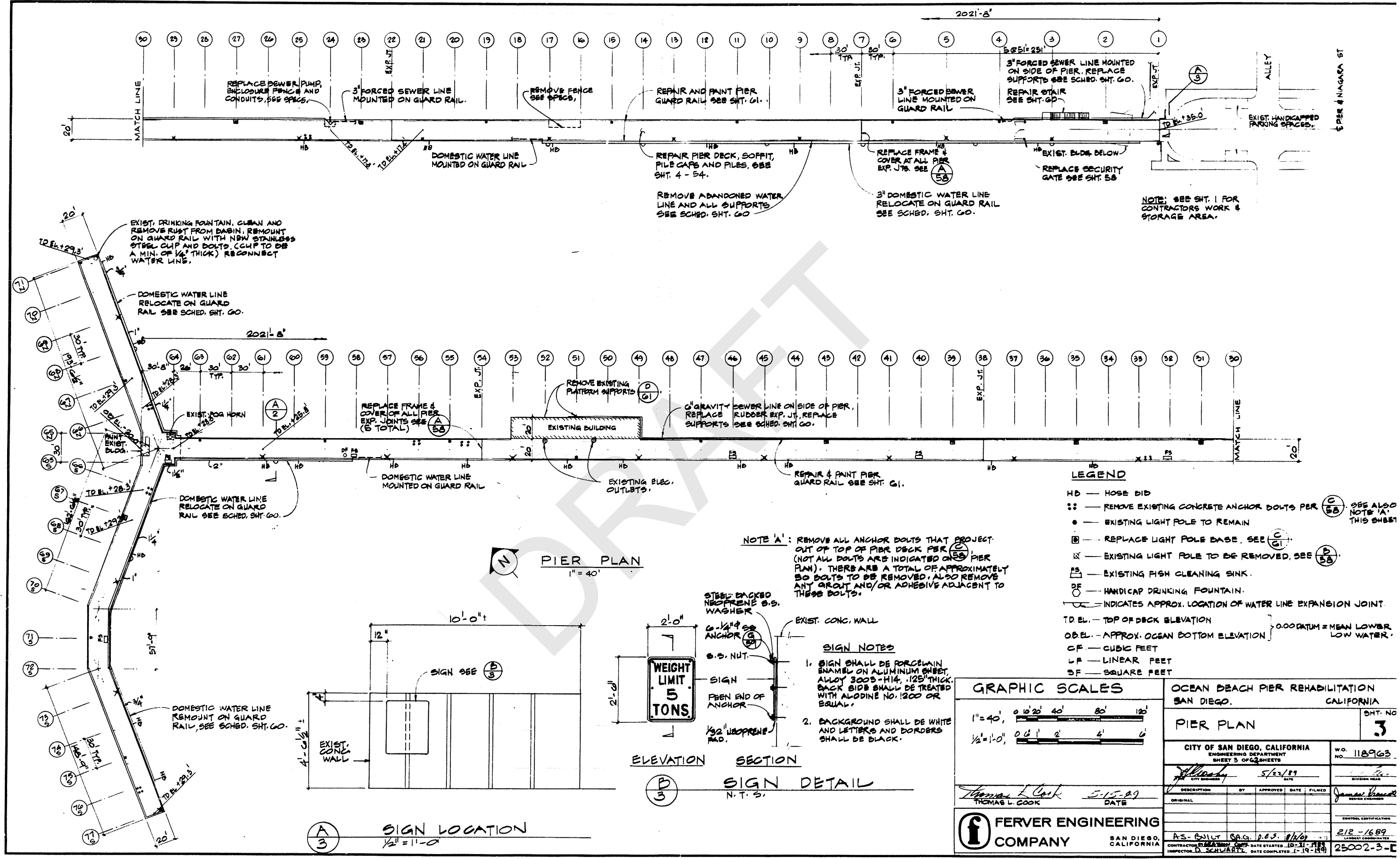

REPLACE SEWER PUMP, ENCLOSURE PUMP AND CONDUITS, SEE SPECS.

3" FORCED SEWER LINE MOUNTED ON GUARD RAIL.

REMOVE FENCE SEE SPECS.

REPAIR AND PAINT PIER GUARD RAIL SEE SHT. G1.

3" FORCED SEWER LINE MOUNTED ON GUARD RAIL

3" FORCED SEWER LINE MOUNTED ON SIDE OF PIER. REPLACE SUPPORTS SEE SCHED. SHT. G0. REPAIR STAIR SEE SHT. G0.

EXIST. DRINKING FOUNTAIN. CLEAN AND REMOVE RUST FROM BASIN. REMOUNT ON GUARD RAIL WITH NEW STAINLESS STEEL CLIP AND BOLTS. (CLIP TO BE A MIN. OF 1/2" THICK) RECONNECT WATER LINE.

DOMESTIC WATER LINE RELOCATE ON GUARD RAIL SEE SCHED. SHT. G0.

REPLACE FRAME & COVER OF ALL PIER EXP. JOINTS SEE (A) 58 (6 TOTAL)

REMOVE EXISTING PLATFORM SUPPORTS (D) 61

6" GRAVITY SEWER LINE ON SIDE OF PIER. REPLACE RUBBER EXP. JT, REPLACE SUPPORTS SEE SCHED. SHT. G0.

DOMESTIC WATER LINE RELOCATE ON GUARD RAIL SEE SCHED. SHT. G0.

DOMESTIC WATER LINE MOUNTED ON GUARD RAIL

EXISTING ELEC. OUTLETS.

REPAIR & PAINT PIER GUARD RAIL SEE SHT. G1.

PIER PLAN
1" = 40'

NOTE 'A': REMOVE ALL ANCHOR BOLTS THAT PROJECT OUT OF TOP OF PIER DECK PER (C) 58 (NOT ALL BOLTS ARE INDICATED ON PIER PLAN). THERE ARE A TOTAL OF APPROXIMATELY 50 BOLTS TO BE REMOVED. ALSO REMOVE ANY GROUT AND/OR ADHESIVE ADJACENT TO THESE BOLTS.

STEEL BACKED NEOPRENE S.S. WASHER

EXIST. CONC. WALL

SIGN NOTES

- SIGN SHALL BE PORCELAIN ENAMEL ON ALUMINUM SHEET, ALLOY 3003-H14, .125" THICK. BACK SIDE SHALL BE TREATED WITH ALODINE NO. 1200 OR EQUAL.
- BACKGROUND SHALL BE WHITE AND LETTERS AND BORDERS SHALL BE BLACK.

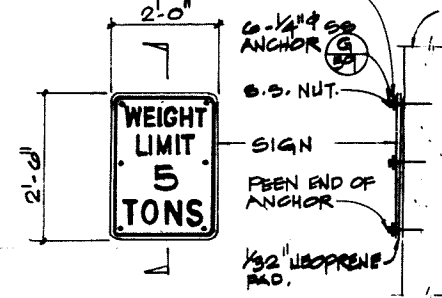

ELEVATION SECTION
SIGN DETAIL
N.T.S.

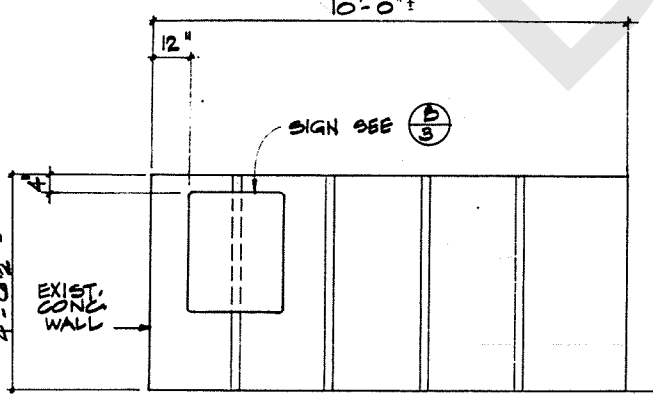

SIGN LOCATION
1/2" = 1'-0"

LEGEND

- HD — HOSE BID
- ⊘ — REMOVE EXISTING CONCRETE ANCHOR BOLTS PER (C) 58 SEE ALSO NOTE 'A' THIS SHEET
- — EXISTING LIGHT POLE TO REMAIN
- ⊠ — REPLACE LIGHT POLE BASE, SEE (C) 61
- ⊗ — EXISTING LIGHT POLE TO BE REMOVED, SEE (D) 58
- FS — EXISTING FISH CLEANING SINK.
- DF — HANDICAP DRINKING FOUNTAIN.
- — INDICATES APPROX. LOCATION OF WATER LINE EXPANSION JOINT.
- TD EL. — TOP OF DECK ELEVATION
- OB EL. — APPROX. OCEAN BOTTOM ELEVATION } 0.00 DATUM = MEAN LOWER LOW WATER.
- CF — CUBIC FEET
- LF — LINEAR FEET
- SF — SQUARE FEET

GRAPHIC SCALES

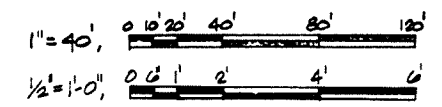

OCEAN BEACH PIER REHABILITATION SAN DIEGO, CALIFORNIA		SHT. NO. 3
PIER PLAN		
CITY OF SAN DIEGO, CALIFORNIA ENGINEERING DEPARTMENT SHEET 3 OF 2 SHEETS	W.O. NO. 118963	
THOMAS L. COOK CITY ENGINEER	5/21/89 DATE	
DESCRIPTION	BY	APPROVED
ORIGINAL		DATE
FERVER ENGINEERING COMPANY SAN DIEGO, CALIFORNIA		CONTROL CERTIFICATION
AS-BUILT S.A.G. P.E.S. 8/16/89		212-1689
CONTRACTOR: R. SCHWARTZ, DATE STARTED: 10-31-88, DATE COMPLETED: 1-19-89		25002-3-C

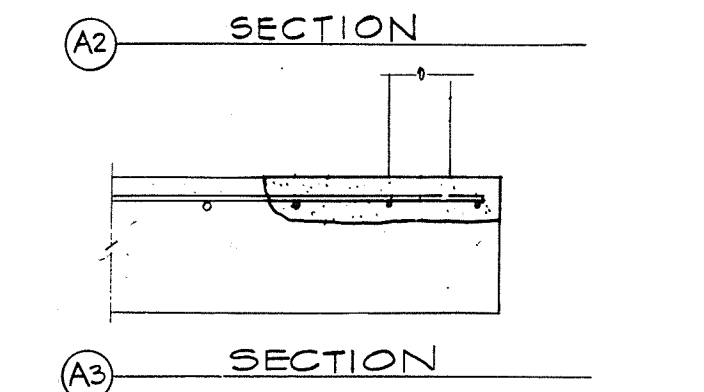
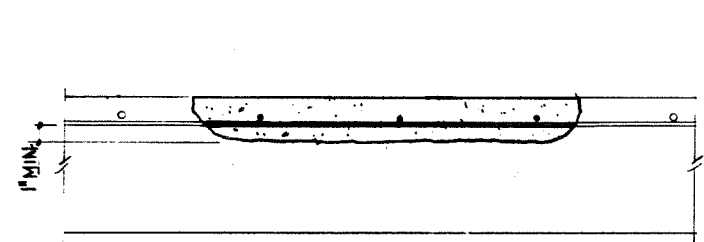
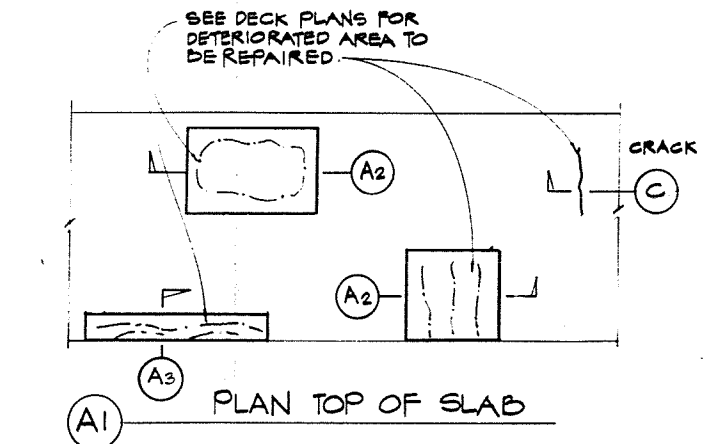

- NOTES FOR REPAIRS TO TOP DECK**
- SAW CUT SLAB APPROX. 1/2" DEEP AROUND AREA TO BE REPAIRED. DO NOT CUT ANY REINFORCING STEEL.
 - REMOVE ALL DETERIORATED AND UNSOUND CONCRETE TO A MIN. OF 1" BELOW THE EXISTING REINFORCING STEEL AND AS REQUIRED TO REACH SOUND CONCRETE.
 - SANDBLAST EXPOSED REINFORCING STEEL TO REMOVE ALL RUST AND CONCRETE.
 - PROVIDE FORMS AT EDGE OF PIER AND WHERE REQUIRED.
 - COAT ALL REINFORCING STEEL WITH SPECIFIED COATING MATERIAL.
 - BLOW OUT ALL SAND, DUST & FOREIGN MATERIAL. DAMPEN WITH CLEAN FRESH WATER AND REMOVE ALL STANDING WATER.
 - COAT SURFACE OF CONCRETE WITH THE SPECIFIED BONDING MATERIAL.
 - FILL AREA WITH SPECIFIED POLYMER CONCRETE.
 - AFTER PATCH HAS SET PROVIDE A LIGHT BROOM FINISH TO MATCH EXISTG. DECK
 - CURE PATCH IN ACCORDANCE WITH SPECIFICATIONS.
 - COAT ENTIRE TOP SURFACE & EDGE OF PIER WITH SPECIFIED COATING MATERIAL, TWO COATS.
 - REMOVE HANDRAIL POST & PIPE ANCHORS AS REQUIRED TO MAKE THE DECK REPAIRS. REPLACE AFTER DECK REPAIR HAVE BEEN COMPLETED.

(A) 55 REPAIR FOR DECK TOP SURFACE

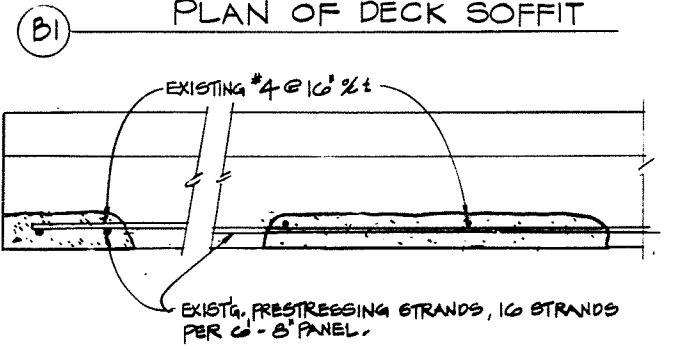
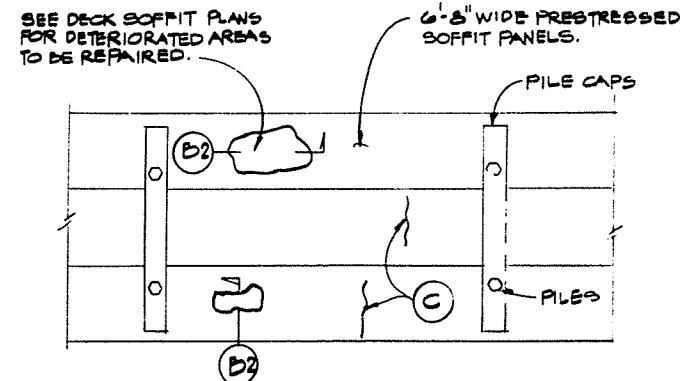

- NOTES FOR DECK SOFFIT REPAIR**
- REMOVE ALL DETERIORATED AND UNSOUND CONCRETE TO A MIN. OF 1" ABOVE THE EXISTING CORRODED STRANDS AND REINF. BARS AND AS REQUIRED TO REACH SOUND CONCRETE.
 - SANDBLAST ENTIRE SLAB SOFFIT AREA TO REMOVE ALL FOREIGN SUBSTANCE FROM CONCRETE. SANDBLAST EXPOSED STRANDS AND REINFORCING TO REMOVE ALL RUST AND CONCRETE.
 - WASH ENTIRE SURFACE OF SLAB SOFFIT WITH CLEAN FRESH WATER.
 - IF 3 STRANDS IN ANY ONE 6'-8" WIDE PRESTRESSED SLAB ARE LOST DUE TO CORROSION, PROVIDE NEW CONCRETE BEAMS PER DETAIL (A) 57
 - FILL REPAIR AREA WITH SPECIFIED POLYMER CONCRETE MATERIAL BY TROWELING OR SHOTCRETE. CURE IN ACCORDANCE WITH SPECS.
 - APPLY SPECIFIED COATING IN TWO COATS OVER ENTIRE SOFFIT OF PIER.

(B) 55 REPAIR FOR SPALLS & DELAMINATED AREAS IN SOFFIT OF DECK

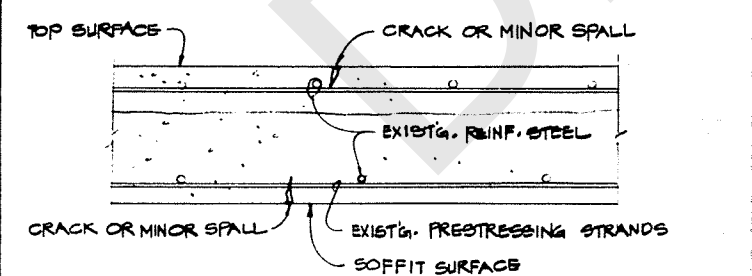

- REMOVE ALL DETERIORATED CONCRETE TO SOUND CONCRETE.
- PRESSURE INJECT EPOXY INTO CRACK FOR ENTIRE LENGTH. PROVIDE SEAL ALONG SURFACE AND INJECTION PORTS AT APPROX. 12" OR AS NEEDED TO INSURE THAT CRACK IS FILLED WITH EPOXY.
- IF DURING ITEM (1) THE CRACK BECOMES MORE OF A SPALL THAN A CRACK, REPAIR SIMILAR TO DETAILS (A) 55 & (B) 55.

(C) 55 CRACK REPAIR IN TOP AND SOFFIT OF DECK SLAB

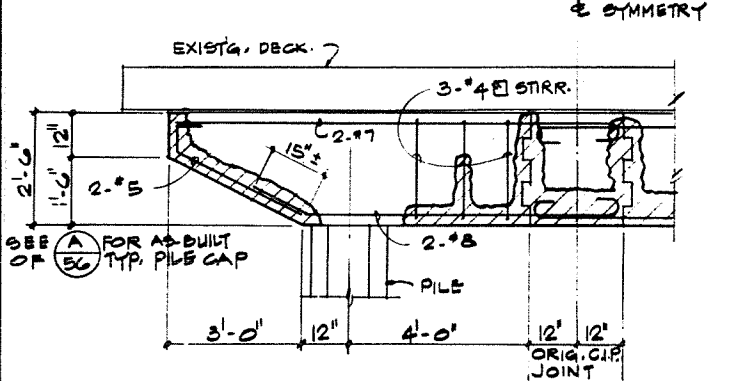

- NOTES FOR PILE CAP REPAIR**
- REMOVE ALL DETERIORATED, SPALLED, CRACKED AND UNSOUND CONCRETE TO SOUND CONCRETE.
 - WHERE REINFORCING IS EXPOSED BY (1), REMOVE ALL CONCRETE TO A MIN. OF 1" AROUND REINFORCING BAR IN THE DETERIORATED AREA.
 - SANDBLAST EXPOSED REINFORCING STEEL TO GRAY METAL, AND SANDBLAST ENTIRE CONG. SURFACE OF PILE CAP TO REMOVE ALL FOREIGN MATTER.
 - WHERE REINF. BAR HAS LESS THAN 80% OF ITS ORIGINAL AREA LEFT, REMOVE BAR IN THIS 80% OR LESS AREA AND REPLACE WITH NEW BAR OF SAME SIZE & SHAPE. WELD TO EXISTG. BAR PER DETAIL (C) 59
 - WASH ENTIRE SURFACE OF CAP INCLUDING REPAIR AREA WITH CLEAN FRESH WATER.
 - COAT ALL EXPOSED REINFORCING STEEL WITH SPECIFIED COATING MATERIAL.
 - COAT ALL CONCRETE SURFACES IN REPAIR AREA WITH SPECIFIED BONDING MATERIAL.
 - FILL REPAIR AREA WITH SPECIFIED POLYMER CONCRETE MATERIAL. TROWEL OR SHOTCRETE NEW CONCRETE INTO ALL CHIPPED AREAS WITH SUFFICIENT PRESSURE TO ENSURE COMPLETE FILLING. WHERE REPAIR AREA IS TOO LARGE FOR TROWELING IN NEW CONCRETE, FORM SOFFIT AND SIDES OF CAP AND POUR CONCRETE INTO PLACE. NEW CONCRETE TO BE ESSENTIALLY FLUSH WITH EXISTING PILE CAP, BUT PROVIDE A MIN. OF 3" CLEAR COVER TO REINFORCING.
 - CURE NEW CONCRETE IN ACCORDANCE WITH SPECIFICATIONS. IF REPAIR AREA WAS FORMED, FORMS MUST REMAIN IN PLACE FOR 24 HOURS MIN.
 - APPLY SPECIFIED COATING MATERIAL TO ENTIRE SURFACE OF PILE CAP, SIDES, SOFFIT AND ENDS.

(D) 55 TYPICAL PILE CAP REPAIR

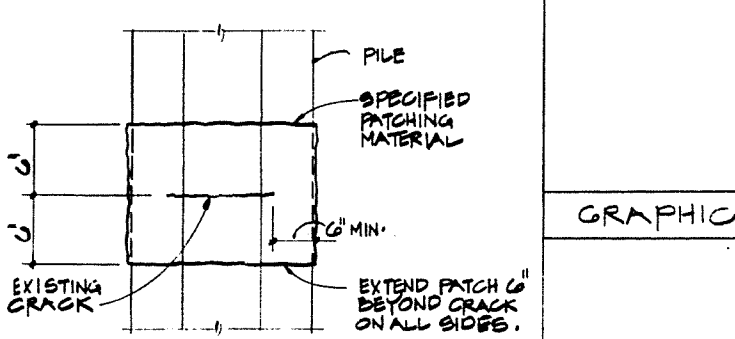

- CLEAN PILE OF ALL MARINE GROWTH AND FOREIGN MATERIAL TO SOUND CONCRETE.
- APPLY SPECIFIED PATCHING MATERIAL AT CRACK & KNEAD MATERIAL TO APPROX. 1/4" IN THICKNESS.

(E) 55 REPAIR FOR CRACKS IN PILE UNDER WATER

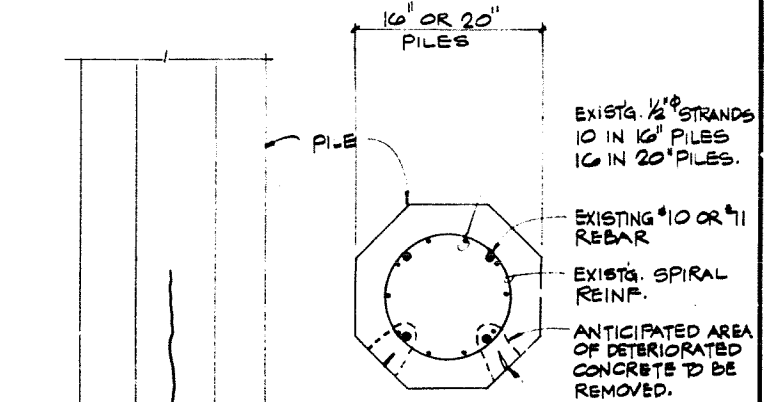

- NOTES FOR PILE CRACK REPAIR**
- CHIP OUT AND REMOVE ALL DETERIORATED AND UNSOUND CONCRETE AROUND CRACK.
 - IF CRACK AND UNSOUND CONCRETE EXTENDS TO EXISTING STEEL REINFORCING, REMOVE ALL UNSOUND CONCRETE FROM AROUND REINFORCING.
 - CLEAN ALL EXPOSED STEEL TO REMOVE ALL RUST.
 - COAT ALL EXPOSED STEEL WITH SPECIFIED COATING.
 - COAT CONCRETE IN REPAIR AREA WITH SPECIFIED BONDING MATERIAL.
 - PATCH AREA WITH SPECIFIED POLYMER CONCRETE PATCHING MATERIAL. APPLY SUFFICIENT PRESSURE TO ASSURE PATCHING CONCRETE WILL FILL ALL VOIDS.

(F) 55 REPAIR FOR VERTICAL CRACKS IN PILE ABOVE WATER

GRAPHIC SCALES		OCEAN BEACH PIER REHABILITATION	
		SAN DIEGO CALIFORNIA	
		TYPICAL REPAIRS	
		SHT. NO. 55	
CITY OF SAN DIEGO, CALIFORNIA		W.O. NO. 118963	
ENGINEERING DEPARTMENT		DESIGN ENGINEER	
SHEET 55 OF 63 SHEETS		DATE	
DESCRIPTION		BY	APPROVED
ORIGINAL		DATE	FILED
CONTROL CERTIFICATION		DATE	
AS-BUILT		DATE	
CONTRACTOR: RESISTANCE CORP.		DATE STARTED: 10-31-1990	
INSPECTOR: D.S. SHAWWORTH		DATE COMPLETED: 1-11-1991	
		25002-55-D	

F FERVER ENGINEERING COMPANY
SAN DIEGO, CALIFORNIA

AS-BUILT

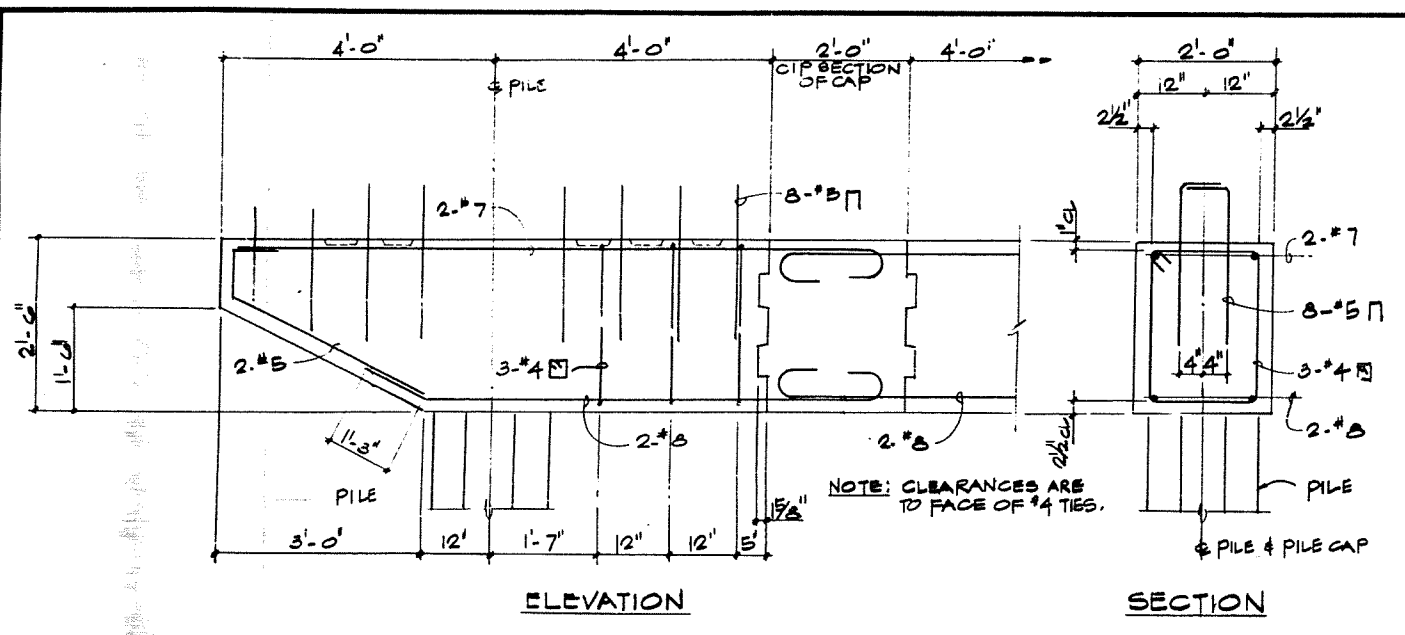

A
56
EXISTING PILE CAP - DIMENSIONS AND REINFORCING
PER AS-BUILT DRAWINGS OF ORIGINAL PIER 3/4" = 1'-0"

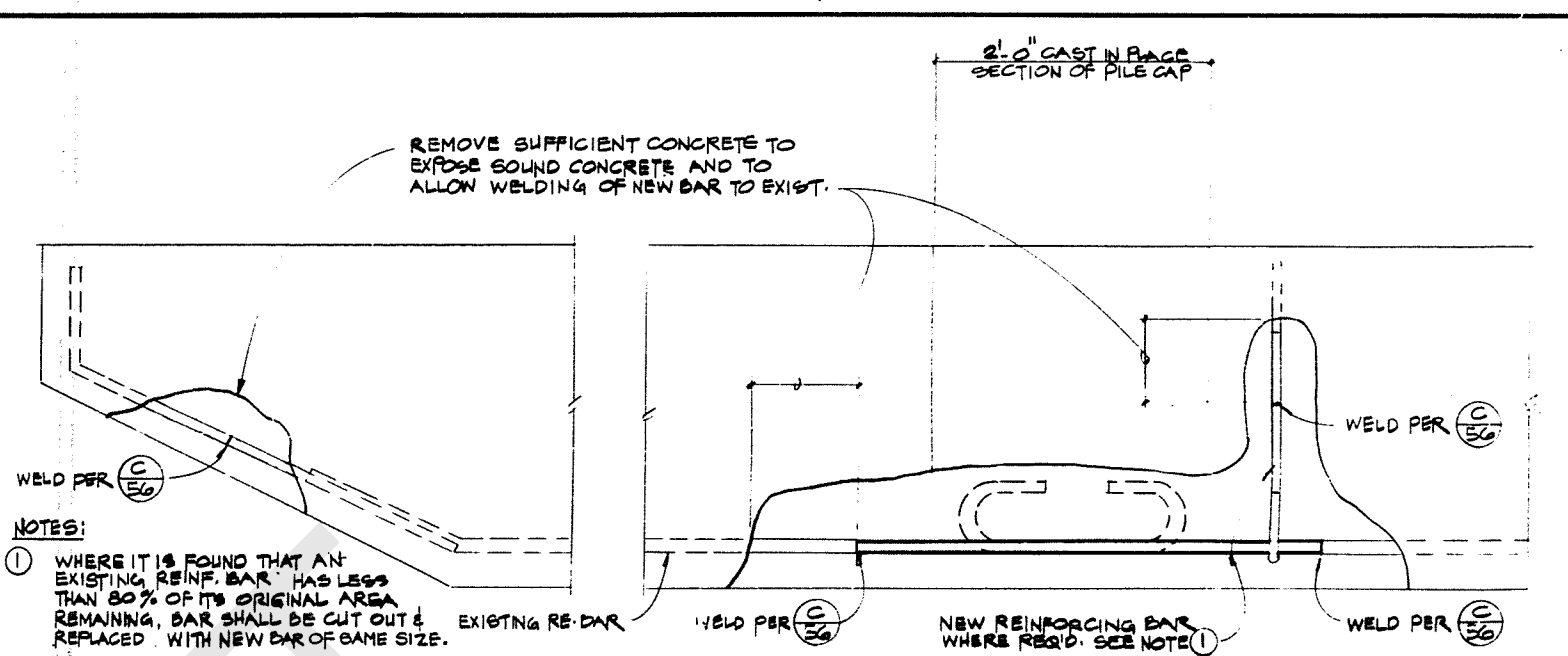

- NOTES:**
- WHERE IT IS FOUND THAT AN EXISTING REINF. BAR HAS LESS THAN 80% OF ITS ORIGINAL AREA REMAINING, BAR SHALL BE CUT OUT & REPLACED WITH NEW BAR OF SAME SIZE.
 - NEW BARS SHALL CONFORM TO ASTM A615 GRADE 60.

D
56
REPAIR FOR REINFORCING IN PILE CAPS

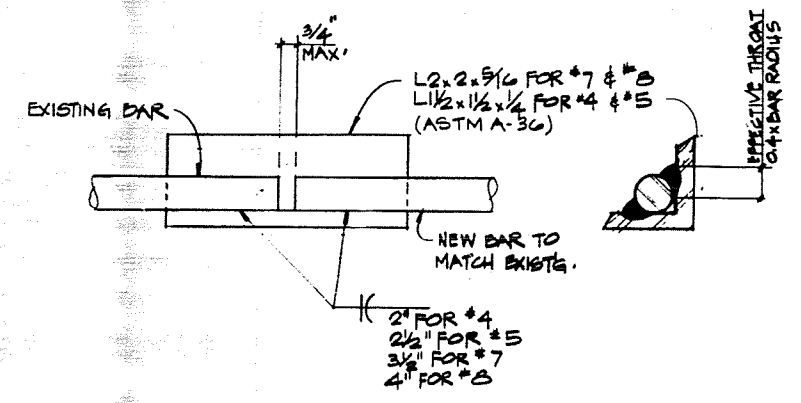

INDIRECT BUTT SPLICE

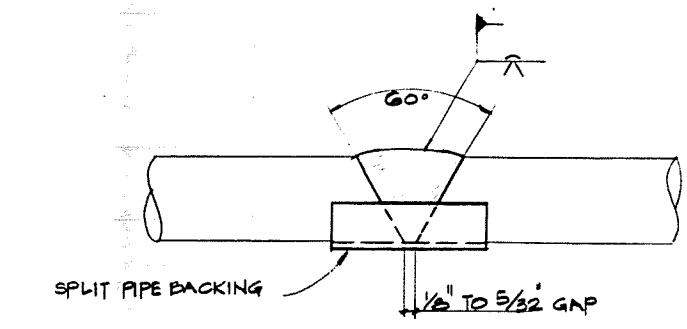

DIRECT BUTT SPLICE

C
56
REINFORCING WELDING DETAIL

- REQUIREMENTS FOR WELDING OF REINFORCING**
- ALL WELDING SHALL CONFORM TO AWS D14, STRUCTURAL WELDING CODE - REINFORCING STEEL.
 - THE CONTRACTOR SHALL EMPLOY THE SERVICES OF AN APPROVED TESTING LABORATORY TO PROVIDE THE INSPECTION OF ALL WELDING OF REINFORCING STEEL. THE TESTING LABORATORY SHALL REVIEW THE WELDING PROCEDURE, QUALIFICATIONS, WELDING PROCEDURE SPECIFICATIONS, AND WELDER QUALIFICATIONS.
 - UNLESS TESTS ARE MADE TO DETERMINE THE CHEMISTRY OF THE EXISTING AND NEW REINFORCING STEEL, ALL BARS SHALL BE PREHEATED TO 500 °F.
 - CONTINUOUS INSPECTION OF REINFORCING STEEL WELDING SHALL BE PROVIDED BY THE TESTING LABORATORY.

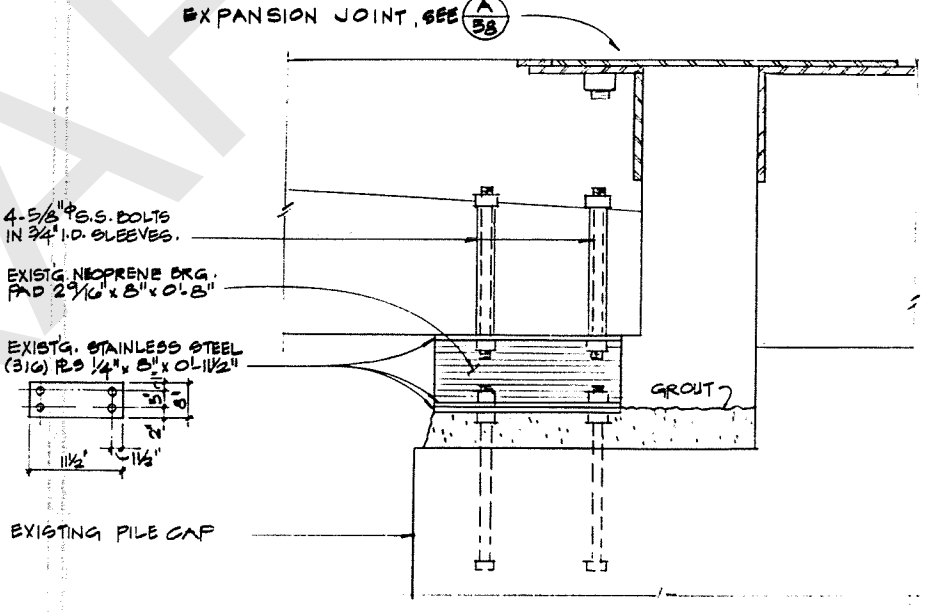

D
56
DETAIL OF EXISTING BEARING PADS AT EXPANSION JOINTS
3" = 1'-0"

- NOTES:**
- VERIFY ALL DIMENSIONS PRIOR TO FABRICATION OF NEOPRENE PADS OR RS.
 - WHERE EXISTING NEOPRENE PADS ARE MISSING OR DISPLACED, REPLACE WITH NEW PAD. CLEAN EXISTING RS OF ALL RUST AND FOREIGN MATERIAL AND CEMENT NEW PAD TO TOP AND BOTTOM RS.
 - WHERE EXISTING NEOPRENE PAD AND BOTTOM RS ARE MISSING, REPLACE PAD AND RS WITH NEW TO MATCH EXISTING. NEOPRENE TO HAVE A SHORE A DUREMETER OF 50.
 - SEE SHEETS 20 & 28 FOR LOCATION



GRAPHIC SCALES

3/4" = 1'-0" 0 6 1 2 3 4

3" = 1'-0" 0 3 6

Thomas L. Cook 5-15-89
THOMAS L. COOK DATE

FERVER ENGINEERING COMPANY
SAN DIEGO, CALIFORNIA

OCEAN BEACH PIER REHABILITATION SAN DIEGO, CALIFORNIA		SHT. NO. 56
REPAIR AND WELDING DETAILS		
CITY OF SAN DIEGO, CALIFORNIA ENGINEERING DEPARTMENT SHEET 56 OF 62 SHEETS		W.O. NO. 118963
<i>Thomas L. Cook</i> 5/15/89 DATE		<i>James Kenneth</i> DIVISION HEAD
DESCRIPTION	BY	APPROVED DATE FILMED
ORIGINAL		
CONTROL CERTIFICATION		
AS-BUILT	DATE 063 04/14	212-1689
CONTRACTOR: MARTINUS, C.H.S. DATE STARTED: 10-31-1989		LIBERTY CONSULTANTS
INSPECTOR: P. SCHWARTZ DATE COMPLETED: 1-13-1991		25002-56-D

AS-BUILT

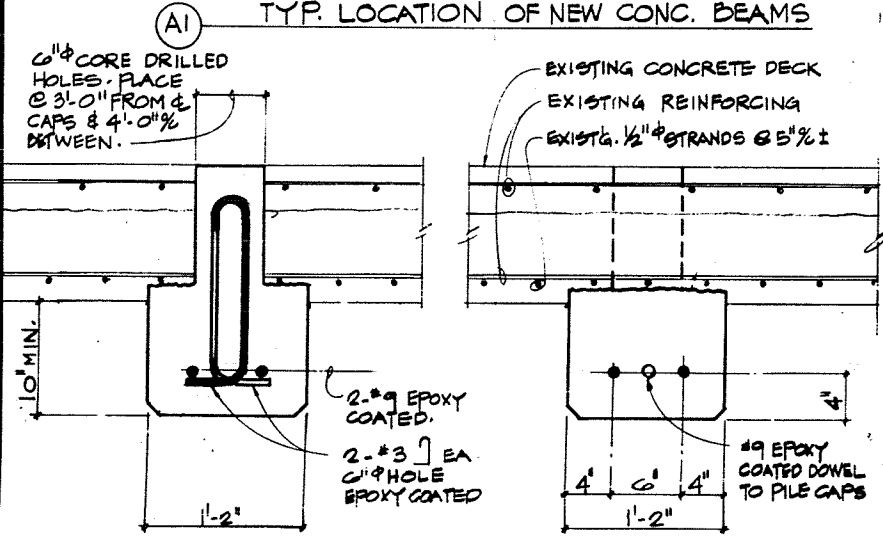
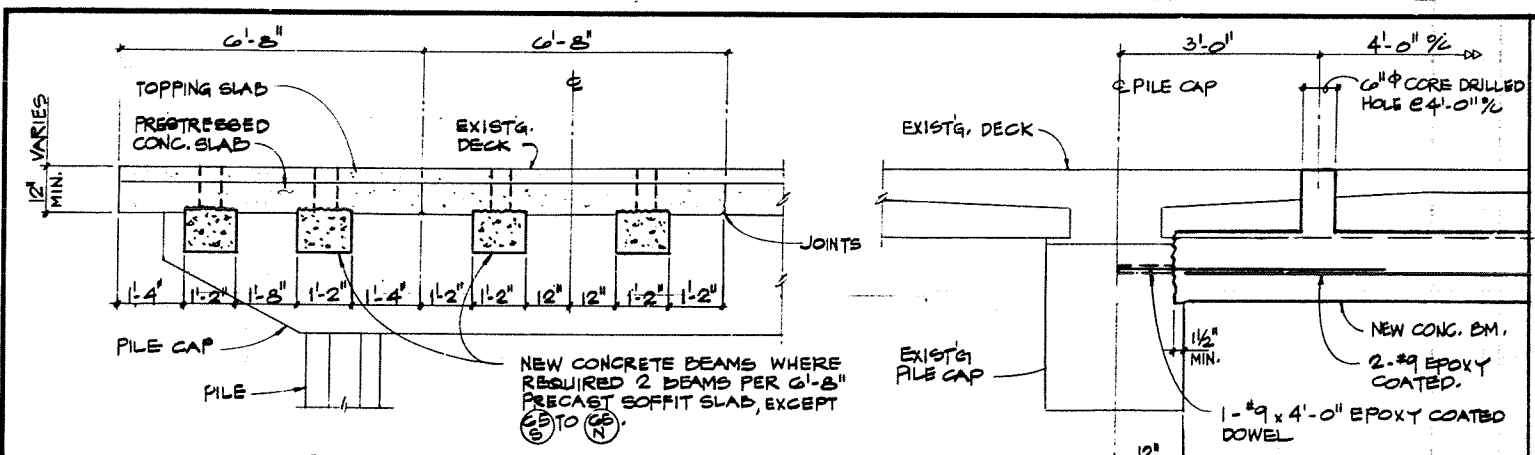

A1 TYP. LOCATION OF NEW CONC. BEAMS

A2 NEW CONC. BMS. BETWEEN PILE CAPS

② BEAMS SHOWN ON PLANS ARE AN ASSUMED NUMBER & LAYOUT. ACTUAL NUMBER OF BEAMS & LAYOUT SHALL BE DETERMINED IN FIELD BY CONDITIONS OF SOFFIT PANELS.

A 57

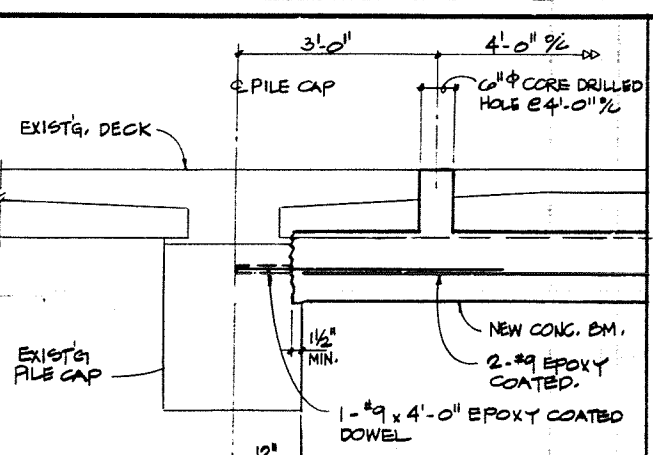

A3 CONN. OF NEW BM. TO EXIST. PILE CAPS

- NOTES FOR NEW CONCRETE BEAMS**
- REMOVE ALL DETERIORATED AND UNBOUND CONCRETE IN AREA OF NEW BEAMS TO SOUND CONCRETE.
 - SANDBLAST CONCRETE AND ALL PRESTRESSING STRANDS AND REINF. BARS IN AREA OF NEW BEAMS.
 - CHIP OUT SIDES OF EXISTING PILE CAPS FOR NEW BEAM SEATS.
 - DRILL 1 3/8" x 10" DEEP HOLES IN PILE CAPS AT CENTER OF NEW BEAMS FOR NEW #9 DOWELS. LOCATE EXIST. ST'U. IN CAP PRIOR TO DRILLING.
 - SET #9 EPOXY COATED DOWELS INTO PILE CAPS WITH SPECIFIED EPOXY GROUT.
 - CORE DRILL 6" HOLE @ 4'-0" thru exist'g. deck/soffit slab @ c. of new beams. LOCATE EXIST. ST'U. IN CAP PRIOR TO DRILLING.
 - INSTALL NEW REINF. IN BEAMS AND FORM BEAMS.
 - PLACE CONCRETE THRU 6" HOLES IN DECK & VIBRATE CONC.
 - AFTER FORM REMOVAL INJECT EPOXY CRACK REPAIR MATERIAL INTO JOINT BETWEEN NEW BEAM & EXIST'G. CONCRETE FROM EACH SIDE OF EACH BEAM. PORT HOLES TO BE 12" TO 18" OR AS REQUIRED TO INSURE COMPLETE BONDING OF NEW CONCRETE TO EXISTING.
 - AFTER FORMS ARE REMOVED, REPAIR REMAINING DECK SOFFIT PER DETAIL **B** 55.
 - APPLY SPECIFIED COATING TO ENTIRE DECK SOFFIT AND SURFACES OF NEW CONCRETE BEAMS.

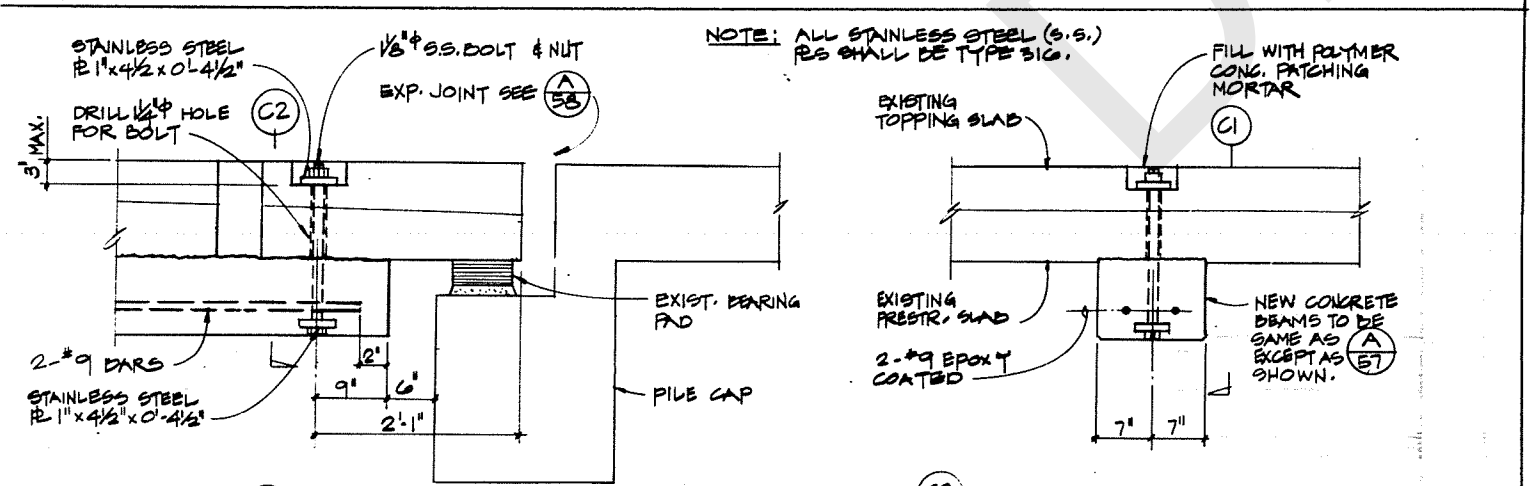

C1 SECTION

C 57



C2 SECTION

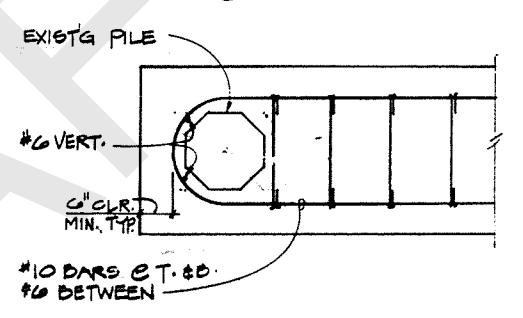
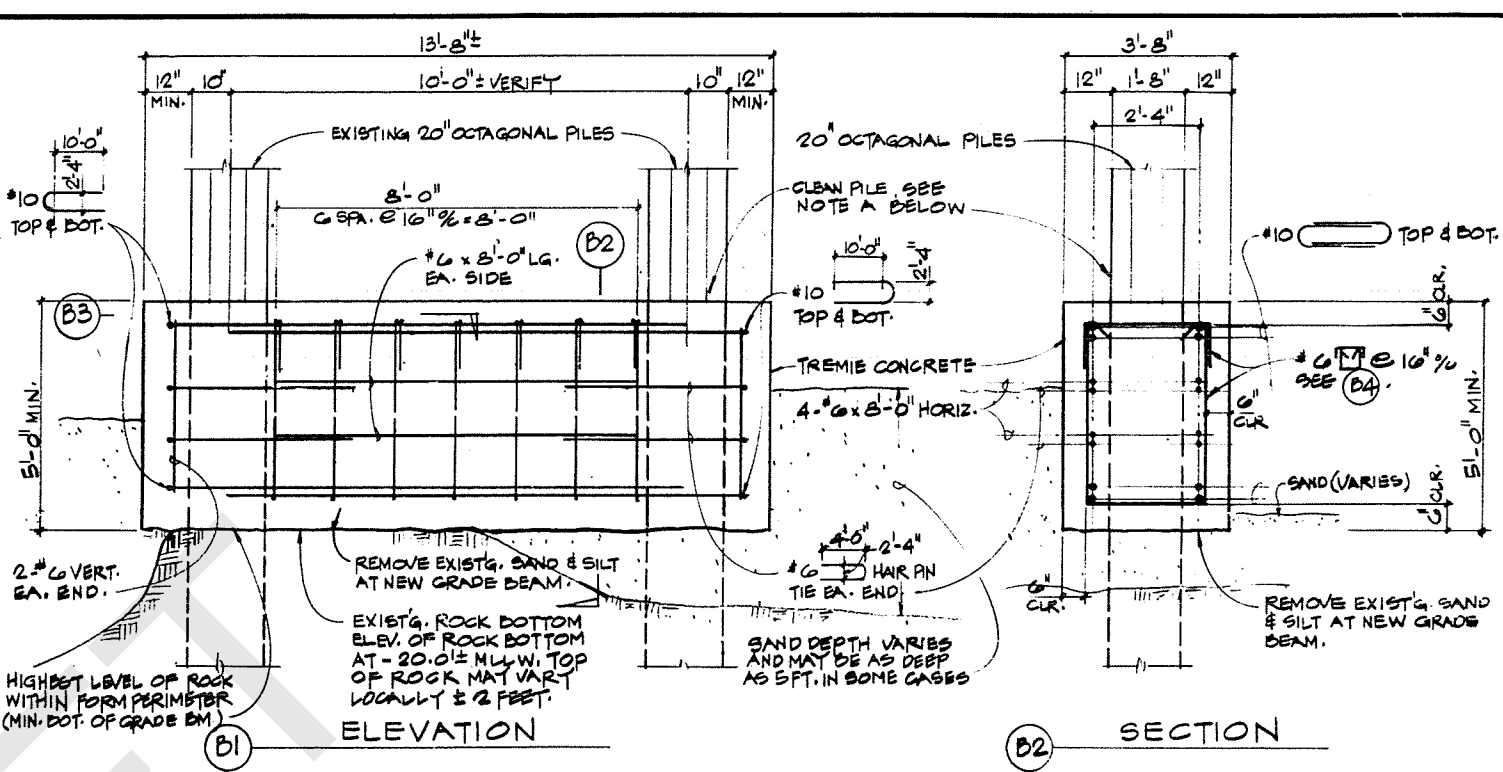

B3 PLAN SECTION

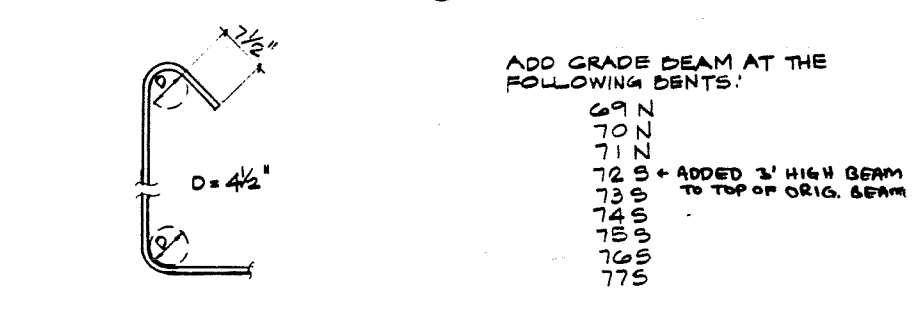

B4 TYP. STIRRUP BENDS

B 57

- NOTES:**
- MINIMUM BOTTOM OF GRADE BEAM SHALL BE THE HIGHEST LEVEL OF ROCK WITHIN THE PERIMETER OF THE GRADE BEAM.
 - REMOVE SAND AS NECESSARY TO SEAT FORM AT THE PROPER LEVEL.
 - REMOVE SAND FROM WITHIN FORM JUST PRIOR TO PLACING TREMIE CONCRETE

NOTE A: PROVIDE SANDBLASTING, WATERBLASTING AND OTHER METHODS TO PROVIDE A SUBSTRATA THAT IS CLEAN, SOUND AND FREE OF MARINE GROWTH. TO A MINIMUM OF 7 FEET ABOVE BOTTOM OF PILE. PATCH CRACKS, IF FOUND, ABOVE TOP OF GRADE BEAM PER DETAIL **F** 55.

ADD GRADE BEAM AT THE FOLLOWING BENTS:

69 N
70 N
71 N
72 S + ADDED 3' HIGH BEAM TO TOP OF ORIG. BEAM
73 S
74 S
75 S
76 S
77 S

FERVER ENGINEERING COMPANY
SAN DIEGO, CALIFORNIA

DATE: 5-15-89
DESIGNED BY: THOMAS L. COOK

OCEAN BEACH PIER REHABILITATION
SAN DIEGO, CALIFORNIA
TYPICAL PIER REPAIRS
SHT. NO. 57

CITY OF SAN DIEGO, CALIFORNIA
ENGINEERING DEPARTMENT
SHEETS 7 OF 63 SHEETS
W.O. NO. 118963

CONTRACTOR: MARCHETTI
DATE STARTED: 1-7-1991
INSPECTOR: D. SCHWARTZ
DATE COMPLETED: 1-19-1991

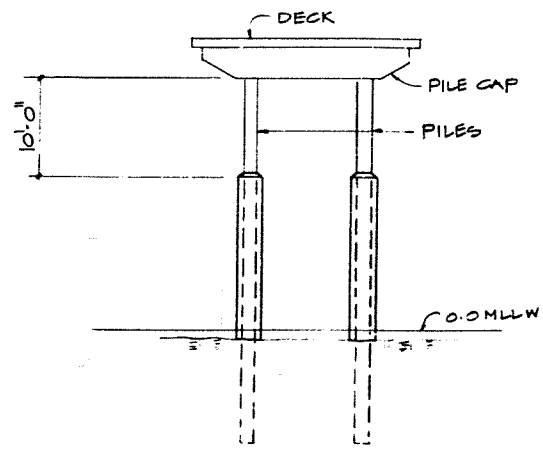

PIER SECTION
SCALE 1/8" = 1'-0"

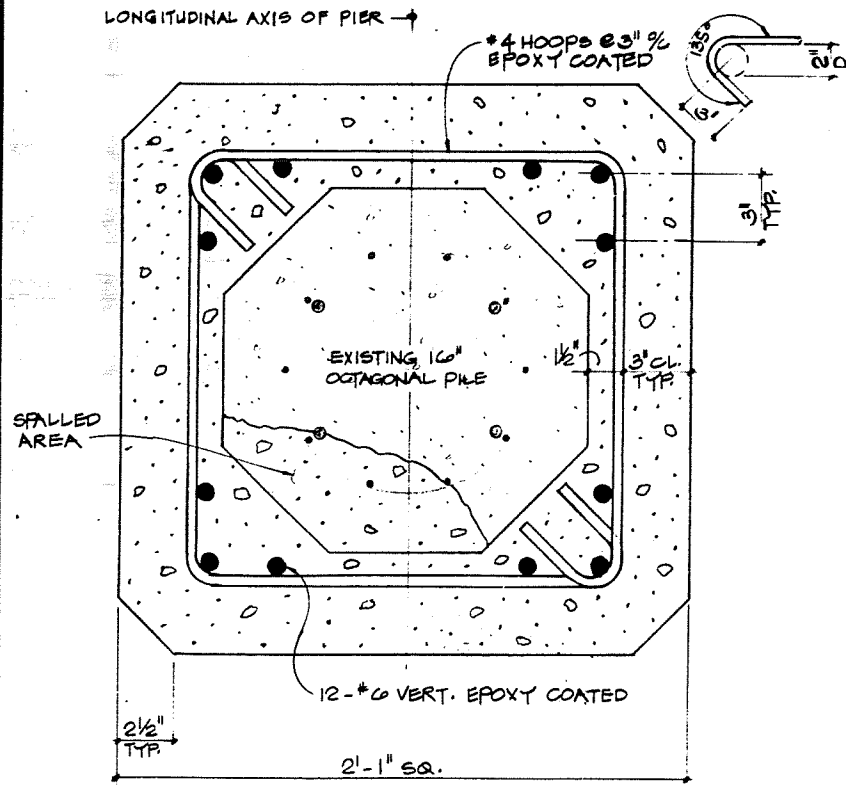

ALL TIE WIRES SHALL BE ANNEALED WIRE COATED WITH PLASTIC, EPOXY OR NYLON. BAR SUPPORTS SHALL BE PLASTIC.

A PLAN SECTION
3" = 1'-0"
TYPICAL

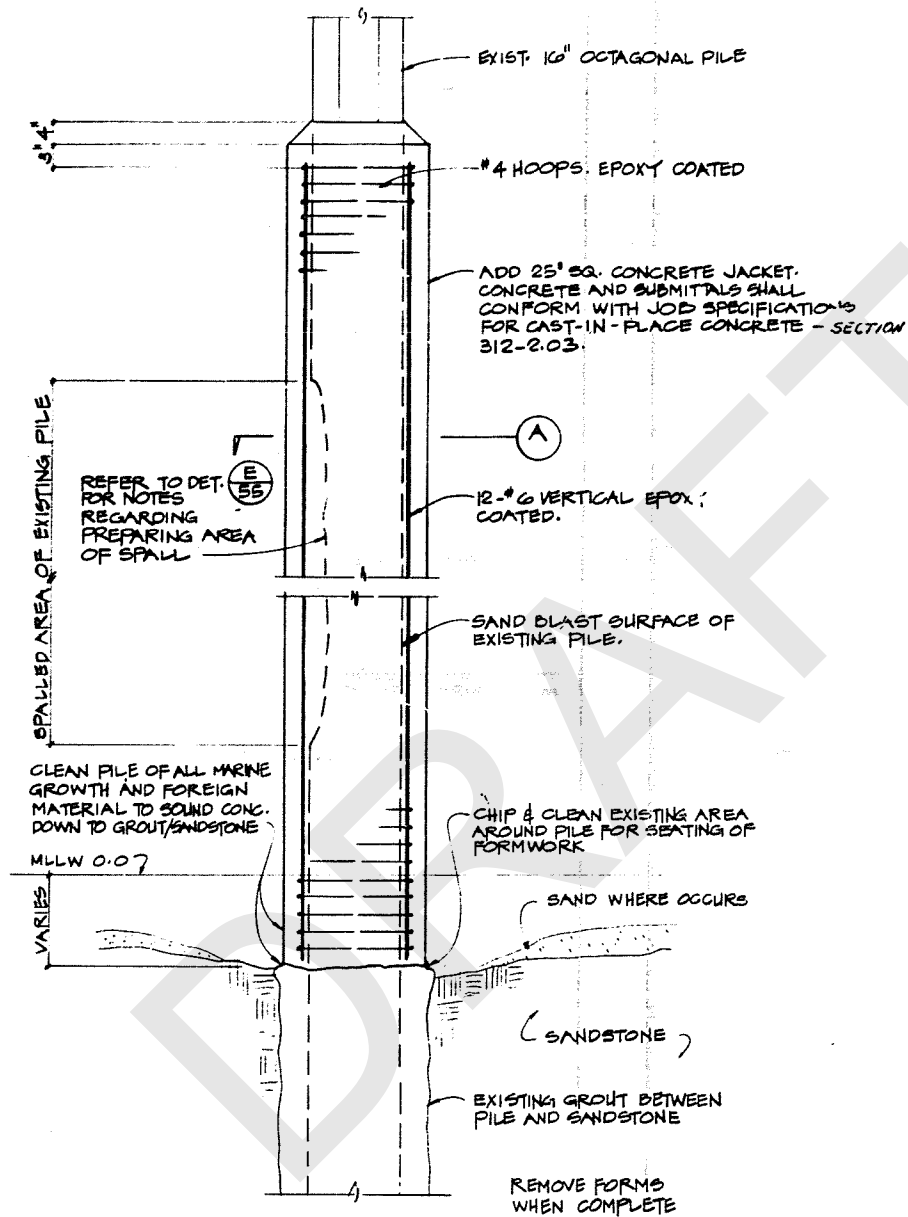

PILE JACKETING DETAIL
3/4" = 1'-0"

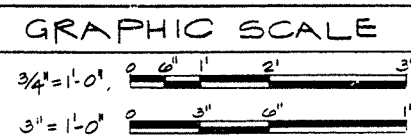

OCEAN BEACH PIER REHABILITATION SAN DIEGO, CALIFORNIA		SHT. NO. 63
FILE JACKETING REPAIR DETAIL		
CITY OF SAN DIEGO, CALIFORNIA ENGINEERING DEPARTMENT SHEET 63 OF 63 SHEETS	W.O. NO. 118963	
FOR CITY ENGINEER	DATE 5-8-90	DESIGNED BY R.S. Cook
DESCRIPTION	BY	APPROVED DATE FILMED
ORIGINAL		
AS-BUILT	BAG, D.E.J.	8/2/01
CONTRACTOR	DATE STARTED	10-31-1997
INSPECTOR	DATE COMPLETED	1-14-1997
FERVER ENGINEERING COMPANY SAN DIEGO, CALIFORNIA		212-1689 25002-63-D

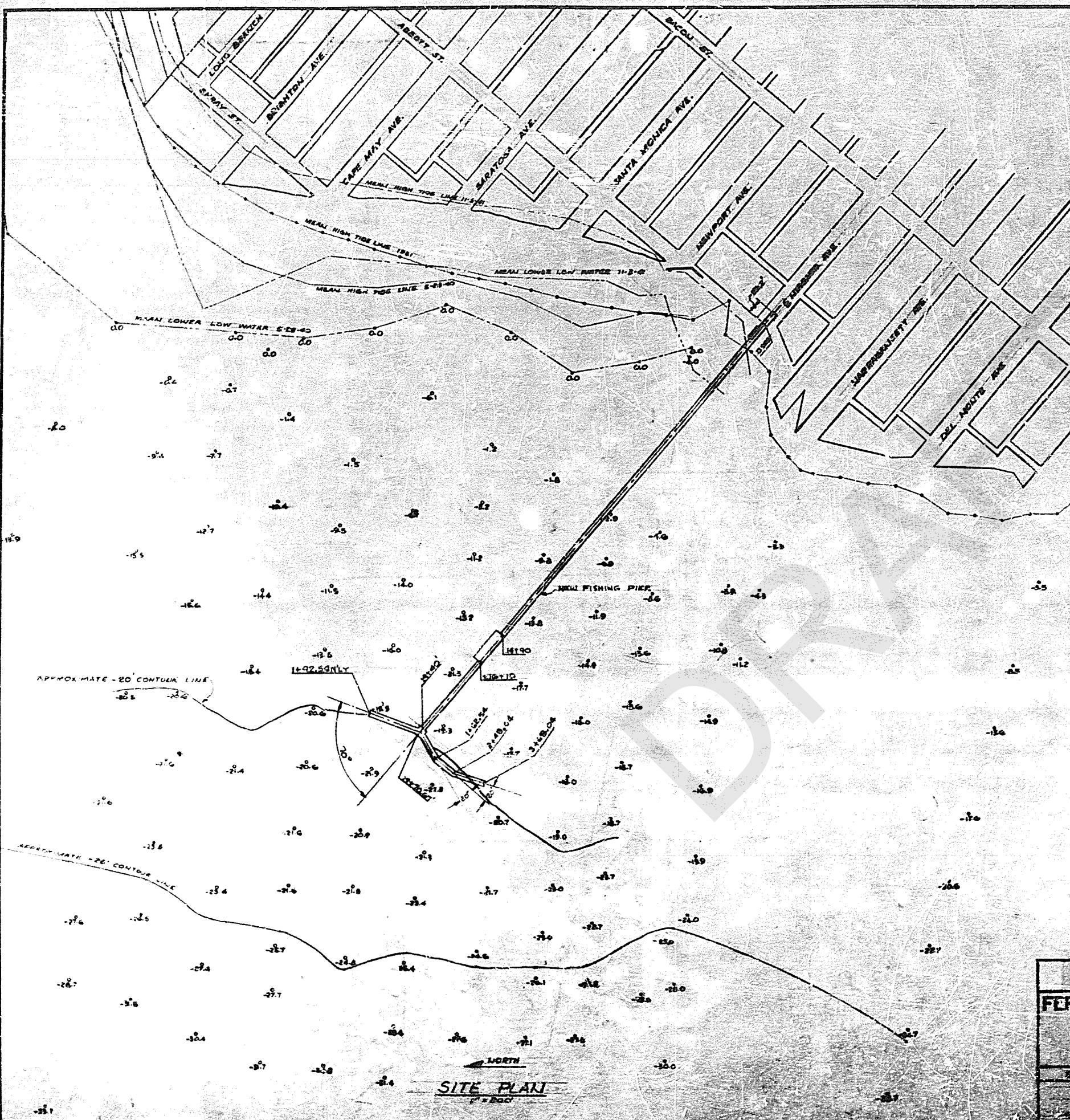

NOTES:

1. SITE PLAN INFORMATION, INCLUDING FOUNDATIONS, IS BASED UPON DATA TAKEN FROM CITY OF SAN DIEGO ENGINEERING DEPT. DRAWING TITLED "SOUNDING OF PACIFIC OCEAN BETWEEN POINT LOMA BATTERY & LORAIN STREET & VICINITY PORTION OF MISSION BAY DISTRICT WEST FROM LOMA BATTERY SAN PETER'S PLACE" AND DATED JULY 31, 1952.
2. ALL ELEVATIONS SHOWN ARE BASED ON TIDE G. S. DATUM.
3. PIER CONSTRUCTION SHOWN THIS SHEET IS FOR BASE AND SEE SHEET NO. FOR ADDITIVE OR "PROJECT" OR "ALTERNATE".

WORK TO BE DONE:

WORK TO BE DONE CONSISTS OF CONSTRUCTING THE OCEAN BEACH PIER IN THE CITY OF SAN DIEGO ACCORDING TO THESE PLANS AND THE SPECIFICATIONS HERETO ATTACHED.

SPECIFICATIONS:

STANDARD SPECIFICATIONS OF THE CITY OF SAN DIEGO AS FOLLOWS:

- PART I, FILED APRIL 9, 1958, INCLUDING AMENDMENTS TO PART I, FILED APRIL 8, 1959 AND NOVEMBER 29, 1962.
- PART I, SECTION 1, GENERAL CONDITIONS, FILED OCTOBER 26, 1961.
- PART II, FILED 10-1-54, REVISED 1-1-58.
- PART III, FILED 5-1-55.
- PART IV, FILED 5-9-58.

SPECIAL SPECIFICATION NO. 1019

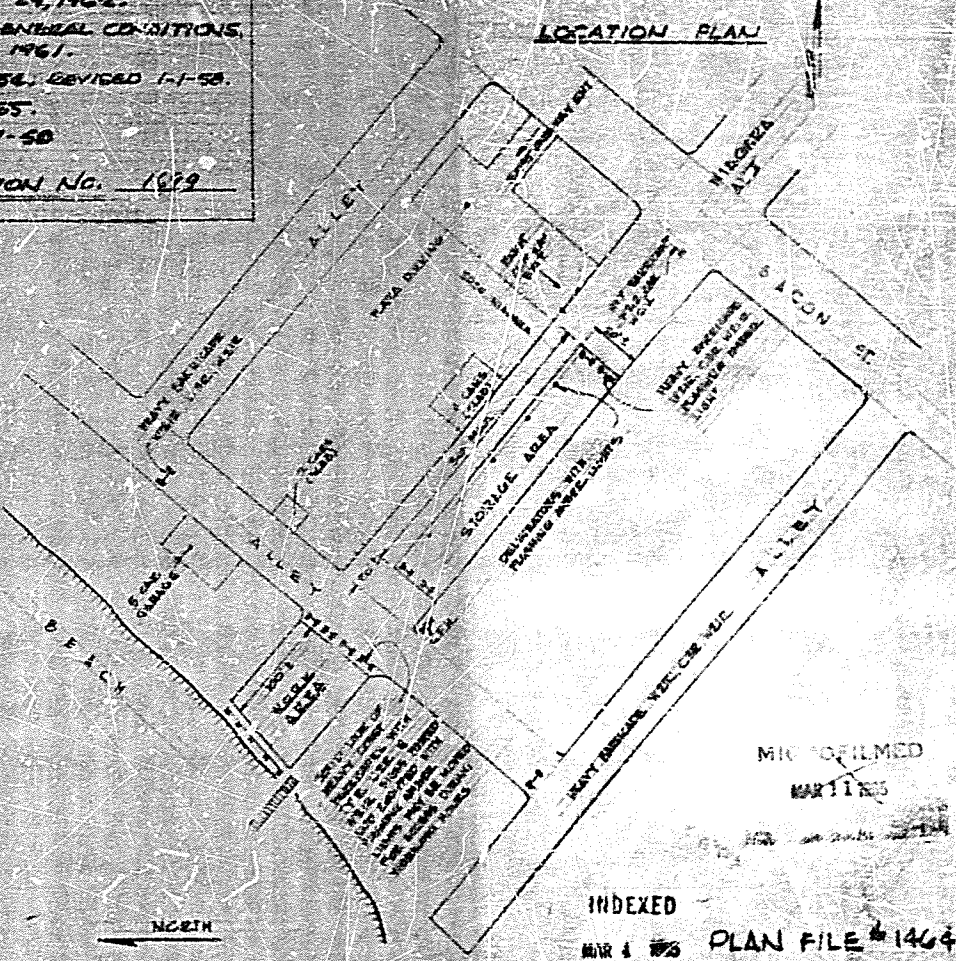
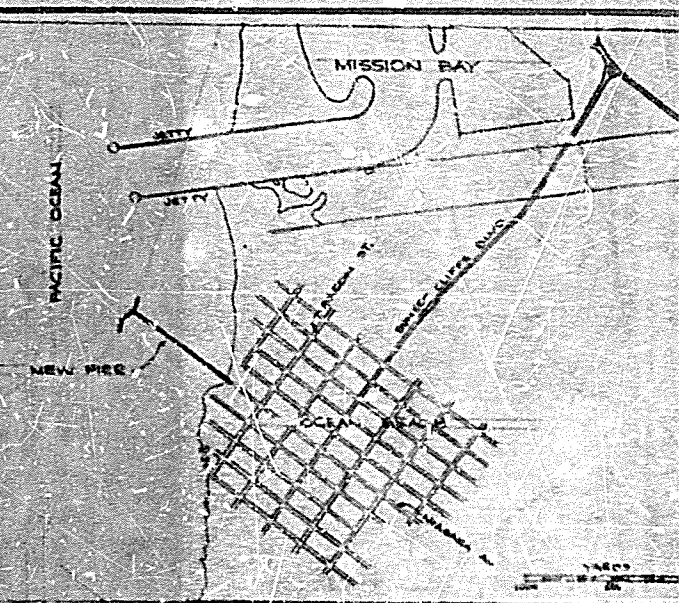

SITE PLAN
1" = 800'

LYKOS & GOLDHAMMER
ARCHITECTS & ENGINEERS

FERVER-DORLAND & ASSOCIATES

STRUCTURAL ENGINEERS

SAN DIEGO CALIFORNIA

A JOINT VENTURE

OCEAN BEACH FISHING PIER		CITY OF SAN DIEGO	
ENGINEERING DEPARTMENT		SHEET 1 OF 31 SHEETS	
DESIGNED BY	DATE	APPROVED BY	DATE
AS BUILT	1-21-54	VPC	1-21-54
CONTRACT NO.	1-21-54	PROJECT NO.	1464
SCALE	1" = 800'	DATE	1-21-54

INDEXED
MAY 4 1955
PLAN FILE # 1464
CITY CONTRACT

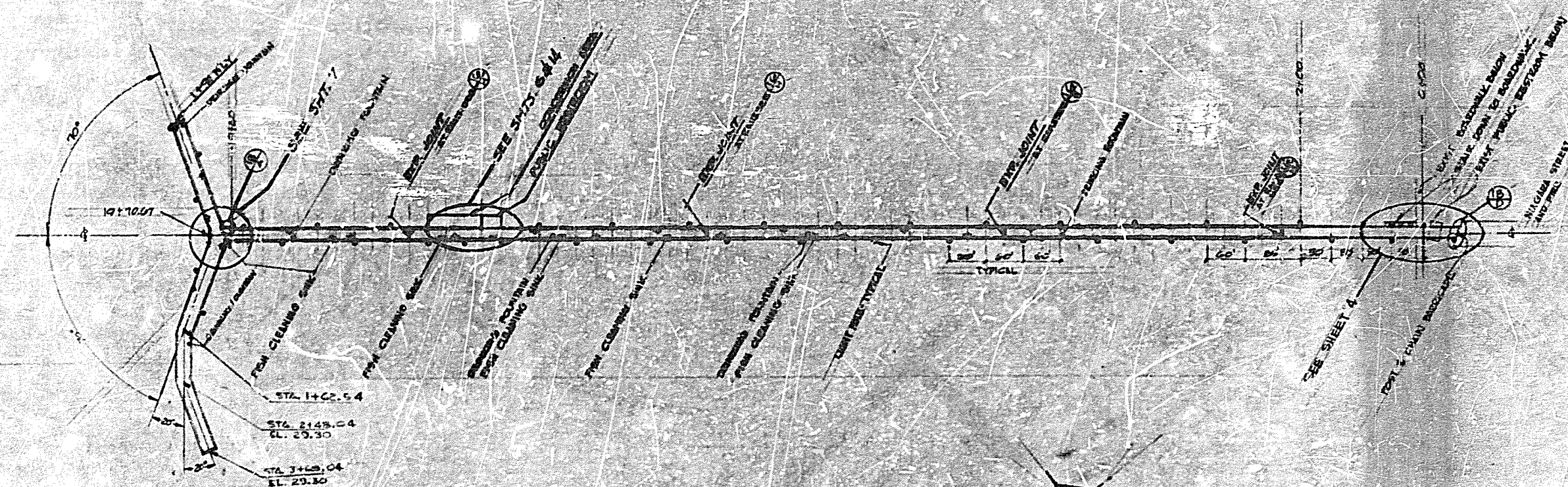

PLAN OF FISHING PIER
 SCALE: 1"=100'
 (CASE BID SHOWN)



LEGEND

- LIGHT POLE (40) POLES
- ◻ FISH CLEANING SINK (6)
- DRINKING FOUNTAIN (2)
- ⊙ SEE SHEET 18 FOR LOCATION OF HOSE BIBBS
- ◆ BENCHES @ 100' o.c. (19 PLACES) SEE DETAIL

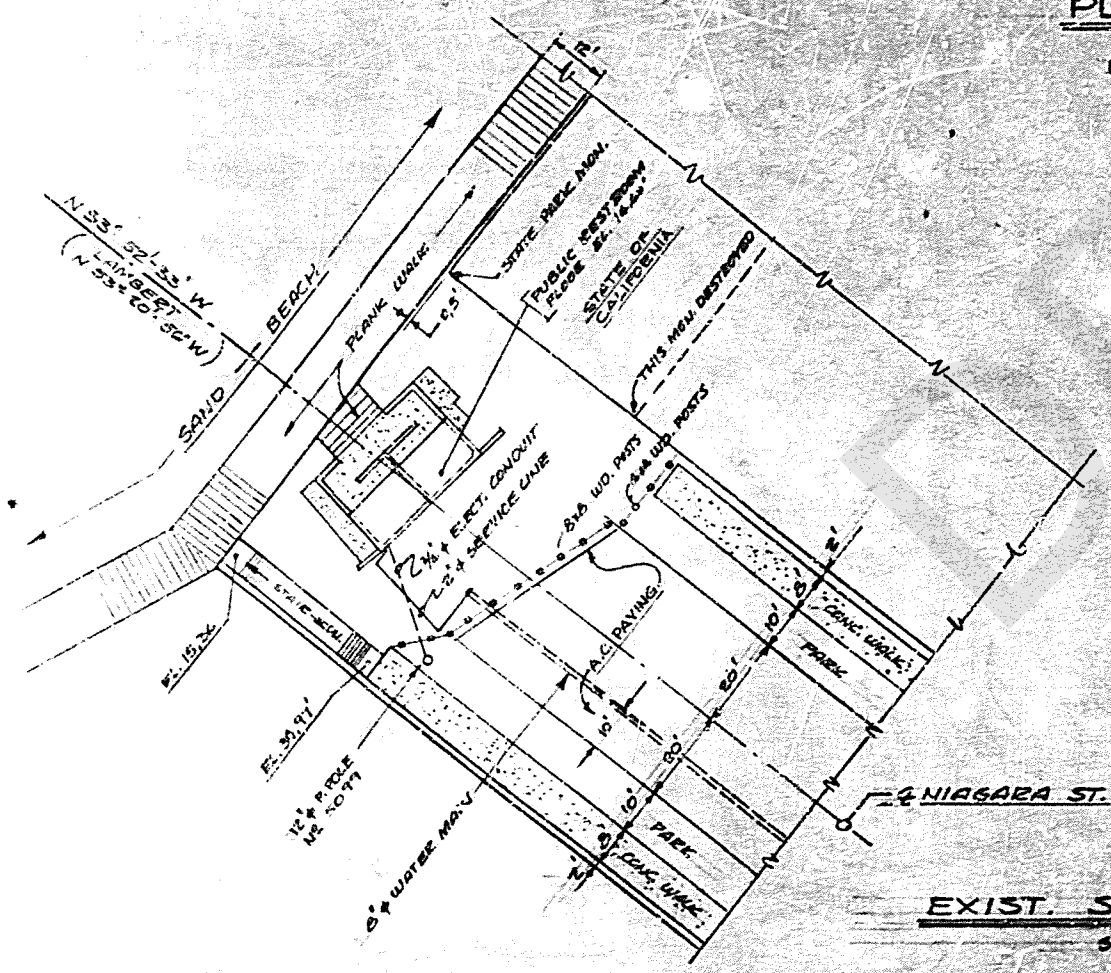

EXIST. SITE PLAN
 SCALE: 1"=20'



INDEXED
 MAR 1 1965

LYKOS & GOLDRAMMER ARCHITECTS & ENGINEERS FERVER-DORLAND & ASSOCIATES STRUCTURAL ENGINEERS SAN DIEGO CALIFORNIA A JOINT VENTURE SIGNED: <i>[Signature]</i>		OCEAN BEACH FISHING PIER CITY OF SAN DIEGO & STATE WILDLIFE CONSERVATION BOARD CITY OF SAN DIEGO ENGINEERING DEPARTMENT SHEET 2 OF 31 SHEETS NO. 17467	
		PLAN SECTION AS BUILT DATE: 6-9-64 APPROVAL: <i>[Signature]</i> DATE: 7-2-65	APPROVAL: <i>[Signature]</i> DATE: 7-2-65

MICROFILM AS BUILT

NOTE: Deck line elevations are to top of nominal 4" cast-in-place topping slab.

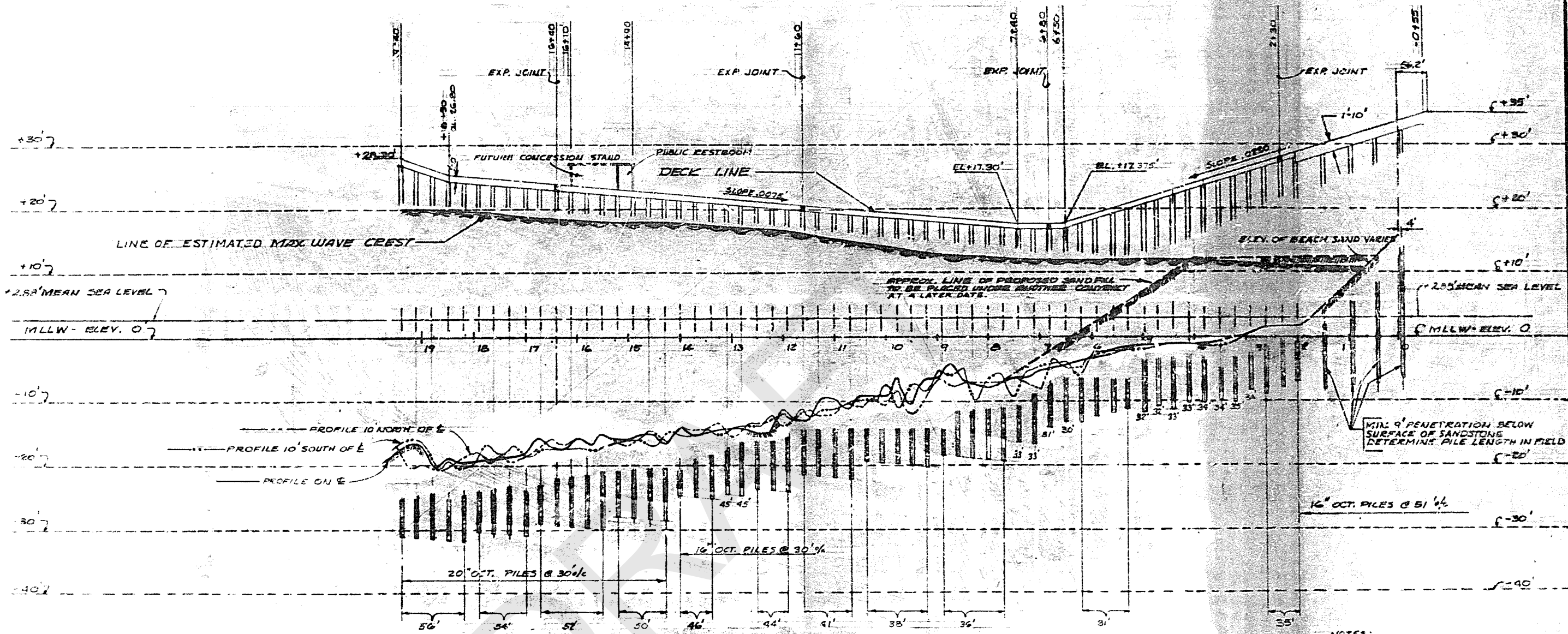

PROFILE ON ϕ OF PIER

SCALE: 1" = 100' HORIZ.
1/4" = 10' VERT.

NOTE:
Pile lengths shown are based on desired minimum penetration below surface of sandstone bottom. Location of sandstone surface has been estimated from fathometer soundings taken by City of San Diego. See Dwg. 1834-D
Minimum penetrations below surface of sandstone at pile location shall be:
(a) 20" piles - 11'-0"
(b) 16" piles - 9'-0"
At his option Contractor may install piles to greater penetration or Contractor may elect to otherwise vary lengths of piles from those shown, provided minimum penetration requirements are satisfied.

NOTES:
1. AT STA. 0 + 91.5, SANDSTONE SURFACE IS ELEVATION 0.0
2. ALL ELEVATIONS SHOWN ARE BASED ON U.S.C. & G.S. DATUM.

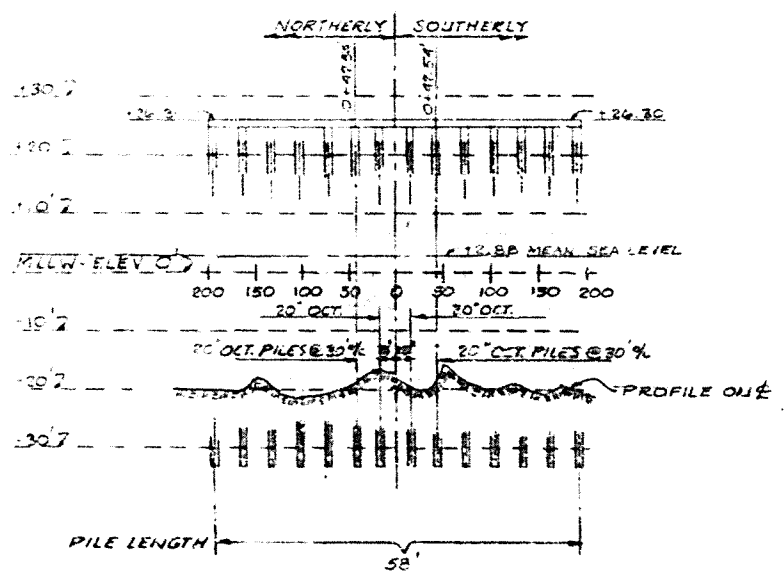

PROFILE ON ϕ OF PIER AT END INTERSECTION

SCALE: 1" = 100' HORIZ. 1/4" = 10' VERT.

LYKOS & GOLDHAMMER ARCHITECTS & ENGINEERS
FERVER-DORLAND & ASSOCIATES
STRUCTURAL ENGINEERS
 SAN DIEGO CALIFORNIA
 A JOINT VENTURE
 SIGNED: *[Signatures]*

PROFILE ON ϕ OF PIER
OCEAN BEACH FISHING PIER
 FOR
CITY OF SAN DIEGO & STATE WILDLIFE CONSERVATION BOARD

CITY OF SAN DIEGO
 ENGINEERING DEPARTMENT
 SHEET 3 OF 31 SHEETS
 NO. 17467

CHANGE	NO.	DATE	APPROVAL	BY
AS BUILT	1	12/1/45	DVC	[Signature]

DESIGNED BY: [Signature]
 CHECKED BY: [Signature]
 DRAWN BY: [Signature]
 FIELD REP: [Signature]

INDEXED
MAR 4 1955

NOTE: Deck line elevations are to top of nominal 4" cast-in-place topping slab

SEE SHEET 26 FOR PLATFORM

SEE ARCH. PLAN

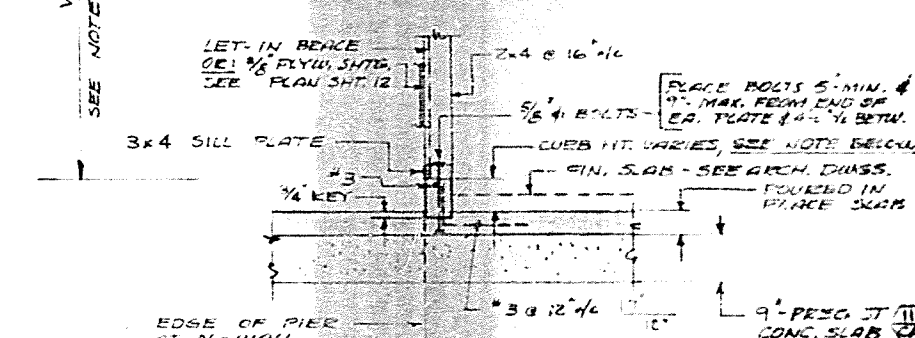
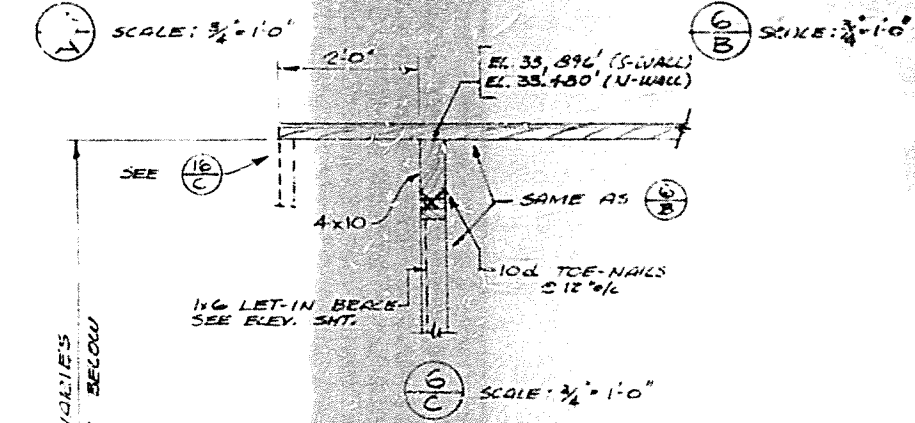
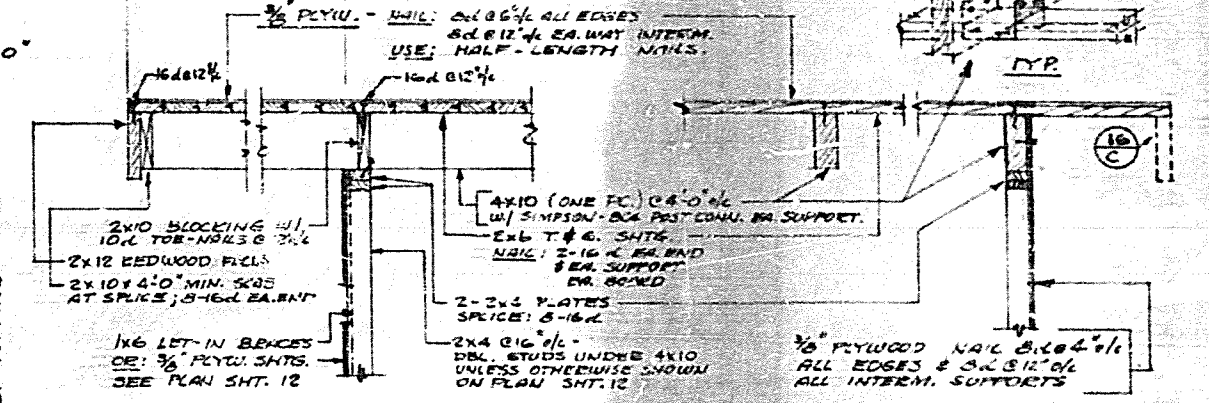
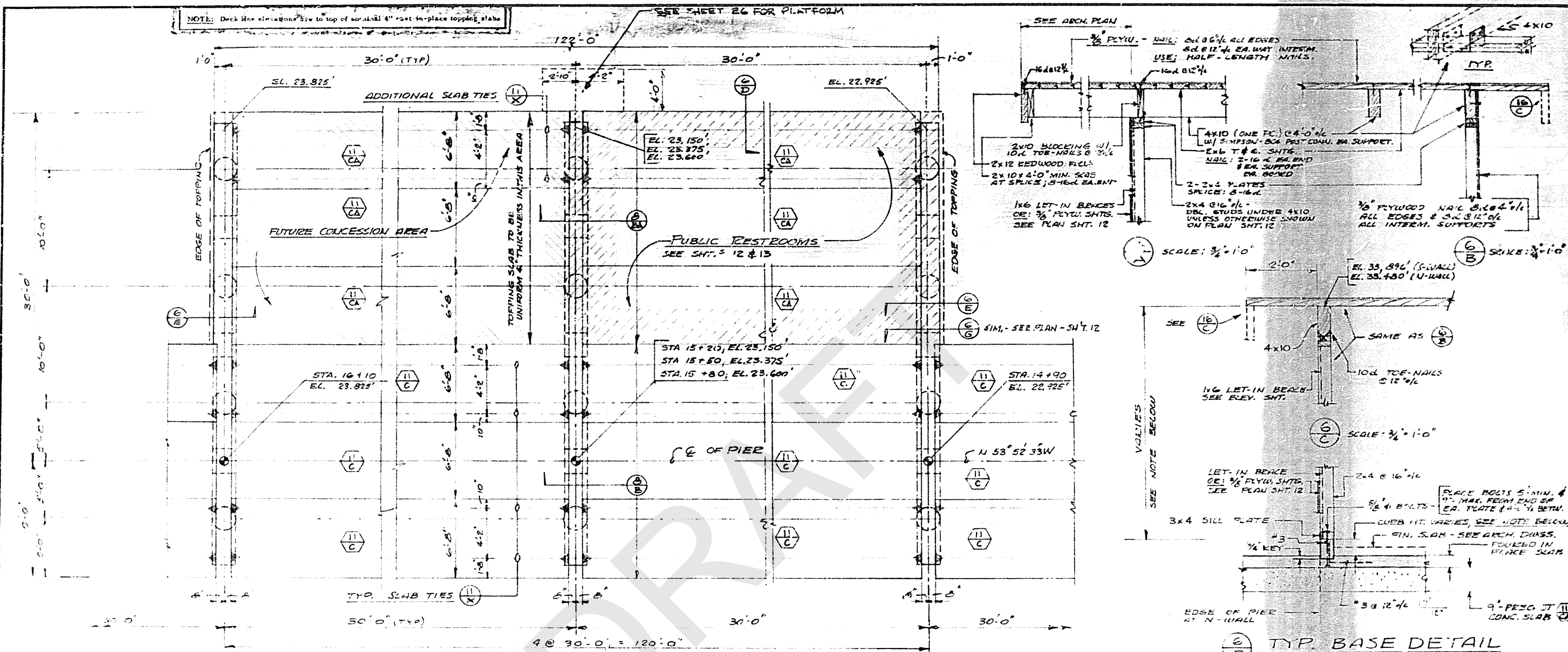

PLAN OF PIER AT PUBLIC RESTROOMS
SCALE: 1/4" = 1'-0"
(TOPPING OMITTED FOR CLARITY)

(II) INDICATES SLAB DET. - SEE SHT. 11

CURB NOTES: 1) TOP OF CURBS TO BE LEVEL. 2) PROVIDE STEPS AS REQ'D TO MAINTAIN 3" MIN. & 6" MAX. CURB HEIGHT.

(B/F) TYP. NAILING SCHEDULE

CONNECTION		
JOISTS TO BEARING - TOE NAIL EA. SIDE	---	2-10d
JOISTS TO SIDES OF STUDS	---	3-16d
JOISTS TO EDGE OF STUDS	---	2-16d
STUDS TO BEARING	---	2-10d
BLOCKING BETWEEN JOISTS - TOE NAIL EA. SIDE EA. END	---	2-10d
HERRINGBONE BLOCKING EACH END	---	2-10d
WOOD CROSS BRIDGING - TOE NAIL EA. END	---	7-8d
PLYWOOD SHEATHING - BEARING EDGES	---	8d @ 6"
INTERMEDIATE BEARINGS	---	8d @ 12"
TOP PLATES - SPIKE TOGETHER	---	16d @ 12"
LAPS & INTERSECTIONS	---	2-16d
PLATF (LOWER) TO STUDS	---	2-16d

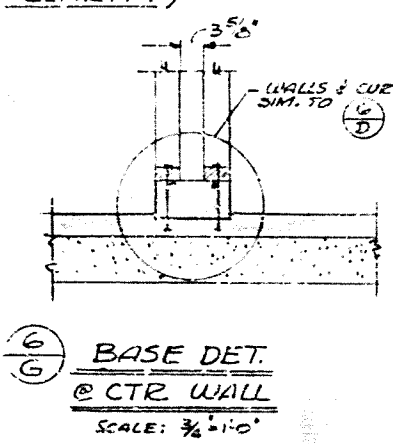

(G) BASE DET. @ CTR. WALL
SCALE: 3/4" = 1'-0"

LYKOS & GOLDHAMMER ARCHITECTS & ENGINEERS
FERVER-DORLAND & ASSOCIATES
STRUCTURAL ENGINEERS
SAN DIEGO CALIFORNIA
A JOINT VENTURE
SIGNED [Signatures]

PLAN AT STA. 14+90 TO 16+10
OCEAN BEACH FISHING PIER
FOR THE CITY OF SAN DIEGO & STATE WILDLIFE CONSERVATION BOARD

CITY OF SAN DIEGO ENGINEERING DEPARTMENT		SHEET 6 OF 31 SHEETS		NO. 17467
DESIGNED BY	DATE	APPROVED BY	DATE	
65 BULL	6-30-66	[Signature]	7-2-66	
CHECKED BY	DATE	APPROVED BY	DATE	
[Signature]		[Signature]		
CONTRACT NO.	7-2-66	PROJECT NO.		
DATE DRAWN		SCALE		
FIELD BOOK		PROJECT		

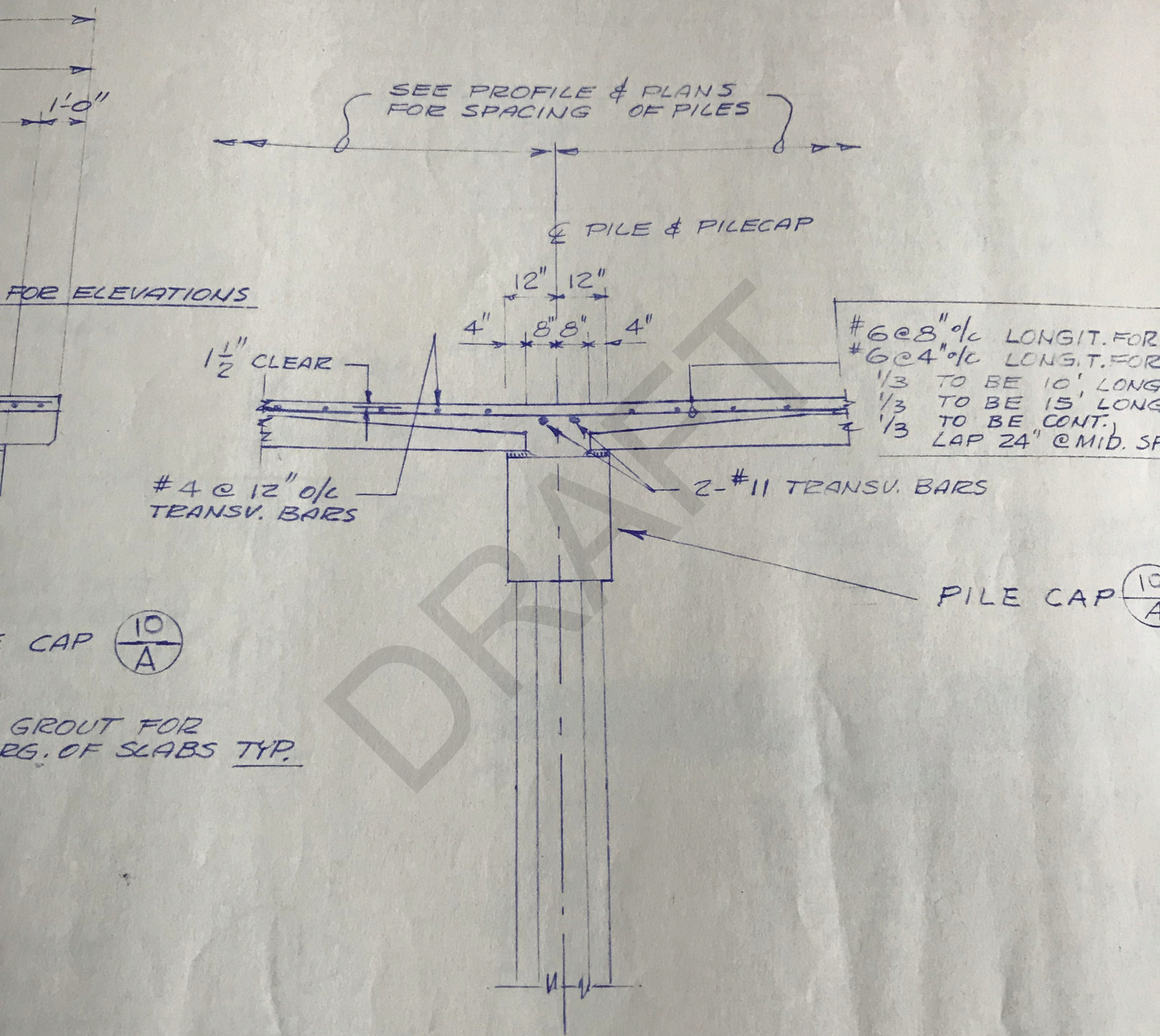

TYP. SLAB JOINT

SCALE: 3/8" = 1'-0"

NOTE: 1) ALL ANCHORS ARE RESISTANT STUDS, 1/2" DIAM. LENGTH AS SHOWN SPACED 8" OC UNLESS NOTED
 2) ROLL 1/2" REINFORCING CHANNELS & SPACING FURNISH 1/2" FROM 4" TO 11" LENGTHS SET IN W.P. GRAPHITE GREASE

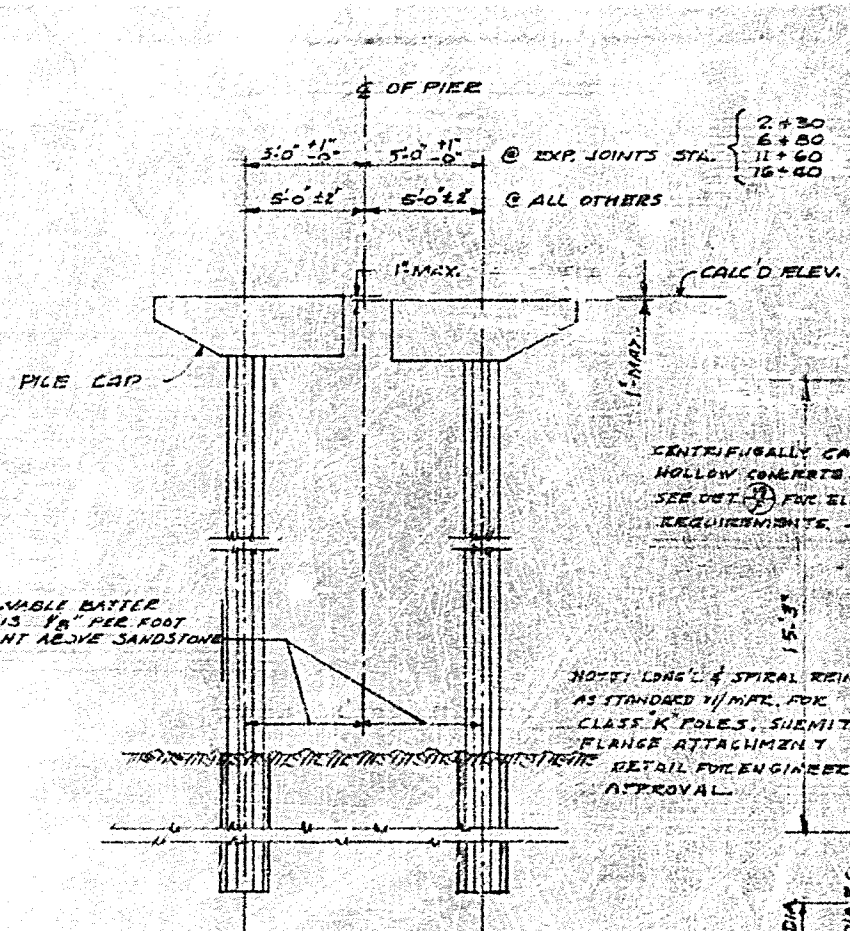

PIER SECTION
 SHOWING PLACING TOLERANCES
 SCALE: 1/4" = 1'-0"

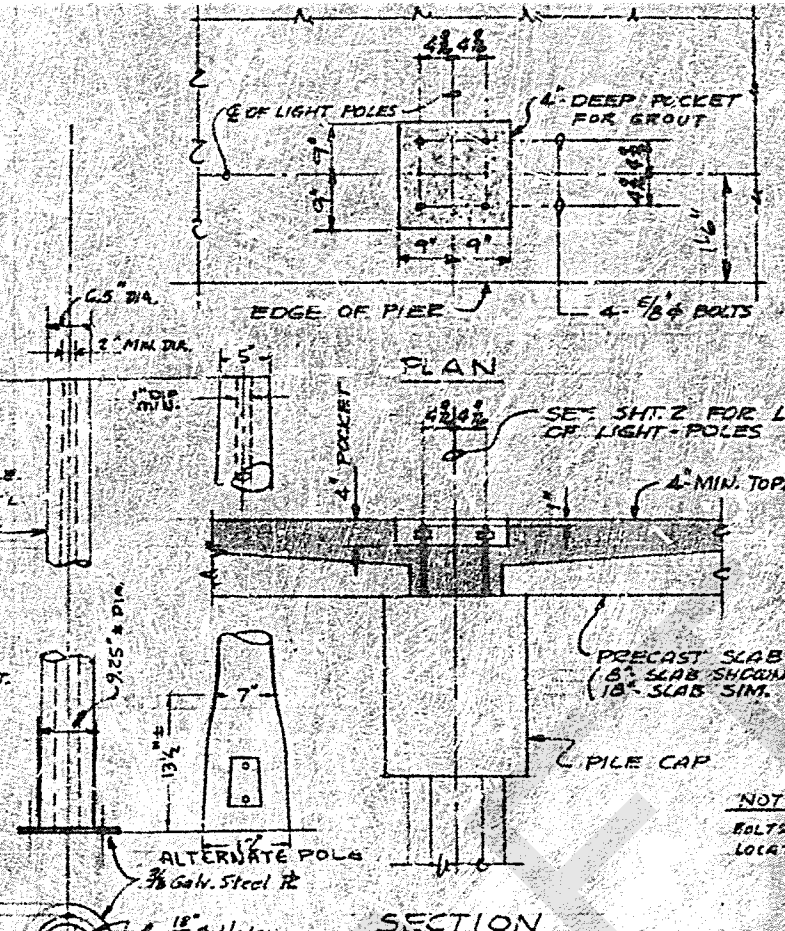

LIGHT-POLE BASE DETAIL
 SCALE: 3/4" = 1'-0"

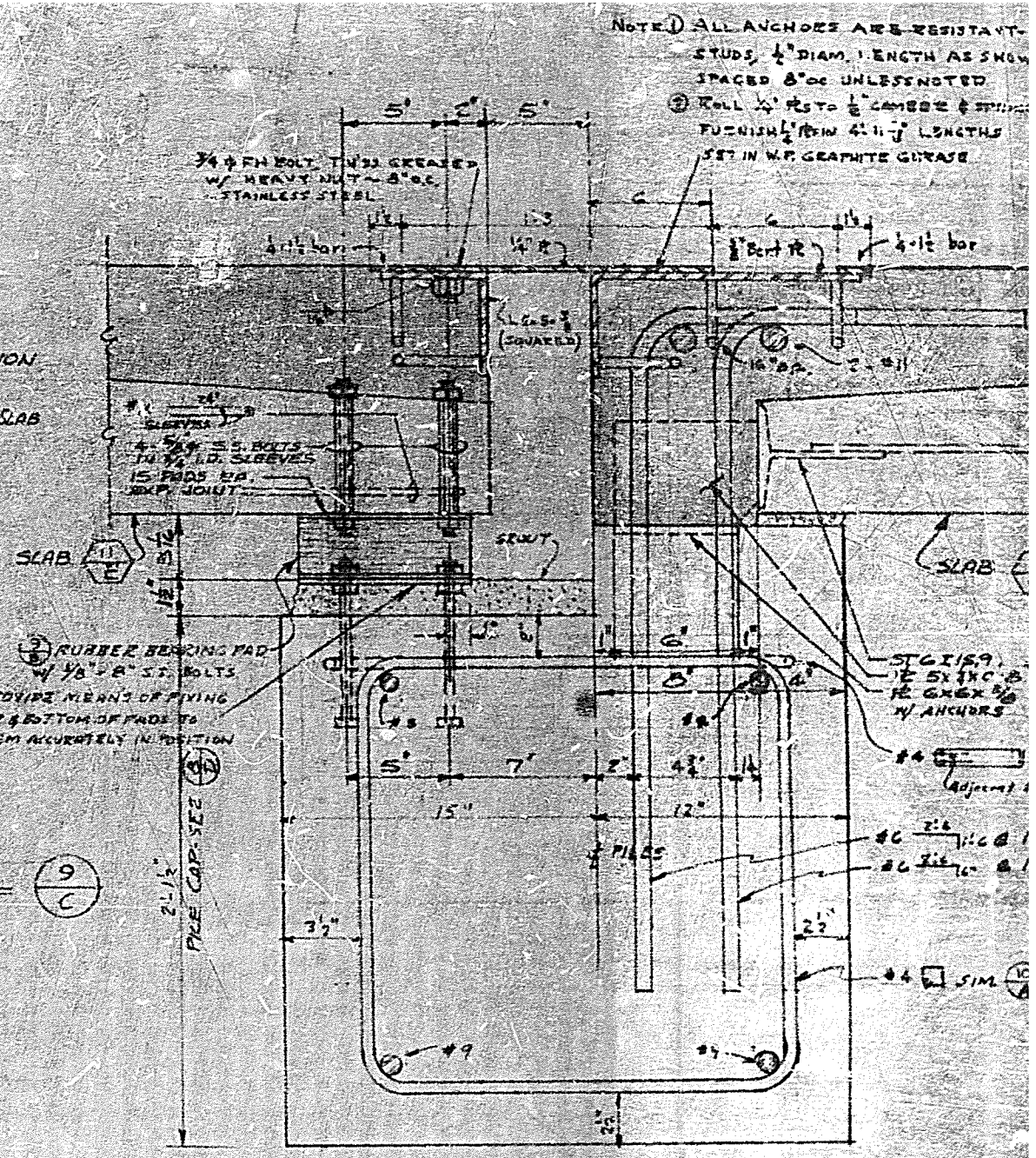

SECT. THRU PILE CAP @ EXPANSION JT. - TYP.

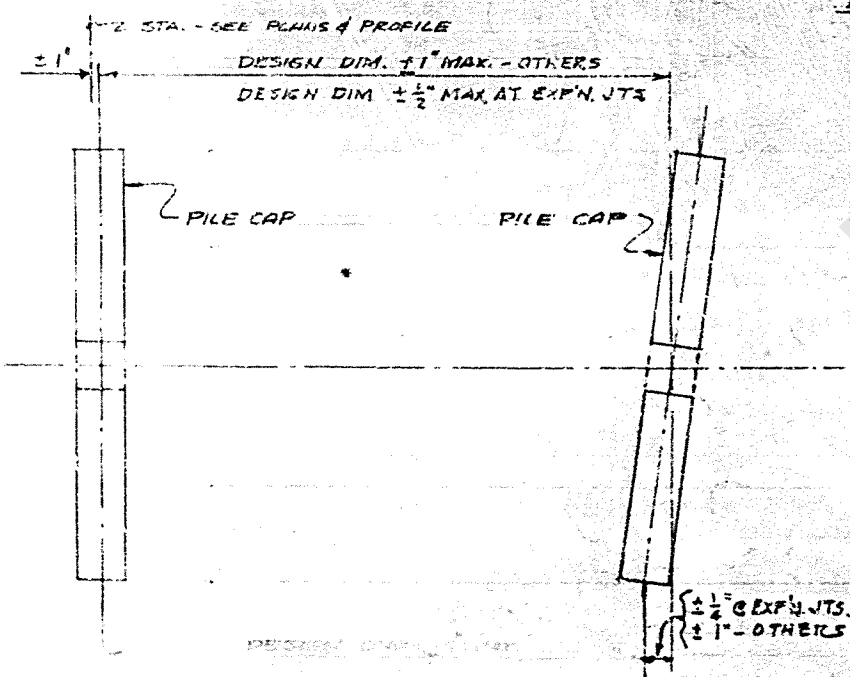

PIER PLAN
 SHOWING PLACING TOLERANCES
 SCALE: 1/4" = 1'-0"

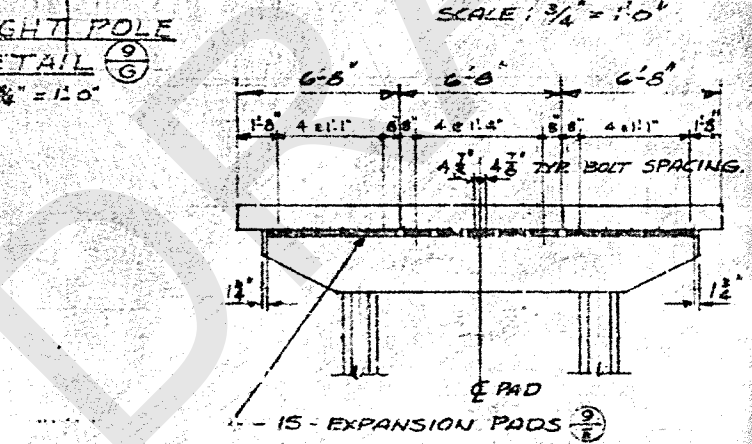

LIGHT POLE DETAIL
 SCALE: 3/4" = 1'-0"

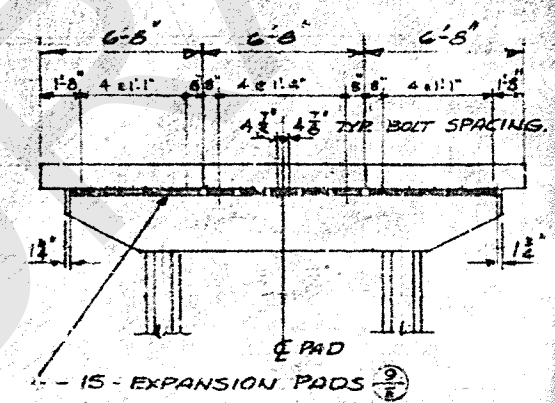

PAD SPACING AT EXP. JOINTS
 N.T.S.

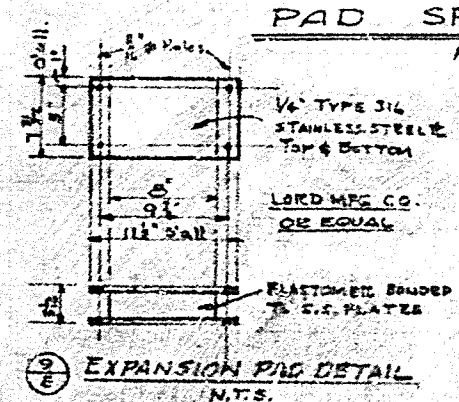

EXPANSION PAD DETAIL
 N.T.S.

LYKOS & GOLDHAMMER ARCHITECTS & ENGINEERS
 FERVER-DORLAND & ASSOCIATES
 STRUCTURAL ENGINEERS
 SAN DIEGO CALIFORNIA
 A JOINT VENTURE
 SIGNED: [Signatures]

OCEAN BEACH FISHING PIER			
CITY OF SAN DIEGO & STATE WILDLIFE CONSERVATION DEPARTMENT			
CITY OF SAN DIEGO ENGINEERING DEPARTMENT		SHEET 4 OF 51 SHEETS	
DESIGNED BY	DATE	APPROVED BY	DATE
AS BUILT	1-2-65	[Signature]	1-2-65
REVISION	BY	DATE	DESCRIPTION

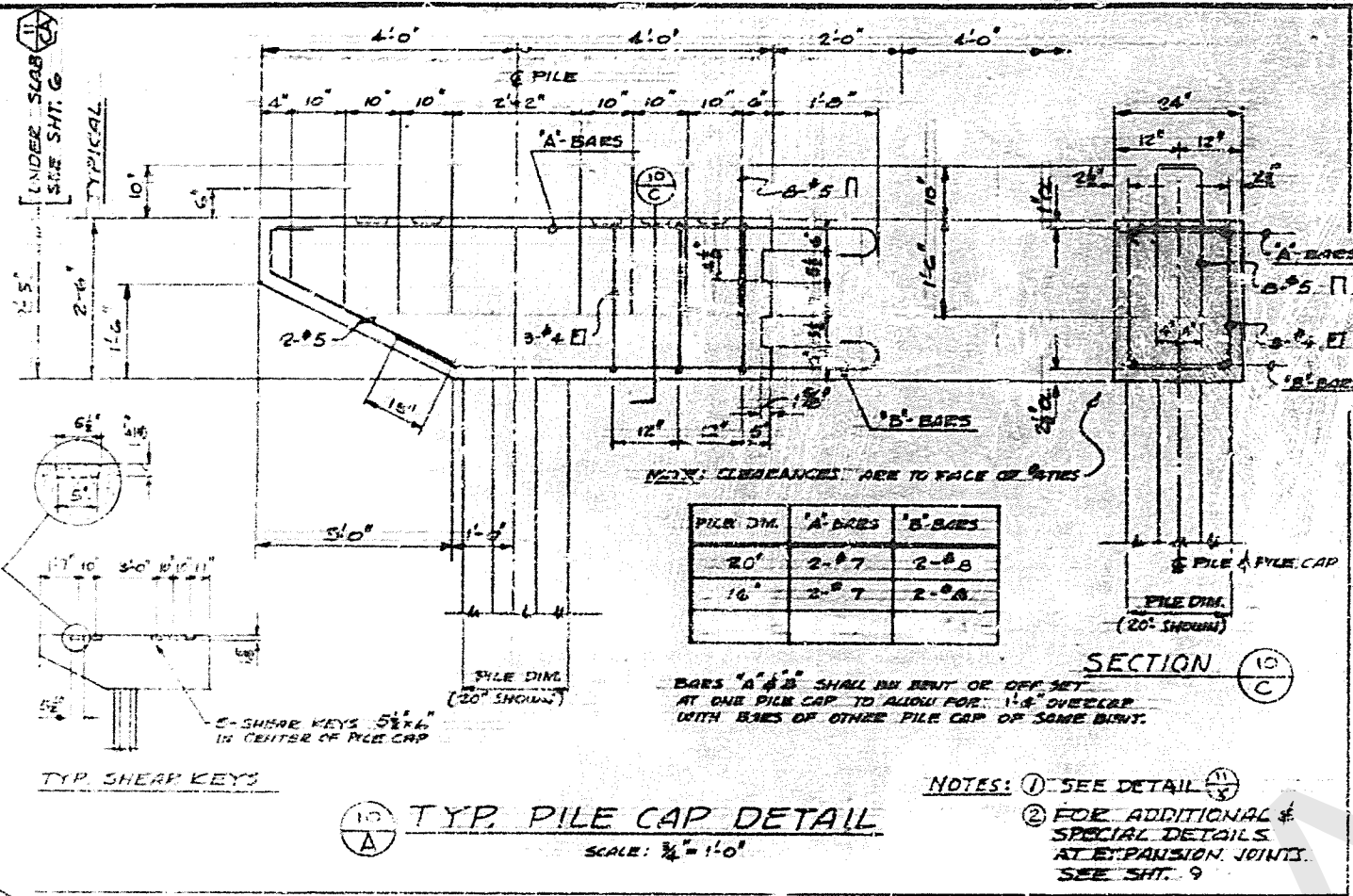

NOTES: ① SEE DETAIL (11) ② FOR ADDITIONAL & SPECIAL DETAILS AT EXPANSION JOINTS. SEE SHT. 9

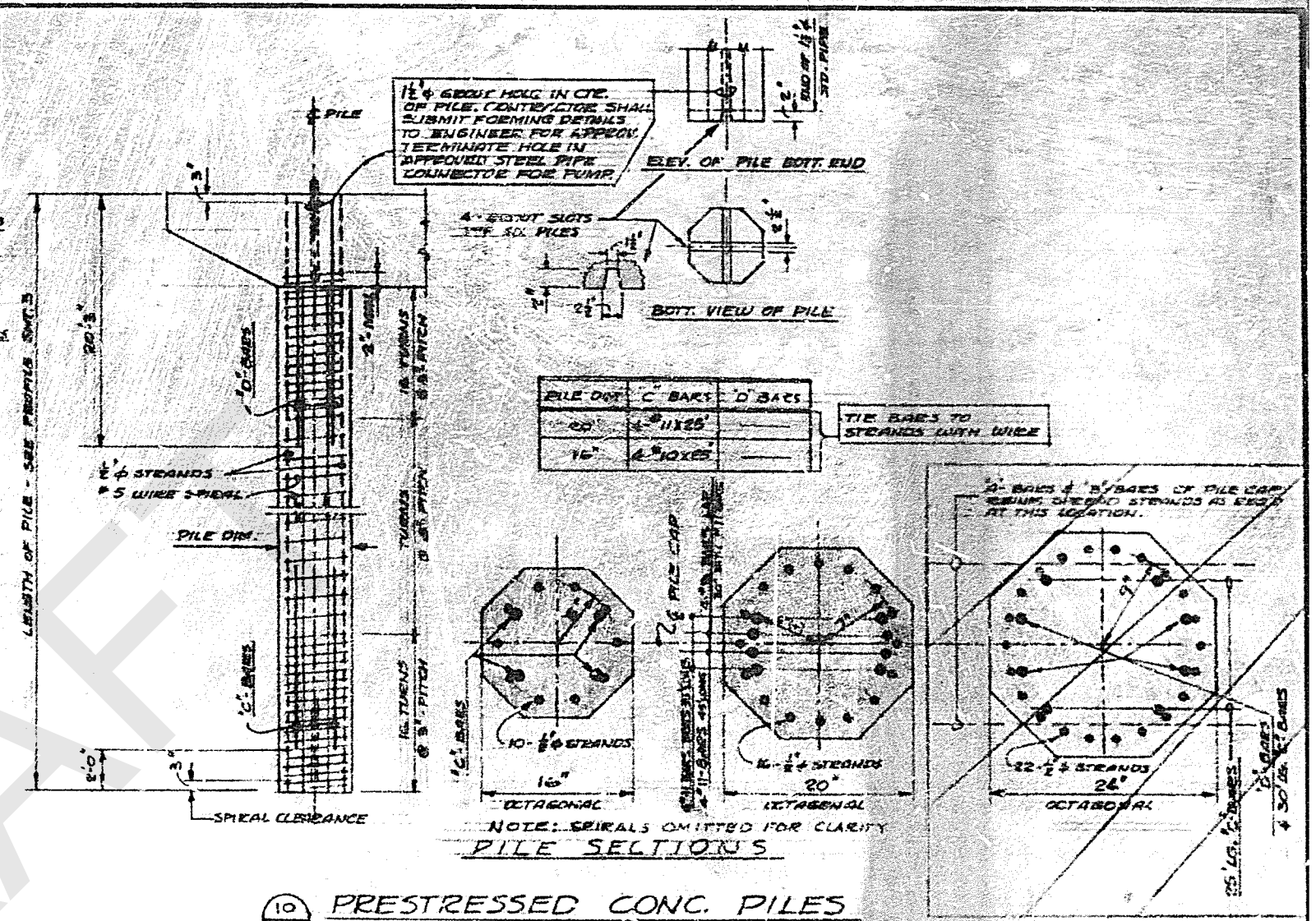

10/B PRESTRESSED CONC. PILES

NOTES: ① ALL STRANDS SHOWN ON PILE SECT. SHALL BE 1/4" 7 WIRE, UNCOATED, 270 KSI, STRESS-BELIEVED PRESTRESS STRANDS AND SHALL MEET THE FOLLOWING REQUIREMENTS: ASTM A416-59T AREA: 0.153 SQ. IN. MIN. ULTIMATE STRENGTH: 41,500 #/STRAND STRANDS SHALL BE TENSIONED TO A LOAD OF 23,000 #/STRAND ② CONCRETE TO HAVE A COMPRESSIVE STRENGTH OF $f'_c = 5000$ #/SQ. INCH AT 28 DAYS & 3500 #/SQ. INCH AT TIME OF PRESTRESS.

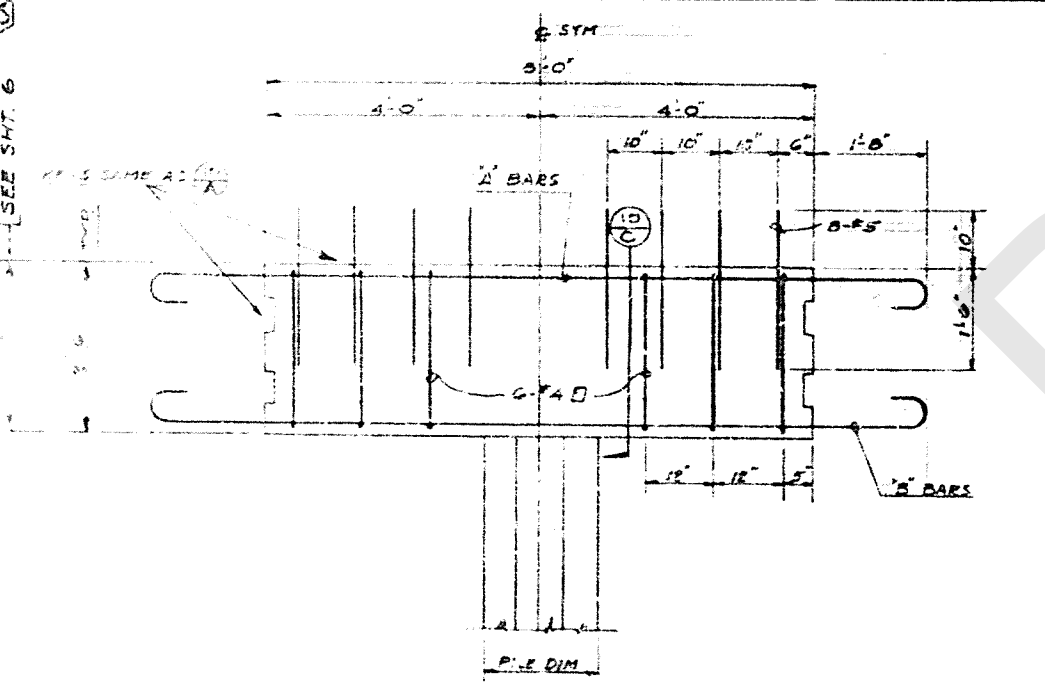

10/D SPECIAL PILE CAP DETAIL

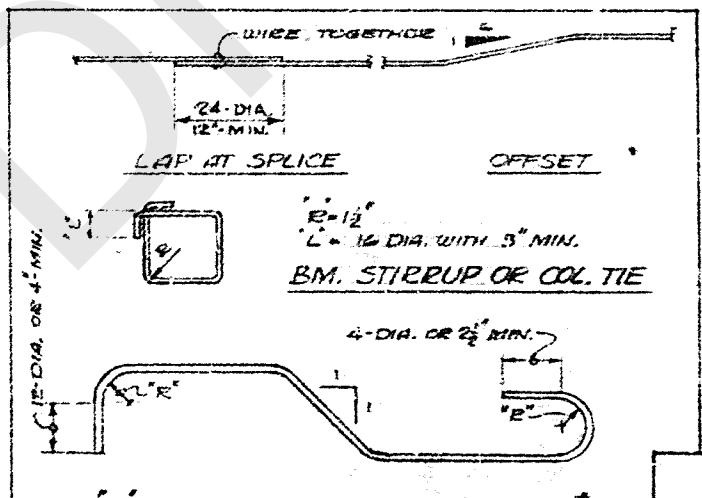

10/E TYP. BENDS IN REINF. BARS

LYKOS & GOLDHAMMER ARCHITECTS & ENGINEERS

FERVER-DORLAND & ASSOCIATES

STRUCTURAL ENGINEERS

SAN DIEGO CALIFORNIA

A JOINT VENTURE

SIGNED: [Signatures]

PRECAST PILE DETAILS			
OCEAN BEACH FISHING PIER			
FOR CITY OF SAN DIEGO & STATE WILDLIFE CONSERVATION BOARD			
CITY OF SAN DIEGO ENGINEERING DEPARTMENT		DATE 10/31/66	
PROJECT NO. 1746T		DATE 10/31/66	
NO.	BY	DATE	REVISION
1	WPC	10/31/66	ISSUED FOR PERMIT
2	WPC	11/1/66	REVISED PER COMMENTS
3	WPC	11/1/66	REVISED PER COMMENTS
4	WPC	11/1/66	REVISED PER COMMENTS
5	WPC	11/1/66	REVISED PER COMMENTS
6	WPC	11/1/66	REVISED PER COMMENTS
7	WPC	11/1/66	REVISED PER COMMENTS
8	WPC	11/1/66	REVISED PER COMMENTS
9	WPC	11/1/66	REVISED PER COMMENTS
10	WPC	11/1/66	REVISED PER COMMENTS

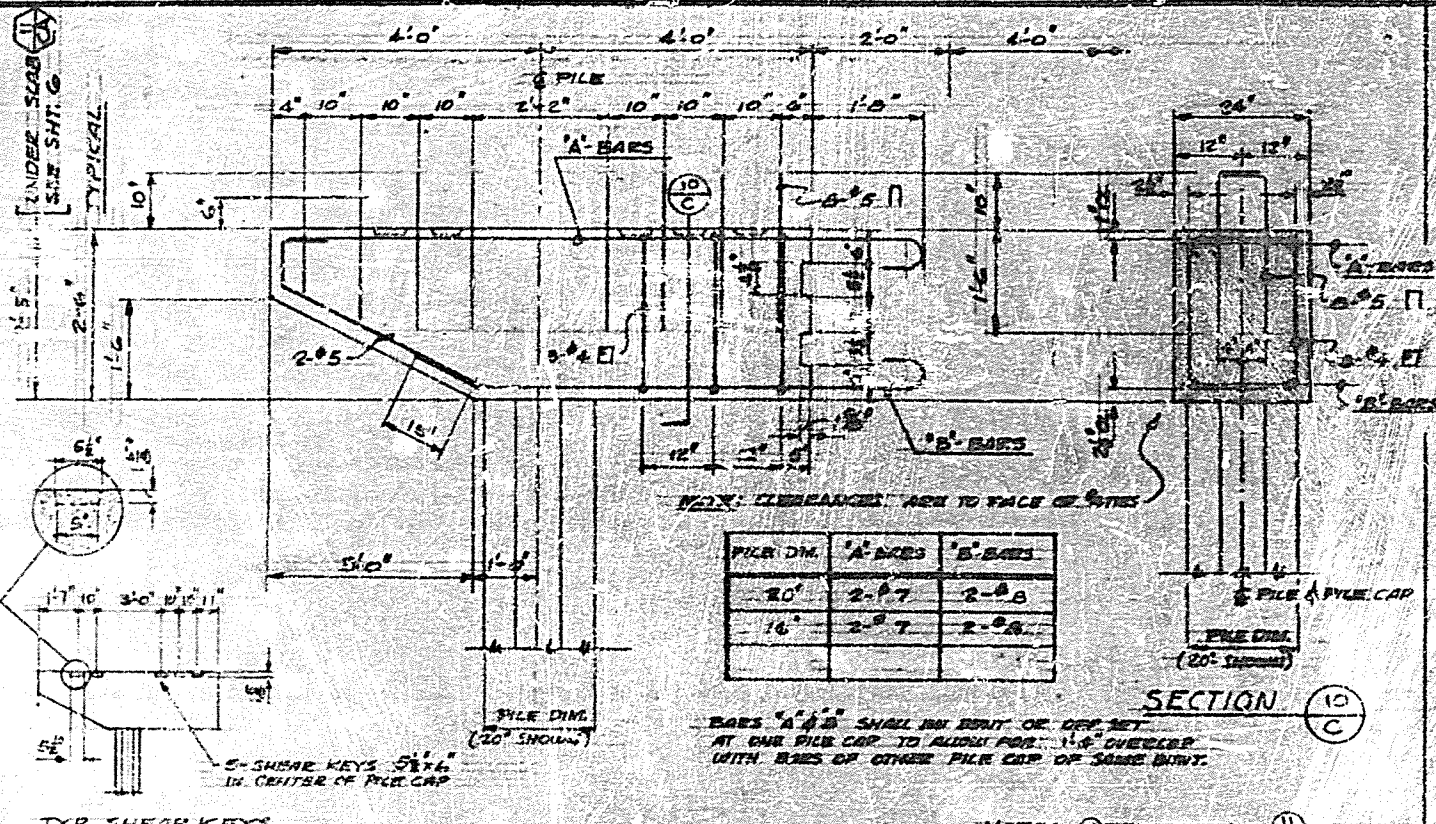

10 A TYP. PILE CAP DETAIL
SCALE: 1/4" = 1'-0"

NOTES: 1- SEE DETAIL 11
2- FOR ADDITIONAL & SPECIAL DETAILS AT EXPANSION JOINTS. SEE SHIT. 9

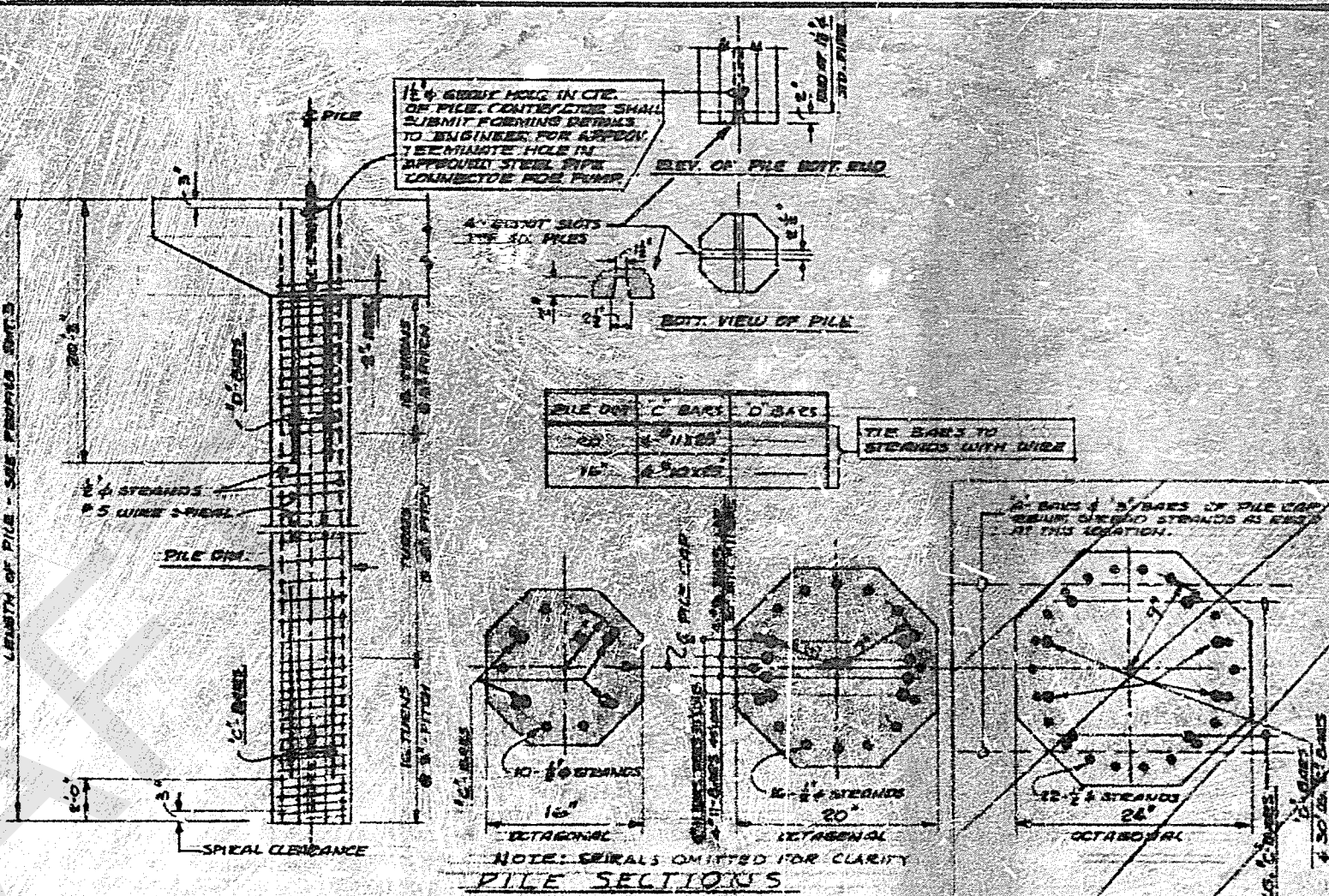

10 B PRESTRESSED CONC. PILES

NOTES: 1- ALL STRANDS SHOWN ON PILE SECT. SHALL BE #7 WIRE, UNCOATED, 270 KSI, STRESS-RELIEVED PRESTRESS STRANDS AND SHALL MEET THE FOLLOWING REQUIREMENTS: ASTM A416-57T
AREA: 0.153 SQ. IN.
MIN. ULTIMATE STRENGTH: 41,500 #/STRAND
STRANDS SHALL BE TENSIONED TO A LOAD OF 22,000 #/STRAND
2- CONCRETE TO HAVE A COMPRESSIVE STRENGTH OF $f'_c = 5000$ #/SQ. INCH AT 28 DAYS & 3500 #/SQ. INCH AT TIME OF PRESTRESS.

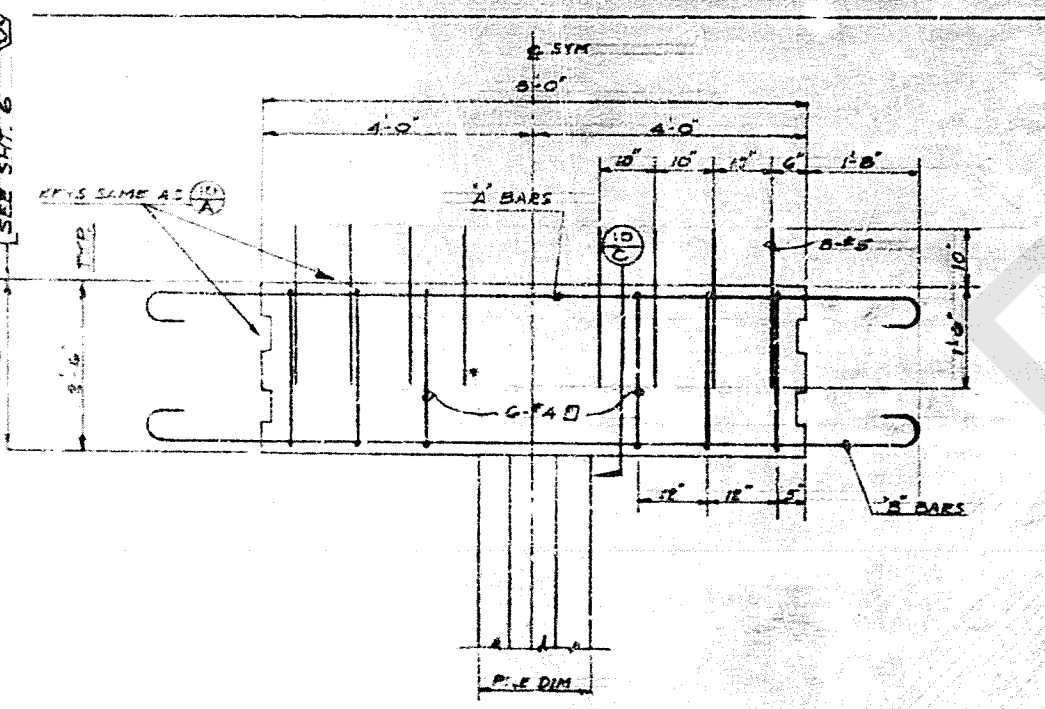

10 D SPECIAL PILE CAP DETAIL
SCALE: 1/4" = 1'-0"

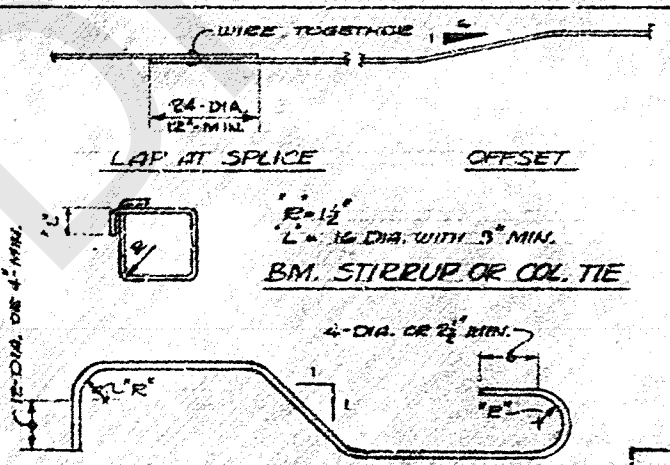

10 E TYP. BENDS IN REINF. BARS
NO SCALE

LYKOS & GOLDHAMMER ARCHITECTS & ENGINEERS
FERVER-DORLAND & ASSOCIATES
STRUCTURAL ENGINEERS
SAN DIEGO CALIFORNIA
A JOINT VENTURE
SIGNED: [Signatures]

PRECAST PILE DETAILS
OCEAN BEACH FISHING PIER
FOR
CITY OF SAN DIEGO & STATE WILDLIFE CONSERVATION BOARD
CITY OF SAN DIEGO ENGINEERING DEPARTMENT
DATE: 10/31/66
PROJECT NO. 7-2-66
DRAWING NO. 10-11-66

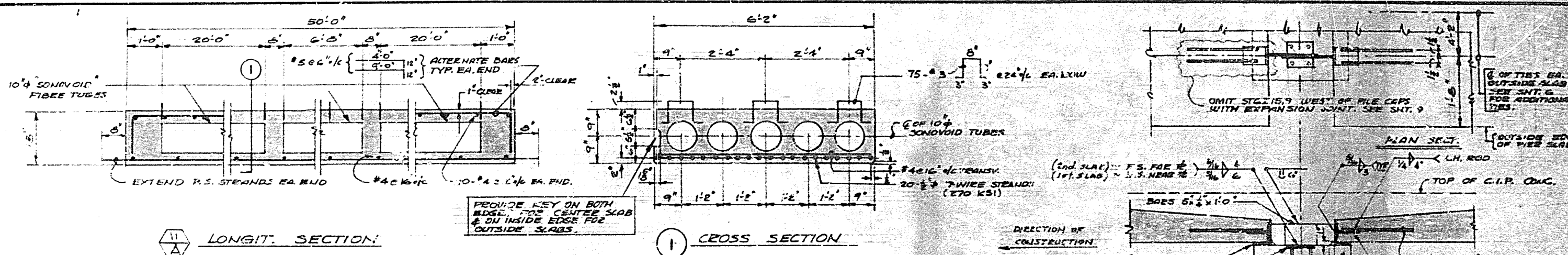

NOM'L. 50 FT. PRESTRESSED CONC. SLAB

NOTE: SLABS SHALL BE LIGHT-WT. CONC. - 115 LB./CU. FT. MAX.

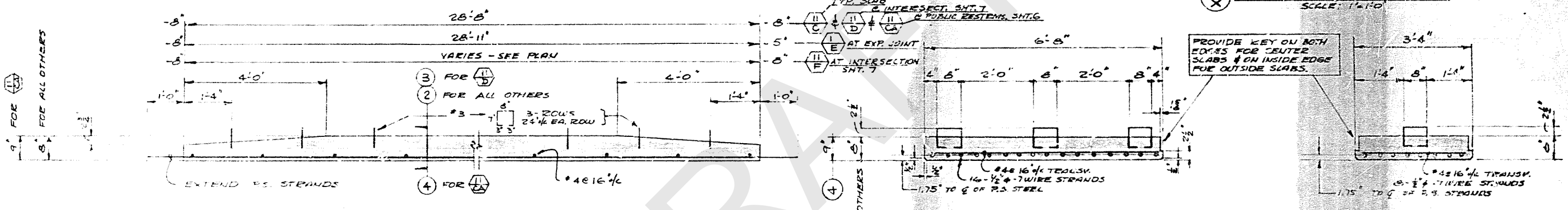

NOM'L. 30 FT. PRESTRESSED CONC. SLAB

1. CONC SHALL HAVE A COMP. STRENGTH OF $f_c = 5000 \text{ psi}$ AT 28 DAYS & 3500 psi AT TIME OF PRESTRESS. SLABS SHALL BE LIGHT WEIGHT (115 lb./cu. ft.) CONC. OTHER SLABS MAY BE EITHER LIGHT WEIGHT OR REGULAR WEIGHT CONCRETE.
2. ALL STRANDS SHOWN FOR SLABS SHALL BE $7/16 \text{ in.}$ 7-WIRE, UNCOATED, 270 KSI, STRESS-RELIEVED PRESTRESS STRANDS AND SHALL MEET THE FOLLOWING REQUIREMENTS: ASTM A416-59T. AREA: 0.153 sq. in. . MIN. ULTIMATE STRENGTH: 41,300 psi/strand . STRANDS SHALL BE 28 DAYS OR MORE OLD PRIOR TO INSTALLATION IN PIER.

LYKOS & GOLDHAMMER ARCHITECTS & ENGINEERS FERVER-DORLAND & ASSOCIATES STRUCTURAL ENGINEERS SAN DIEGO CALIFORNIA A JOINT VENTURE SIGNED <i>[Signature]</i>		PRECAST DECK SLAB DETAILS	
		OCEAN BEACH FISHING PIER FOR CITY OF SAN DIEGO & STATE WILDLIFE CONSERVATION BOARD	
CITY OF SAN DIEGO ENGINEERING DEPARTMENT SHEET 11 OF 31 SHEETS NO. 17467		DATE: 4/21/65 DRAWN BY: [Name] CHECKED BY: [Name]	
PLAN DIVISION DATE: 4-21-65 DRAWN BY: [Name]		APPROVALS: [Signatures and Dates]	
SAN DIEGO CALIFORNIA A JOINT VENTURE SIGNED <i>[Signature]</i>		MICROFILMED SEP 26 1966 AS BULLY 6150	

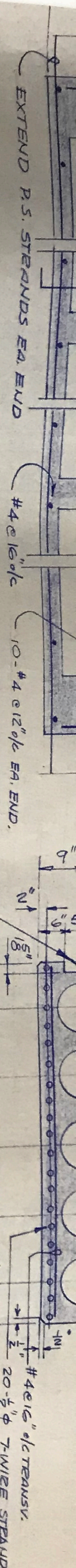

11
A
LONGIT. SECTION

1
CROSS SECTION

NOM'L. 50 FT. PRESTRESSED CONC. SLAB

NOTE: SLABS SHALL BE LIGHT-WT. CONC. - 115 LB./CU.FT. MAX.
SCALE: 3/4" = 1'-0"

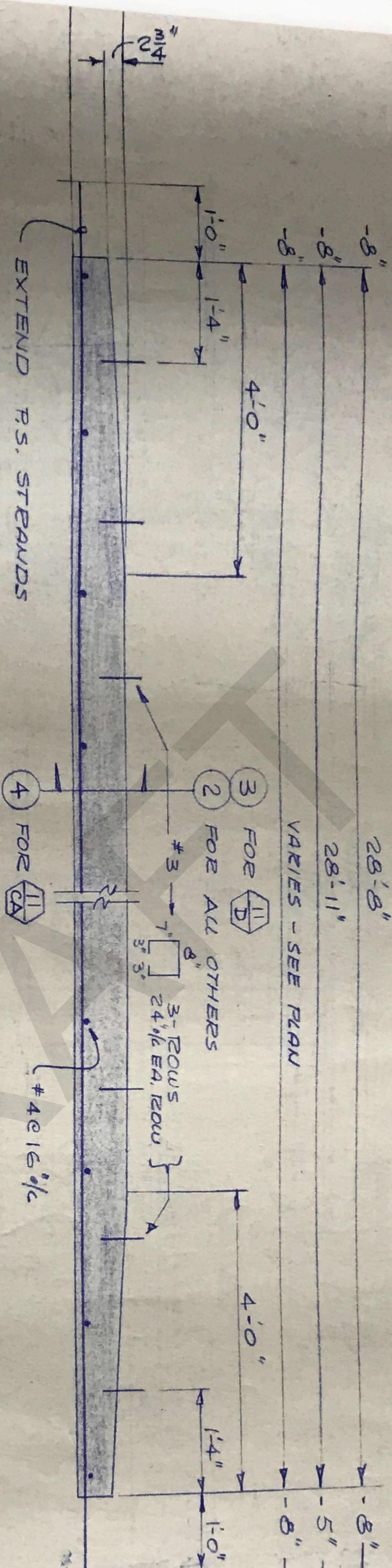

11
CA
11
C
11
D
11
E
11
F

LONGIT. SECTION

NOM'L. 30 FT. PRESTRESSED CONC. SLAB

SCALE: 3/4" = 1'-0"

1. CONC. SHALL HAVE A COMP. STRENGTH OF $f'_c = 5000 \text{ #/sq. in.}$ AT 28 DAYS & 3500 #/sq. in. AT TIME OF PRESTRESS. SLABS SHALL BE LIGHT WEIGHT (115 LB./CU.FT.) CONC. OTHER SLABS MAY BE EITHER LIGHT WEIGHT REGULAR WEIGHT CONCRETE.
2. ALL STRANDS SHOWN FOR SLABS SHALL BE $\frac{1}{2}$ " ϕ , 7-WIRE, UNCOATED, 270 KSI, STRESS-RELIEVED PRESTRESS STRANDS AND SHALL MEET THE FOLLOWING REQUIREMENTS: ASTM A416-59T AREA: 0.153 SQ. IN. MIN. ULTIMATE STRENGTH: 41,300 #/STRAND STRANDS SHALL BE TENSIONED TO A LOAD OF: 29,000 /STRAND
3. ALL SLABS SHALL BE 28 DAYS OR MORE OLD PRIOR TO INSTALLATION IN PIER.

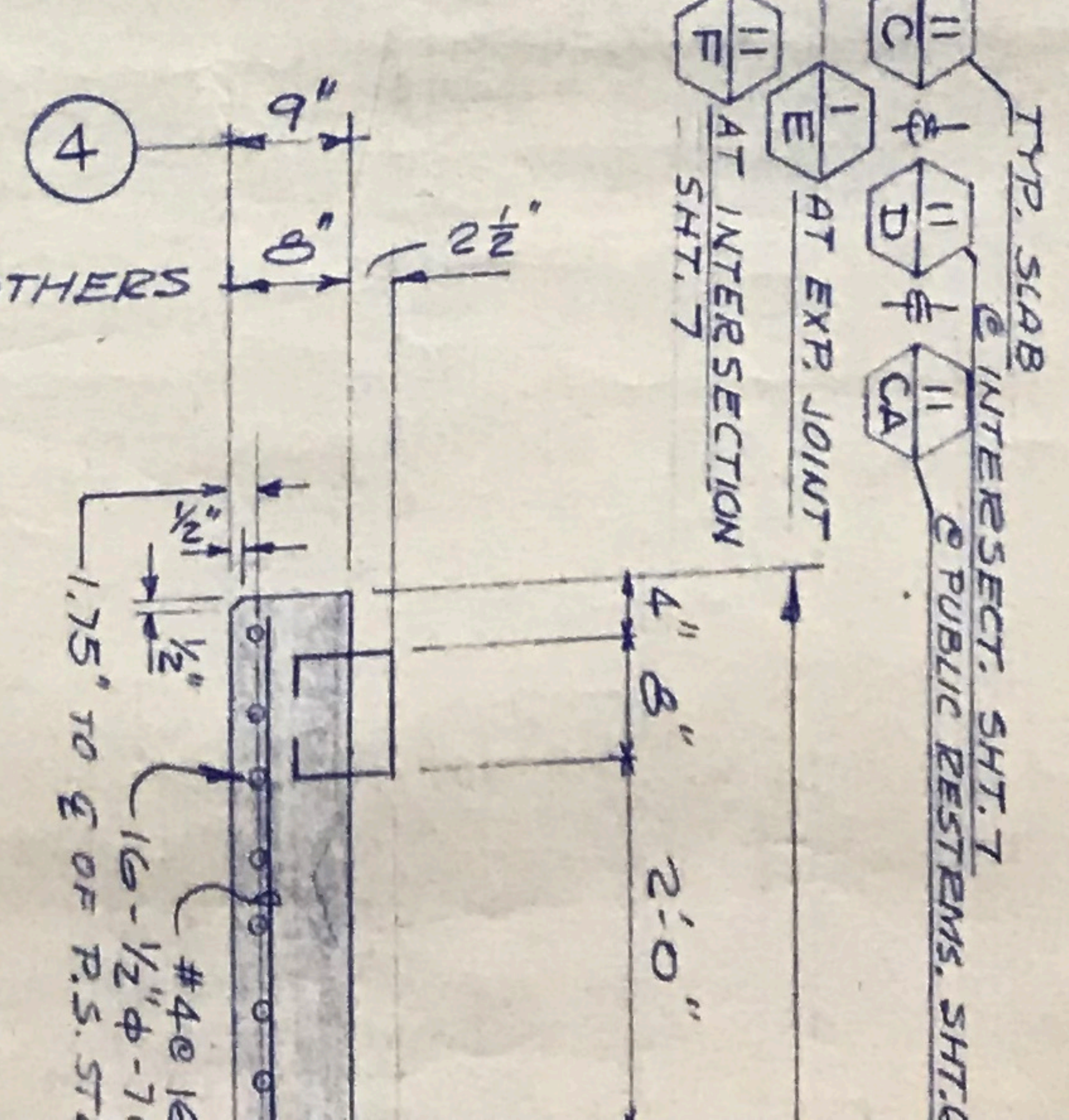

4

2
CR

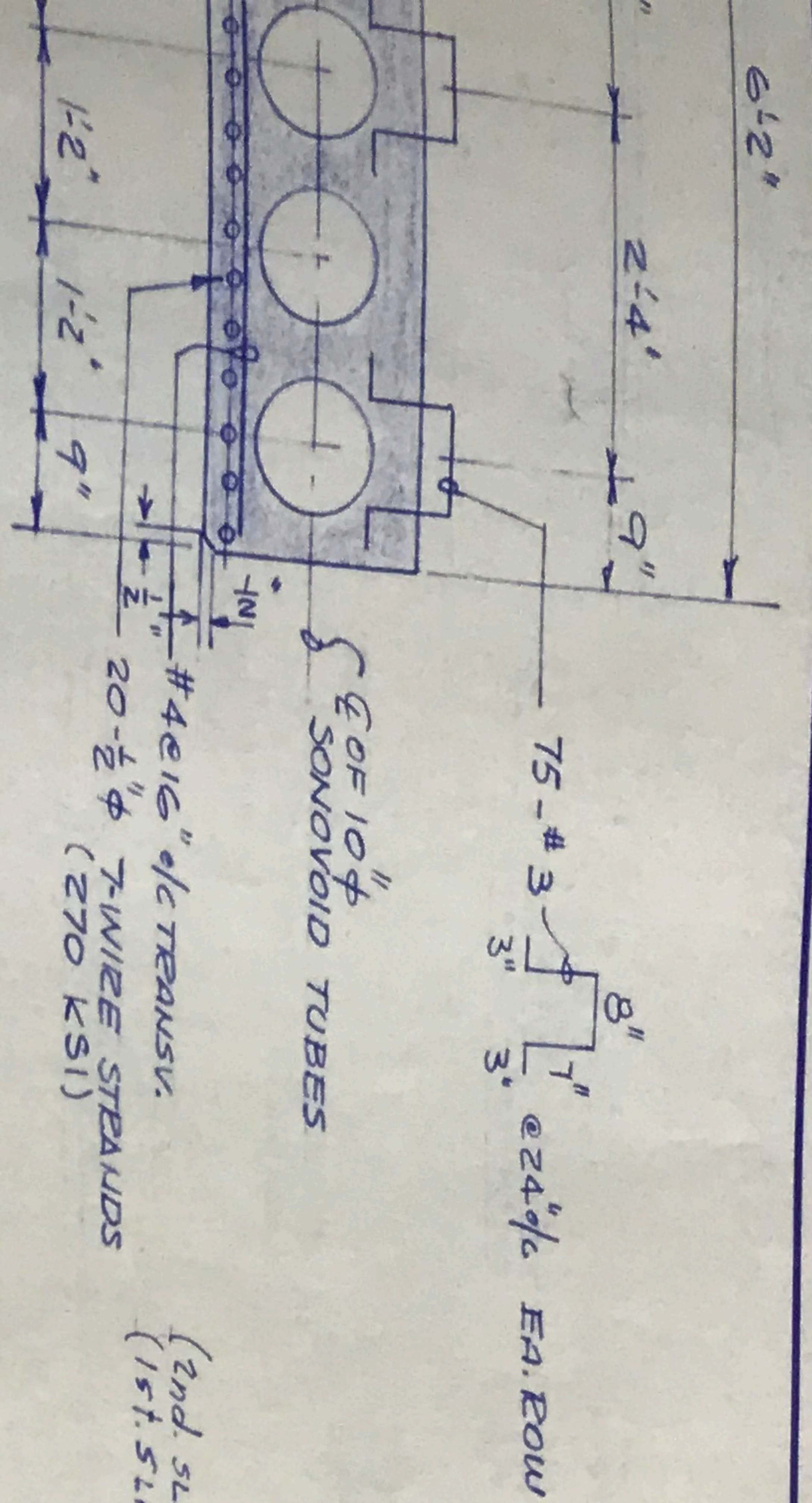

(2nd SLAB) ~ F.S. FACE #6
(1st SLAB) ~ N.S. NEAR #6

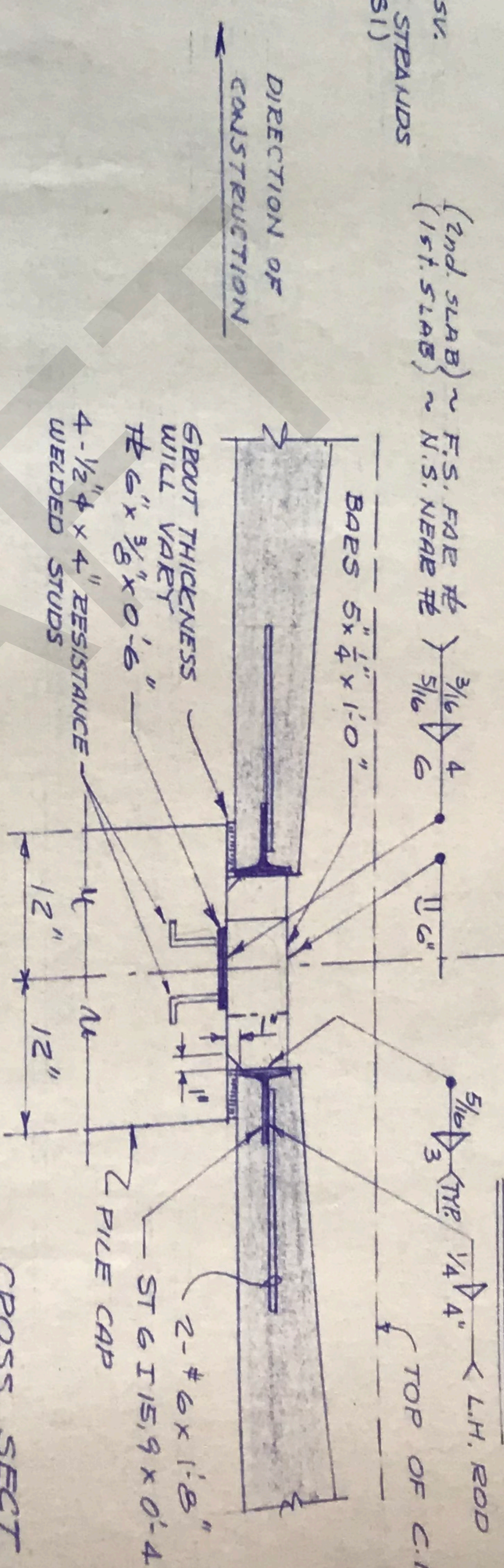
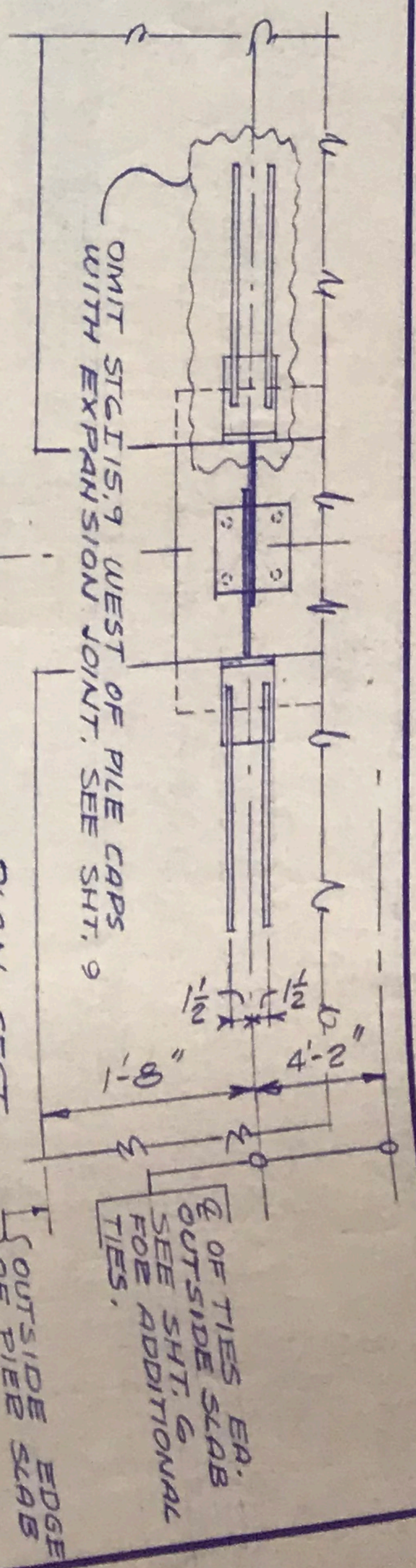

11 X SLAB TIE DETAIL (FOR 8" PRESTR.)
SCALE: 1"=1'-0"

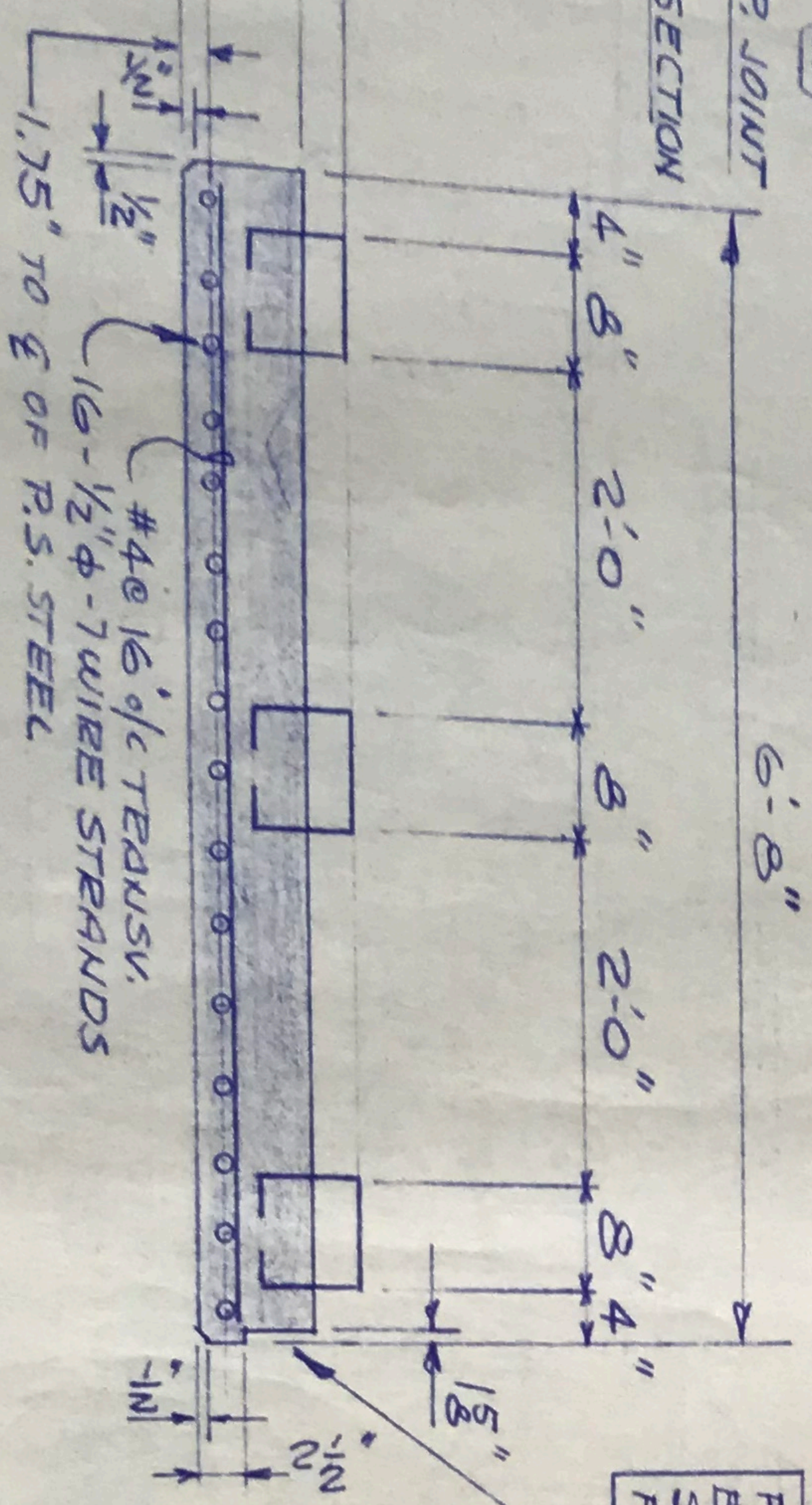
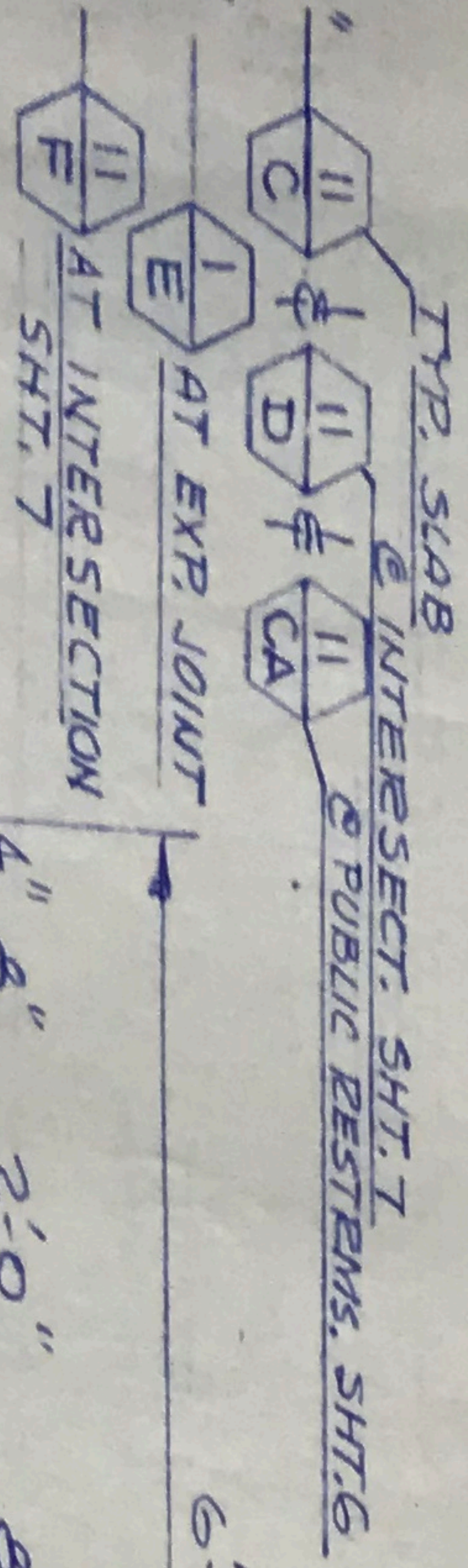

4 CROSS SECTION

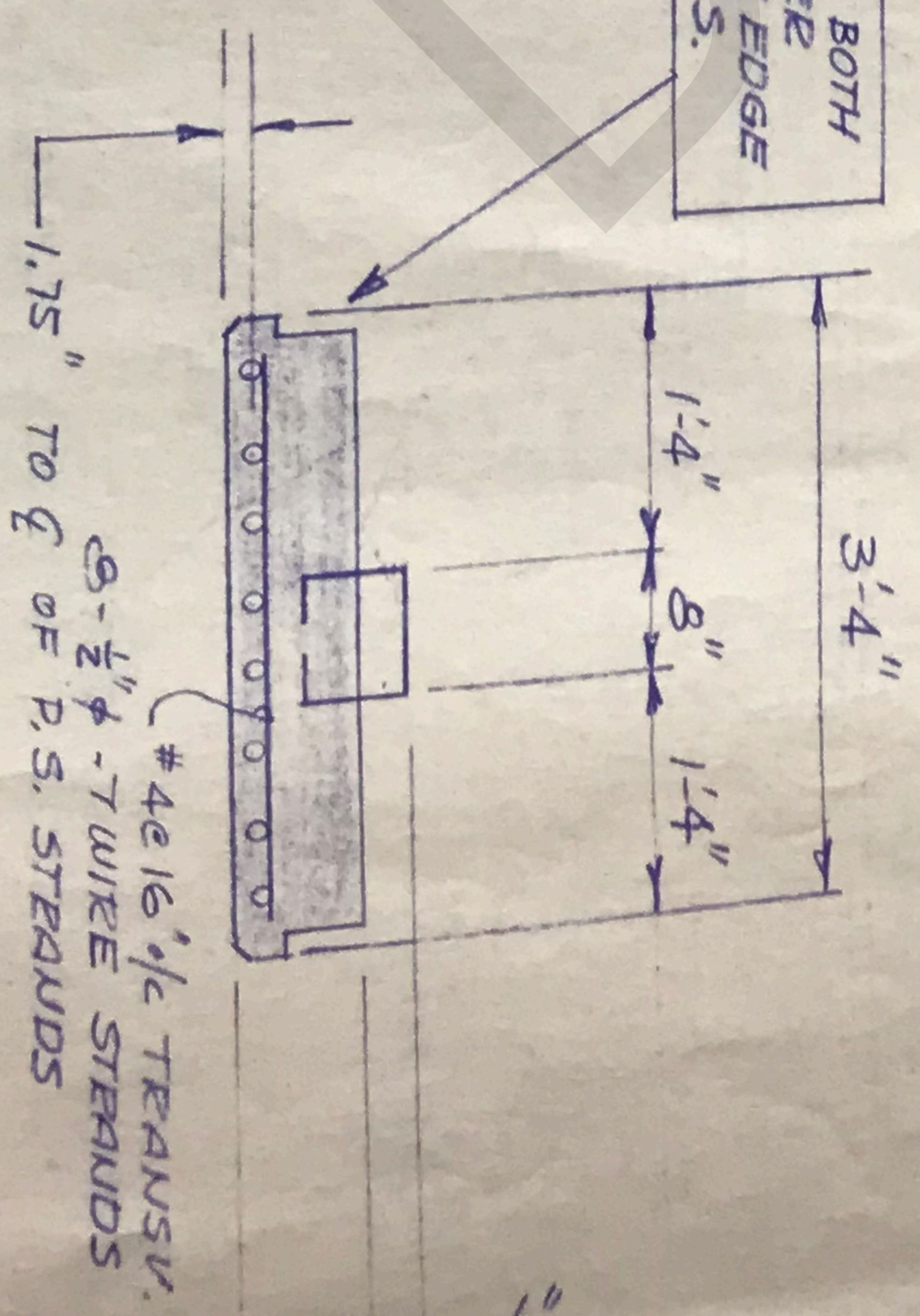

3 CROSS SECTION

4 2

3

Appendix B – Deck Detailed Calculations

DRAFT

Geometry and Material Input

NOTES:

- (1) b_w for hollow sections is the width of *ONE* web
- (2) Mild steel uses a bi-linear hardening model (hardening ratio: $b = E_{sh} / E_s$)
- (3) Prestressed / Post-Tensioned steel uses the Menegotto-Pinto model
- (4) Axial load is applied through the center of gravity of the section (c.g.c), ie no additional moment
- (5) Compressive force, stress, and strain are positive, tensile is negative (except in material definition)

Geometry

h =	12	in
h_{top} =		in
h_{bot} =		in
b_w =	80	in
b_{top} =		in
b_{bot} =		in
Shape:	SOLID	

Concrete Material Properties

f'_c =	5	ksi
β_1 =	0.8	
ϵ_{cu} =	0.003	in/in

Mild Steel Material Properties

E_s =	29,000	ksi
f_y =	60	ksi
b =		

PS / PT Material Properties

E_p =	28,500	ksi
f_{pu} =	270	ksi
σ_o =	253.6	ksi
R =	7.48	
b =	0.0105	

Axial Load on Section

P_a =		kip
---------	--	-----

Total Prestress: _____ **kip**

Long. Steel Required for Torsion

$A_{l,t}$ =		in^2
-------------	--	--------

Cross Section

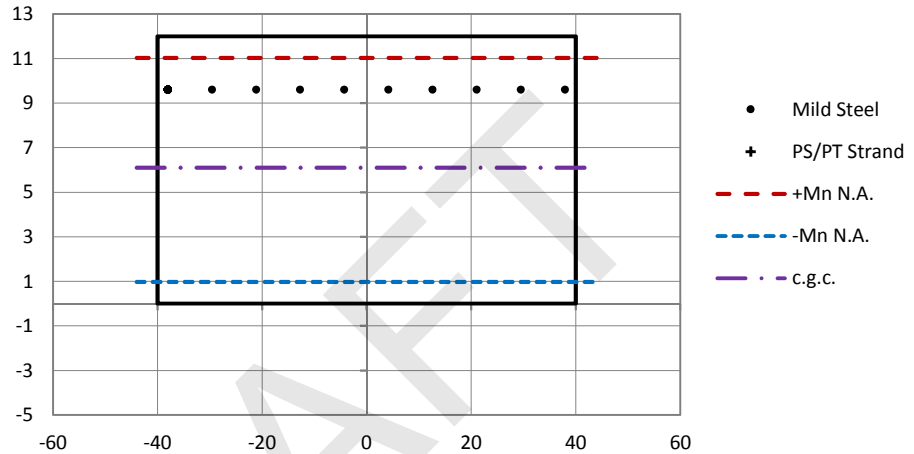

Steel Models

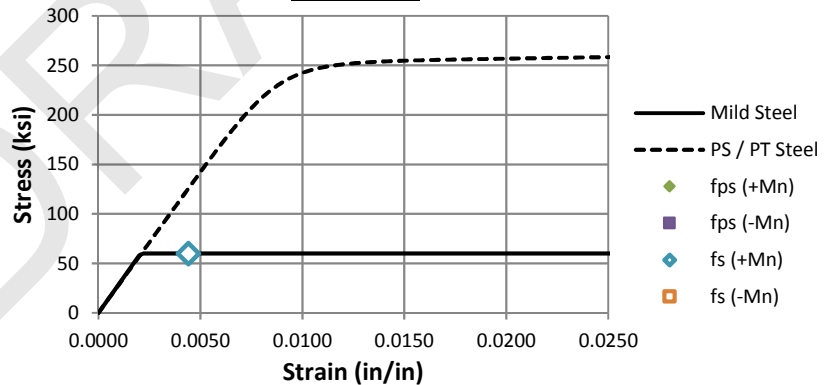

Mild Steel Locations

Layer	# bars	A_{bar} in^2	d_s in	Type
1	10	0.44	2.4	Main
2				
3				
4				
5				
6				
7				
8				
9				
10				
11				
12				

Prestressed / Post Tensioned Steel Locations

Layer	# strands	A_{strand} in^2	d_p in	f_{pe} ksi	Type
1					
2					
3					
4					
5					
6					
7					
8					
9					
10					
11					
12					



Client: City of San Diego
 Project: Ocean Beach Pier
 Design For: **Deck Evaluation**
Near Supports - NO DAMAGE

Job Number 9487
 Sheet 2 of 2
 Designer SJS Date _____
 Checker _____ Date _____

Negative Moment Capacity

NOTES:

- (1) Analysis of a reinforced concrete or prestressed beam per ACI 318-14 using strain compatibility
- (2) Positive stresses and strains are compressive, negative are tensile
- (3) Moments are calculated about the midheight of the cross section
- (4) The longitudinal steel area used for torsion is subtracted from each mild steel with *Type = Main* according to the ratio of $A_{l,torsion}$ to $A_{l,main}$. The area of steel with *Type = Skin* is not reduced for torsion, $A_{s,eff}$ is the effective area per layer including the reduction in steel area due to torsion.

NEGATIVE MOMENT CAPACITY

Concrete Response

c	a	A_c	ϵ_c	f_c	C_c	M_c
in	in	in ²	in/in	ksi	kip	kip-in
0.97	0.78	62.1	0.003	5.00	264	1,482

Prestressed / Post-Tensioned Steel Response

Layer	d_p	Type	$A_{p,total}$	f_{pe}	$\epsilon_{p,prestress}$	$\epsilon_{p,axial}$	$\epsilon_{p,flex}$	$\epsilon_{p,total}$	f_{ps}	F_p	M_p
	in		in ²	ksi	in/in	in/in	in/in	in/in	ksi	kip	kip-in
12											
11											
10											
9											
8											
7											
6											
5											
4											
3											
2											
1											

Steel Response

Layer	d_s	# bars	Type	$A_{s,total}$	$A_{s,eff}$	$\epsilon_{s,flex}$	$\epsilon_{s,axial}$	$\epsilon_{s,total}$	f_s	F_s	M_s
	in			in ²	in ²	in/in	in/in	in/in	ksi	kip	kip-in
12											
11											
10											
9											
8											
7											
6											
5											
4											
3											
2											
1	9.6	10	Main	4.40	4.40	-0.0267		-0.0267	-60.0	-264.0	950

Demand

$P_u =$ _____ **kip**
 $M_u =$ _____ **kip-ft**
 $\phi =$ 0.90 (ACI 21.2.2)

Reduced Moment Strength

$\Sigma M_{mid} =$ -203 **kip-ft**
 $\phi M_n =$ -182.4 **kip-ft**

$\Sigma F_s + \Sigma C_c = 0$ **OK!**

Flexural Strength Adequate!

Geometry and Material Input

NOTES:

- (1) b_w for hollow sections is the width of *ONE* web
- (2) Mild steel uses a bi-linear hardening model (hardening ratio: $b = E_{sh} / E_s$)
- (3) Prestressed / Post-Tensioned steel uses the Menegotto-Pinto model
- (4) Axial load is applied through the center of gravity of the section (c.g.c), ie no additional moment
- (5) Compressive force, stress, and strain are positive, tensile is negative (except in material definition)

Geometry

h =	10	in
h_{top} =		in
h_{bot} =		in
b_w =	80	in
b_{top} =		in
b_{bot} =		in
Shape:	SOLID	

Concrete Material Properties

f'_c =	5	ksi
β_1 =	0.8	
ϵ_{cu} =	0.003	in/in

Mild Steel Material Properties

E_s =	29,000	ksi
f_y =	60	ksi
b =		

PS / PT Material Properties

E_p =	28,500	ksi
f_{pu} =	270	ksi
σ_o =	253.6	ksi
R =	7.48	
b =	0.0105	

Axial Load on Section

P_a =		kip
---------	--	-----

Total Prestress: _____ kip

Long. Steel Required for Torsion

$A_{l,t}$ =		in ²
-------------	--	-----------------

Cross Section

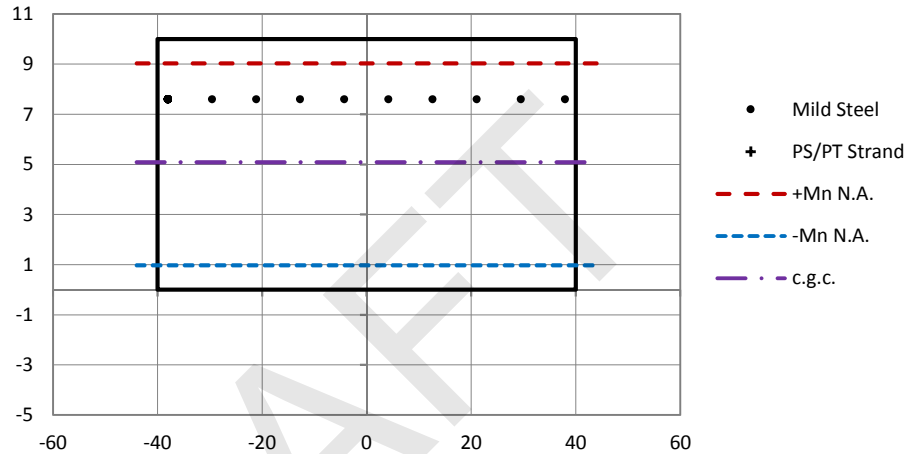

Steel Models

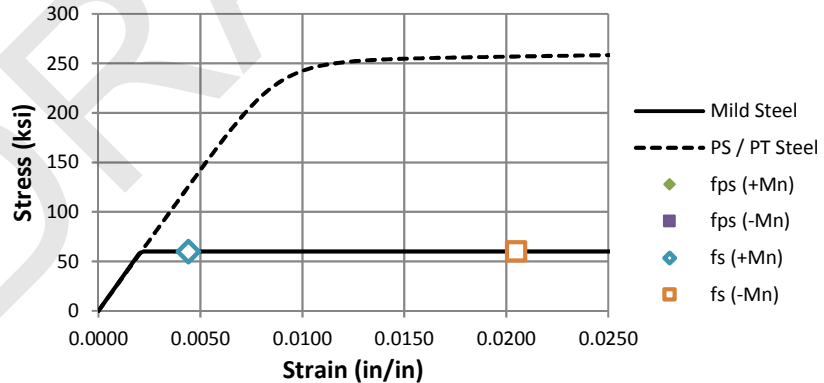

Mild Steel Locations

Layer	# bars	A_{bar} in ²	d_s in	Type
1	10	0.44	2.4	Main
2				
3				
4				
5				
6				
7				
8				
9				
10				
11				
12				

Prestressed / Post Tensioned Steel Locations

Layer	# strands	A_{strand} in ²	d_p in	f_{pe} ksi	Type
1					
2					
3					
4					
5					
6					
7					
8					
9					
10					
11					
12					



Client: City of San Diego
 Project: Ocean Beach Pier
 Design For: **Deck Evaluation**
Near Supports - Spalled Soffit

Job Number 9487
 Sheet 2 of 2
 Designer SJS Date _____
 Checker _____ Date _____

Negative Moment Capacity

NOTES:

- (1) Analysis of a reinforced concrete or prestressed beam per ACI 318-14 using strain compatibility
- (2) Positive stresses and strains are compressive, negative are tensile
- (3) Moments are calculated about the midheight of the cross section
- (4) The longitudinal steel area used for torsion is subtracted from each mild steel with *Type = Main* according to the ratio of $A_{l,torsion}$ to $A_{l,main}$. The area of steel with *Type = Skin* is not reduced for torsion, $A_{s,eff}$ is the effective area per layer including the reduction in steel area due to torsion.

NEGATIVE MOMENT CAPACITY

Concrete Response

c	a	A_c	ϵ_c	f_c	C_c	M_c
in	in	in ²	in/in	ksi	kip	kip-in
0.97	0.78	62.1	0.003	5.00	264	1,218

Prestressed / Post-Tensioned Steel Response

Layer	d_p in	Type	$A_{p,total}$ in ²	f_{pe} ksi	$\epsilon_{p,prestress}$ in/in	$\epsilon_{p,axial}$ in/in	$\epsilon_{p,flex}$ in/in	$\epsilon_{p,total}$ in/in	f_{ps} ksi	F_p kip	M_p kip-in
12											
11											
10											
9											
8											
7											
6											
5											
4											
3											
2											
1											

Steel Response

Layer	d_s in	# bars	Type	$A_{s,total}$ in ²	$A_{s,eff}$ in ²	$\epsilon_{s,flex}$ in/in	$\epsilon_{s,axial}$ in/in	$\epsilon_{s,total}$ in/in	f_s ksi	F_s kip	M_s kip-in
12											
11											
10											
9											
8											
7											
6											
5											
4											
3											
2											
1	7.6	10	Main	4.40	4.40	-0.0205		-0.0205	-60.0	-264.0	686

Demand

$P_u =$ _____ **kip**
 $M_u =$ _____ **kip-ft**
 $\phi =$ 0.90 (ACI 21.2.2)

Reduced Moment Strength

$\Sigma M_{mid} =$ -159 **kip-ft**
 $\phi M_n =$ -142.8 **kip-ft**

$\Sigma F_s + \Sigma C_c = 0$ **OK!**

Flexural Strength Adequate!



Original Undamaged

Methodology:

These calculations follow the provisions of ACI 318–14 for the shear design of reinforced concrete members ignoring any effects of axial load or prestress on the member.

Material Properties:

$f'_c = 4\text{ksi}$	Compressive strength of concrete
$f_y = 60\text{ksi}$	Yield strength of shear reinforcement
$\phi = 0.75$	Strength reduction factor for shear per Table 21.2.1
$\lambda = 0.75$	Lightweight concrete modification factor per Table 19.2.4.2

Section Properties:

$b_w = 80\text{in}$	Width of the web of the section
$d = 12\text{in} - 2.4\text{in} = 9.6 \cdot \text{in}$	Depth of the concrete section from the compressive face to the centroid of the tensile steel

Shear Strength:

$V_c = 2 \cdot \lambda \cdot \sqrt{f'_c \cdot \text{psi}} \cdot b_w \cdot d = 72.9 \cdot \text{kip}$	Nominal shear strength provided by the concrete per 22.5.5.1
------------------------------------------------------------------------------------------------------	--------------------------------------------------------------

$\phi V_n = \phi \cdot V_c = 55 \cdot \text{kip}$	Reduced shear strength of the section per 22.5.1.1
---------------------------------------------------	----------------------------------------------------

DRAFT



Methodology:

These calculations follow the provisions of ACI 318–14 for the shear design of reinforced concrete members ignoring any effects of axial load or prestress on the member.

Material Properties:

$f'_c = 4\text{ksi}$	Compressive strength of concrete
$f_y = 60\text{ksi}$	Yield strength of shear reinforcement
$\phi = 0.75$	Strength reduction factor for shear per Table 21.2.1
$\lambda = 0.75$	Lightweight concrete modification factor per Table 19.2.4.2

Section Properties:

$b_w = 80\text{in}$	Width of the web of the section
$d = 10\text{in} - 2.4\text{in} = 7.6 \cdot \text{in}$	Depth of the concrete section from the compressive face to the centroid of the tensile steel

Shear Strength:

$V_c = 2 \cdot \lambda \cdot \sqrt{f'_c \cdot \text{psi}} \cdot b_w \cdot d = 57.7 \cdot \text{kip}$	Nominal shear strength provided by the concrete per 22.5.5.1
------------------------------------------------------------------------------------------------------	--------------------------------------------------------------

$\phi V_n = \phi \cdot V_c = 43 \cdot \text{kip}$	Reduced shear strength of the section per 22.5.1.1
---------------------------------------------------	----------------------------------------------------

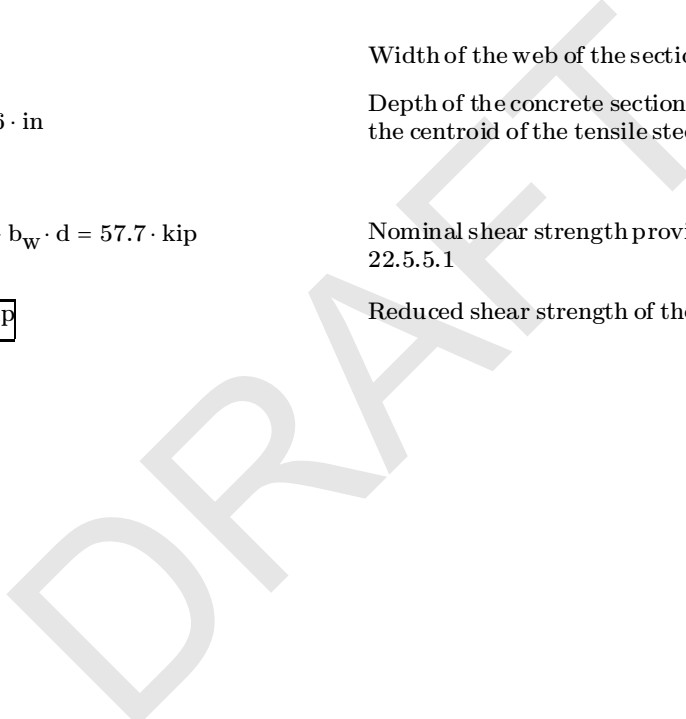

Geometry and Material Input

NOTES:

- (1) b_w for hollow sections is the width of *ONE* web
- (2) Mild steel uses a bi-linear hardening model (hardening ratio: $b = E_{sh} / E_s$)
- (3) Prestressed / Post-Tensioned steel uses the Menegotto-Pinto model
- (4) Axial load is applied through the center of gravity of the section (c.g.c), ie no additional moment
- (5) Compressive force, stress, and strain are positive, tensile is negative (except in material definition)

Geometry

h =	12	in
h_{top} =		in
h_{bot} =		in
b_w =	80	in
b_{top} =		in
b_{bot} =		in
Shape:	SOLID	

Concrete Material Properties

f'_c =	4	ksi
β_1 =	0.85	
ϵ_{cu} =	0.003	in/in

Mild Steel Material Properties

E_s =	29,000	ksi
f_y =	60	ksi
b =		

PS / PT Material Properties

E_p =	28,500	ksi
f_{pu} =	270	ksi
σ_o =	253.6	ksi
R =	7.48	
b =	0.0105	

Axial Load on Section

P_a =		kip
---------	--	-----

Total Prestress: **352.5 kip**

Long. Steel Required for Torsion

$A_{l,t}$ =		in^2
-------------	--	--------

Cross Section

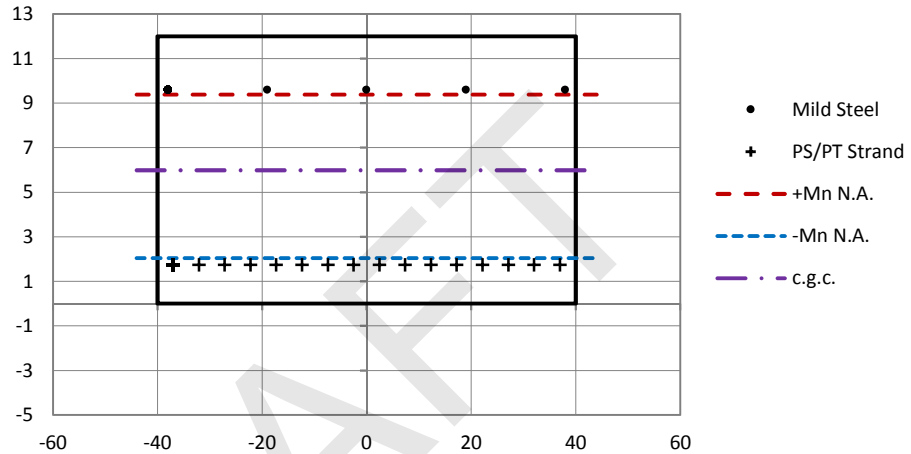

Steel Models

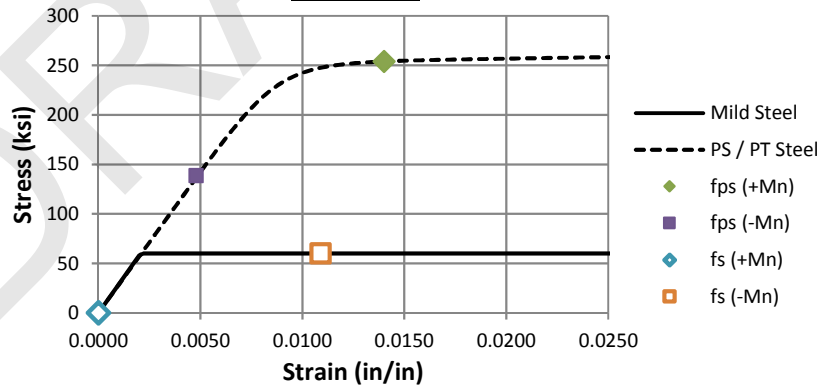

Mild Steel Locations

Layer	# bars	A_{bar} in^2	d_s in	Type
1	5	0.44	2.4	Main
2				
3				
4				
5				
6				
7				
8				
9				
10				
11				
12				

Prestressed / Post Tensioned Steel Locations

Layer	# strands	A_{strand} in^2	d_p in	f_{pe} ksi	Type
1	16	0.153	10.25	144	Bonded
2					
3					
4					
5					
6					
7					
8					
9					
10					
11					
12					



Client: City of San Diego
 Project: Ocean Beach Pier
 Design For: Deck Evaluation
Midspan - NO DAMAGE

Job Number 9487
 Sheet 2 of 2
 Designer SJS Date _____
 Checker _____ Date _____

Positive Moment Capacity

NOTES:

- (1) Analysis of a reinforced concrete or prestressed beam per ACI 318-14 using strain compatibility
- (2) Positive stresses and strains are compressive, negative are tensile
- (3) Moments are calculated about the midheight of the cross section
- (4) The longitudinal steel area used for torsion is subtracted from each mild steel with *Type = Main* according to the ratio of $A_{l,torsion}$ to $A_{l,main}$. The area of steel with *Type = Skin* is not reduced for torsion, $A_{s,eff}$ is the effective area per layer including the reduction in steel area due to torsion.

POSITIVE MOMENT CAPACITY

Concrete Response

c	a	A_c	ϵ_c	f_c	C_c	M_c
in	in	in ²	in/in	ksi	kip	kip-in
2.62	2.23	178.2	0.003	4.00	606	2,960

Prestressed / Post-Tensioned Steel Response

Layer	d_p	Type	$A_{p,total}$	f_{pe}	$\epsilon_{p,prestress}$	$\epsilon_{p,axial}$	$\epsilon_{p,flex}$	$\epsilon_{p,total}$	f_{ps}	F_p	M_p
	in		in ²	ksi	in/in	in/in	in/in	in/in	ksi	kip	kip-in
1	10.25	Bonded	2.45	144	-0.0051	-0.00025	-0.0087	-0.0140	-254.0	-621.9	2,643
2											
3											
4											
5											
6											
7											
8											
9											
10											
11											
12											

Steel Response

Layer	d_s	# bars	Type	$A_{s,total}$	$A_{s,eff}$	$\epsilon_{s,flex}$	$\epsilon_{s,axial}$	$\epsilon_{s,total}$	f_s	F_s	M_s
	in			in ²	in ²	in/in	in/in	in/in	ksi	kip	kip-in
1	2.4	5	Main	2.20	2.20	0.0003		0.0003	7.3	16.1	58
2											
3											
4											
5											
6											
7											
8											
9											
10											
11											
12											

Demand

$P_u =$ _____ kip
 $M_u =$ _____ kip-ft
 $\phi =$ 0.90 (ACI 21.2.2)

Reduced Moment Strength

$\Sigma M_{mid} =$ 472 kip-ft
 $\phi M_n =$ 424.6 kip-ft

$\Sigma F_s + \Sigma C_c = 0$ OK!

Flexural Strength Adequate!

Geometry and Material Input

NOTES:

- (1) b_w for hollow sections is the width of ONE web
- (2) Mild steel uses a bi-linear hardening model (hardening ratio: $b = E_{sh} / E_s$)
- (3) Prestressed / Post-Tensioned steel uses the Menegotto-Pinto model
- (4) Axial load is applied through the center of gravity of the section (c.g.c), ie no additional moment
- (5) Compressive force, stress, and strain are positive, tensile is negative (except in material definition)

Geometry

h =	12	in
h_{top} =		in
h_{bot} =		in
b_w =	80	in
b_{top} =		in
b_{bot} =		in
Shape:	SOLID	

Concrete Material Properties

f'_c =	4	ksi
β_1 =	0.85	
ϵ_{cu} =	0.003	in/in

Mild Steel Material Properties

E_s =	29,000	ksi
f_y =	60	ksi
b =		

PS / PT Material Properties

E_p =	28,500	ksi
f_{pu} =	270	ksi
σ_o =	253.6	ksi
R =	7.48	
b =	0.0105	

Axial Load on Section

P_a =		kip
---------	--	-----

Total Prestress: 330.5 kip

Long. Steel Required for Torsion

$A_{l,t}$ =		in^2
-------------	--	--------

Cross Section

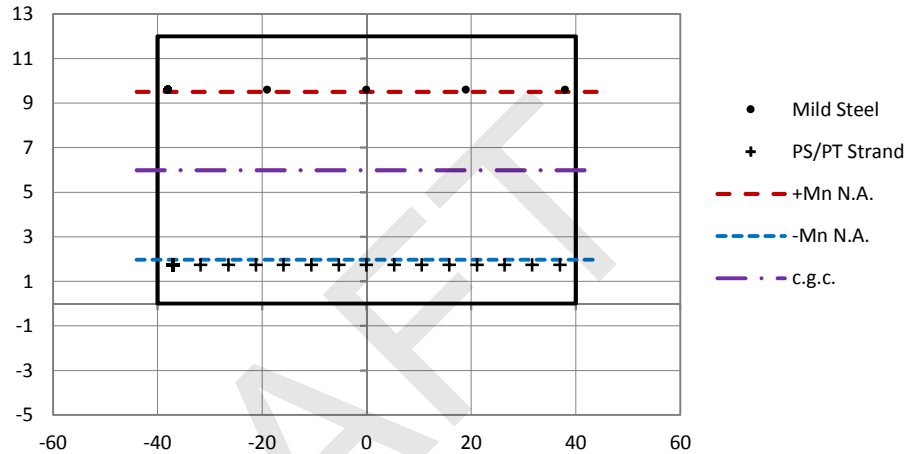

Steel Models

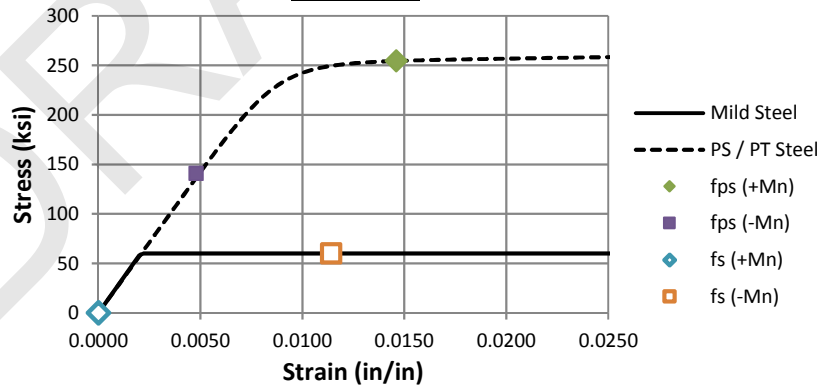

Mild Steel Locations

Layer	# bars	A_{bar} in^2	d_s in	Type
1	5	0.44	2.4	Main
2				
3				
4				
5				
6				
7				
8				
9				
10				
11				
12				

Prestressed / Post Tensioned Steel Locations

Layer	# strands	A_{strand} in^2	d_p in	f_{pe} ksi	Type
1	15	0.153	10.25	144	Bonded
2					
3					
4					
5					
6					
7					
8					
9					
10					
11					
12					



Client: City of San Diego
 Project: Ocean Beach Pier
 Design For: Deck Evaluation
Midspan - 1 Strand Missing

Job Number 9487
 Sheet 2 of 2
 Designer SJS Date _____
 Checker _____ Date _____

Positive Moment Capacity

NOTES:

- (1) Analysis of a reinforced concrete or prestressed beam per ACI 318-14 using strain compatibility
- (2) Positive stresses and strains are compressive, negative are tensile
- (3) Moments are calculated about the midheight of the cross section
- (4) The longitudinal steel area used for torsion is subtracted from each mild steel with *Type = Main* according to the ratio of $A_{l,torsion}$ to $A_{l,main}$. The area of steel with *Type = Skin* is not reduced for torsion, $A_{s,eff}$ is the effective area per layer including the reduction in steel area due to torsion.

POSITIVE MOMENT CAPACITY

Concrete Response

c	a	A_c	ϵ_c	f_c	C_c	M_c
in	in	in ²	in/in	ksi	kip	kip-in
2.49	2.12	169.6	0.003	4.00	577	2,849

Prestressed / Post-Tensioned Steel Response

Layer	d_p	Type	$A_{p,total}$	f_{pe}	$\epsilon_{p,prestress}$	$\epsilon_{p,axial}$	$\epsilon_{p,flex}$	$\epsilon_{p,total}$	f_{ps}	F_p	M_p
	in		in ²	ksi	in/in	in/in	in/in	in/in	ksi	kip	kip-in
1	10.25	Bonded	2.30	144	-0.0051	-0.00023	-0.0093	-0.0146	-254.5	-584.1	2,482
2											
3											
4											
5											
6											
7											
8											
9											
10											
11											
12											

Steel Response

Layer	d_s	# bars	Type	$A_{s,total}$	$A_{s,eff}$	$\epsilon_{s,flex}$	$\epsilon_{s,axial}$	$\epsilon_{s,total}$	f_s	F_s	M_s
	in			in ²	in ²	in/in	in/in	in/in	ksi	kip	kip-in
1	2.4	5	Main	2.20	2.20	0.0001		0.0001	3.3	7.3	26
2											
3											
4											
5											
6											
7											
8											
9											
10											
11											
12											

Demand

$P_u =$ _____ kip
 $M_u =$ _____ kip-ft
 $\phi =$ 0.90 (ACI 21.2.2)

Reduced Moment Strength

$\Sigma M_{mid} =$ 446 kip-ft
 $\phi M_n =$ 401.8 kip-ft

$\Sigma F_s + \Sigma C_c = 0$ OK!

Flexural Strength Adequate!

Geometry and Material Input

NOTES:

- (1) b_w for hollow sections is the width of ONE web
- (2) Mild steel uses a bi-linear hardening model (hardening ratio: $b = E_{sh} / E_s$)
- (3) Prestressed / Post-Tensioned steel uses the Menegotto-Pinto model
- (4) Axial load is applied through the center of gravity of the section (c.g.c), ie no additional moment
- (5) Compressive force, stress, and strain are positive, tensile is negative (except in material definition)

Geometry

h =	12	in
h_{top} =		in
h_{bot} =		in
b_w =	80	in
b_{top} =		in
b_{bot} =		in
Shape:	SOLID	

Concrete Material Properties

f'_c =	4	ksi
β_1 =	0.85	
ϵ_{cu} =	0.003	in/in

Mild Steel Material Properties

E_s =	29,000	ksi
f_y =	60	ksi
b =		

PS / PT Material Properties

E_p =	28,500	ksi
f_{pu} =	270	ksi
σ_o =	253.6	ksi
R =	7.48	
b =	0.0105	

Axial Load on Section

P_a =		kip
---------	--	-----

Total Prestress: 308.4 kip

Long. Steel Required for Torsion

$A_{l,t}$ =		in^2
-------------	--	--------

Cross Section

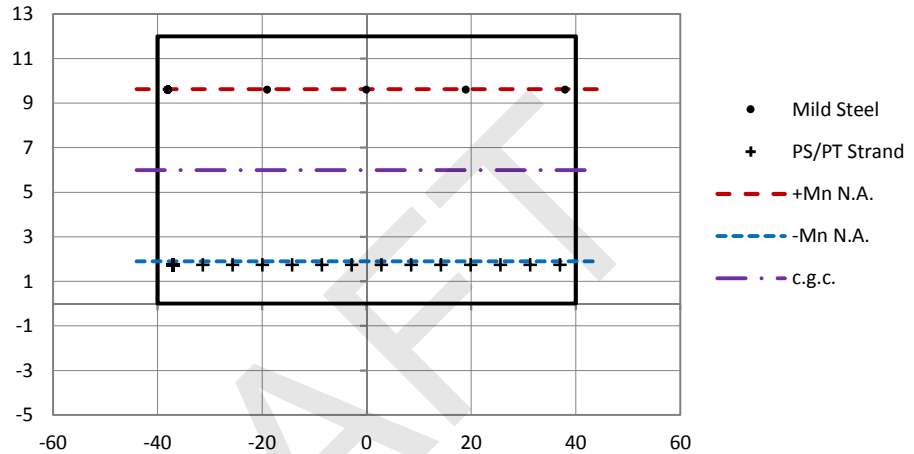

Steel Models

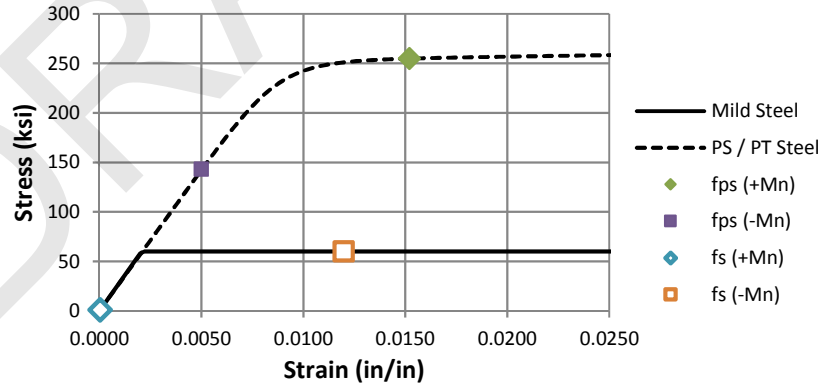

Mild Steel Locations

Layer	# bars	A_{bar} in^2	d_s in	Type
1	5	0.44	2.4	Main
2				
3				
4				
5				
6				
7				
8				
9				
10				
11				
12				

Prestressed / Post Tensioned Steel Locations

Layer	# strands	A_{strand} in^2	d_p in	f_{pe} ksi	Type
1	14	0.153	10.25	144	Bonded
2					
3					
4					
5					
6					
7					
8					
9					
10					
11					
12					



Client: City of San Diego
 Project: Ocean Beach Pier
 Design For: Deck Evaluation
Midspan - 2 Strands Missing

Job Number 9487
 Sheet 2 of 2
 Designer SJS Date _____
 Checker _____ Date _____

Positive Moment Capacity

NOTES:

- (1) Analysis of a reinforced concrete or prestressed beam per ACI 318-14 using strain compatibility
- (2) Positive stresses and strains are compressive, negative are tensile
- (3) Moments are calculated about the midheight of the cross section
- (4) The longitudinal steel area used for torsion is subtracted from each mild steel with *Type = Main* according to the ratio of $A_{l,torsion}$ to $A_{l,main}$. The area of steel with *Type = Skin* is not reduced for torsion, $A_{s,eff}$ is the effective area per layer including the reduction in steel area due to torsion.

POSITIVE MOMENT CAPACITY

Concrete Response

c	a	A_c	ϵ_c	f_c	C_c	M_c
in	in	in ²	in/in	ksi	kip	kip-in
2.37	2.02	161.3	0.003	4.00	548	2,737

Prestressed / Post-Tensioned Steel Response

Layer	d_p	Type	$A_{p,total}$	f_{pe}	$\epsilon_{p,prestress}$	$\epsilon_{p,axial}$	$\epsilon_{p,flex}$	$\epsilon_{p,total}$	f_{ps}	F_p	M_p
	in		in ²	ksi	in/in	in/in	in/in	in/in	ksi	kip	kip-in
1	10.25	Bonded	2.14	144	-0.0051	-0.00022	-0.0100	-0.0152	-254.9	-546.0	2,320
2											
3											
4											
5											
6											
7											
8											
9											
10											
11											
12											

Steel Response

Layer	d_s	# bars	Type	$A_{s,total}$	$A_{s,eff}$	$\epsilon_{s,flex}$	$\epsilon_{s,axial}$	$\epsilon_{s,total}$	f_s	F_s	M_s
	in			in ²	in ²	in/in	in/in	in/in	ksi	kip	kip-in
1	2.4	5	Main	2.20	2.20	0.0000		0.0000	-1.0	-2.3	-8
2											
3											
4											
5											
6											
7											
8											
9											
10											
11											
12											

Demand

$P_u =$ _____ kip
 $M_u =$ _____ kip-ft
 $\phi =$ 0.90 (ACI 21.2.2)

Reduced Moment Strength

$\Sigma M_{mid} =$ 421 kip-ft
 $\phi M_n =$ 378.7 kip-ft

$\Sigma F_s + \Sigma C_c = 0$ OK!

Flexural Strength Adequate!

Geometry and Material Input

NOTES:

- (1) b_w for hollow sections is the width of *ONE* web
- (2) Mild steel uses a bi-linear hardening model (hardening ratio: $b = E_{sh} / E_s$)
- (3) Prestressed / Post-Tensioned steel uses the Menegotto-Pinto model
- (4) Axial load is applied through the center of gravity of the section (c.g.c), ie no additional moment
- (5) Compressive force, stress, and strain are positive, tensile is negative (except in material definition)

Geometry

h =	12	in
h_{top} =		in
h_{bot} =		in
b_w =	80	in
b_{top} =		in
b_{bot} =		in
Shape:	SOLID	

Concrete Material Properties

f'_c =	4	ksi
β_1 =	0.85	
ϵ_{cu} =	0.003	in/in

Mild Steel Material Properties

E_s =	29,000	ksi
f_y =	60	ksi
b =		

PS / PT Material Properties

E_p =	28,500	ksi
f_{pu} =	270	ksi
σ_o =	253.6	ksi
R =	7.48	
b =	0.0105	

Axial Load on Section

P_a =		kip
---------	--	-----

Total Prestress: 286.4 kip

Long. Steel Required for Torsion

$A_{l,t}$ =		in ²
-------------	--	-----------------

Cross Section

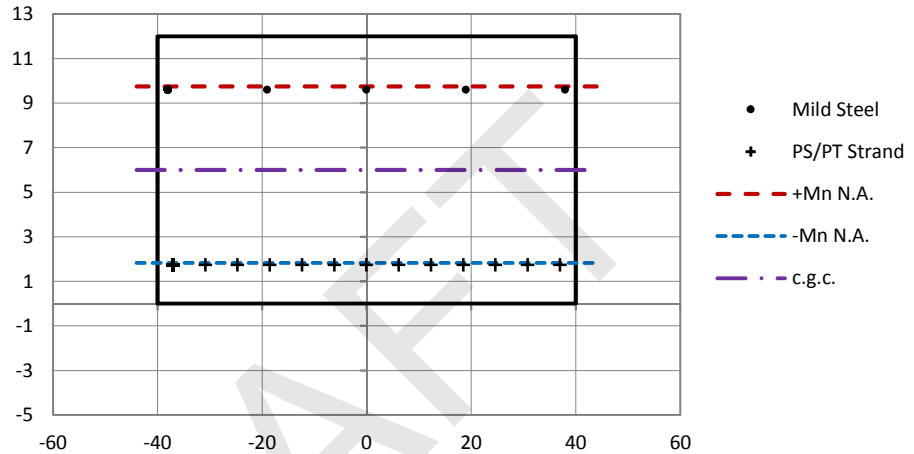

Steel Models

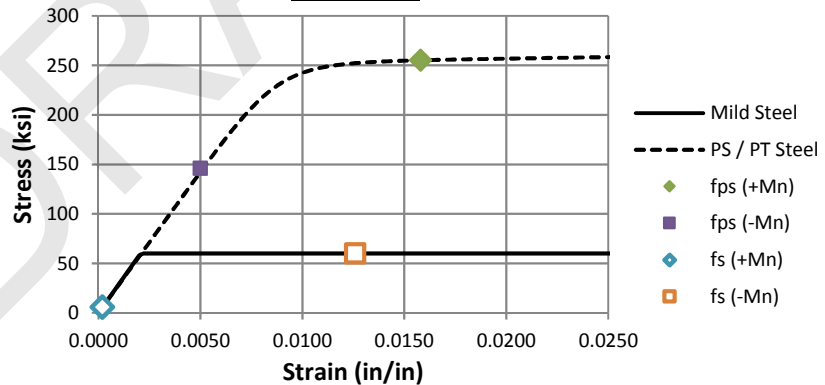

Mild Steel Locations

Layer	# bars	A_{bar} in ²	d_s in	Type
1	5	0.44	2.4	Main
2				
3				
4				
5				
6				
7				
8				
9				
10				
11				
12				

Prestressed / Post Tensioned Steel Locations

Layer	# strands	A_{strand} in ²	d_p in	f_{pe} ksi	Type
1	13	0.153	10.25	144	Bonded
2					
3					
4					
5					
6					
7					
8					
9					
10					
11					
12					



Client: City of San Diego
 Project: Ocean Beach Pier
 Design For: Deck Evaluation
Midspan - 4 Strands Missing

Job Number 9487
 Sheet 2 of 2
 Designer SJS Date _____
 Checker _____ Date _____

Positive Moment Capacity

NOTES:

- (1) Analysis of a reinforced concrete or prestressed beam per ACI 318-14 using strain compatibility
- (2) Positive stresses and strains are compressive, negative are tensile
- (3) Moments are calculated about the midheight of the cross section
- (4) The longitudinal steel area used for torsion is subtracted from each mild steel with *Type = Main* according to the ratio of $A_{l,torsion}$ to $A_{l,main}$. The area of steel with *Type = Skin* is not reduced for torsion, $A_{s,eff}$ is the effective area per layer including the reduction in steel area due to torsion.

POSITIVE MOMENT CAPACITY

Concrete Response

c	a	A_c	ϵ_c	f_c	C_c	M_c
in	in	in ²	in/in	ksi	kip	kip-in
2.25	1.91	153.1	0.003	4.00	520	2,625

Prestressed / Post-Tensioned Steel Response

Layer	d_p	Type	$A_{p,total}$	f_{pe}	$\epsilon_{p,prestress}$	$\epsilon_{p,axial}$	$\epsilon_{p,flex}$	$\epsilon_{p,total}$	f_{ps}	F_p	M_p
	in		in ²	ksi	in/in	in/in	in/in	in/in	ksi	kip	kip-in
1	10.25	Bonded	1.99	144	-0.0051	-0.00020	-0.0107	-0.0159	-255.3	-507.7	2,158
2											
3											
4											
5											
6											
7											
8											
9											
10											
11											
12											

Steel Response

Layer	d_s	# bars	Type	$A_{s,total}$	$A_{s,eff}$	$\epsilon_{s,flex}$	$\epsilon_{s,axial}$	$\epsilon_{s,total}$	f_s	F_s	M_s
	in			in ²	in ²	in/in	in/in	in/in	ksi	kip	kip-in
1	2.4	5	Main	2.20	2.20	-0.0002		-0.0002	-5.8	-12.7	-46
2											
3											
4											
5											
6											
7											
8											
9											
10											
11											
12											

Demand

$P_u =$ _____ kip
 $M_u =$ _____ kip-ft
 $\phi =$ 0.90 (ACI 21.2.2)

Reduced Moment Strength

$\Sigma M_{mid} =$ 395 kip-ft
 $\phi M_n =$ 355.3 kip-ft

$\Sigma F_s + \Sigma C_c = 0$ OK!

Flexural Strength Adequate!

Geometry and Material Input

NOTES:

- (1) b_w for hollow sections is the width of ONE web
- (2) Mild steel uses a bi-linear hardening model (hardening ratio: $b = E_{sh} / E_s$)
- (3) Prestressed / Post-Tensioned steel uses the Menegotto-Pinto model
- (4) Axial load is applied through the center of gravity of the section (c.g.c), ie no additional moment
- (5) Compressive force, stress, and strain are positive, tensile is negative (except in material definition)

Geometry

h =	12	in
h_{top} =		in
h_{bot} =		in
b_w =	80	in
b_{top} =		in
b_{bot} =		in
Shape:	SOLID	

Concrete Material Properties

f'_c =	4	ksi
β_1 =	0.85	
ϵ_{cu} =	0.003	in/in

Mild Steel Material Properties

E_s =	29,000	ksi
f_y =	60	ksi
b =		

PS / PT Material Properties

E_p =	28,500	ksi
f_{pu} =	270	ksi
σ_o =	253.6	ksi
R =	7.48	
b =	0.0105	

Axial Load on Section

P_a =		kip
---------	--	-----

Total Prestress: **264.4 kip**

Long. Steel Required for Torsion

$A_{l,t}$ =		in^2
-------------	--	--------

Cross Section

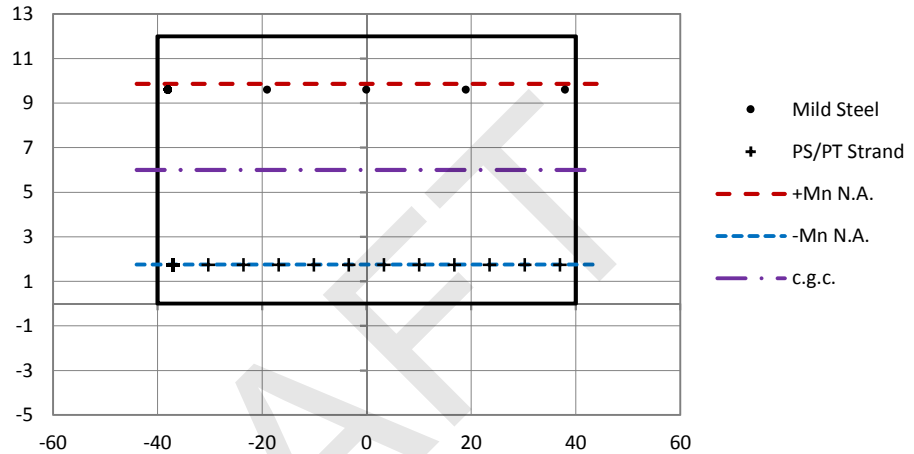

Steel Models

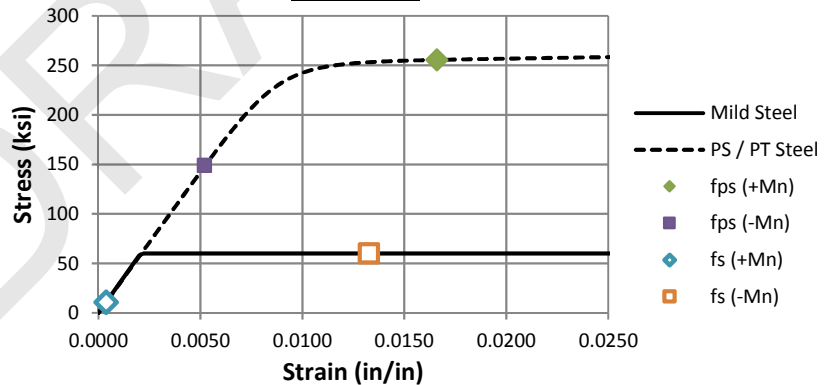

Mild Steel Locations

Layer	# bars	A_{bar} in^2	d_s in	Type
1	5	0.44	2.4	Main
2				
3				
4				
5				
6				
7				
8				
9				
10				
11				
12				

Prestressed / Post Tensioned Steel Locations

Layer	# strands	A_{strand} in^2	d_p in	f_{pe} ksi	Type
1	12	0.153	10.25	144	Bonded
2					
3					
4					
5					
6					
7					
8					
9					
10					
11					
12					



Client: City of San Diego
 Project: Ocean Beach Pier
 Design For: Deck Evaluation
Midspan - 4 Strands Missing

Job Number 9487
 Sheet 2 of 2
 Designer SJS Date _____
 Checker _____ Date _____

Positive Moment Capacity

NOTES:

- (1) Analysis of a reinforced concrete or prestressed beam per ACI 318-14 using strain compatibility
- (2) Positive stresses and strains are compressive, negative are tensile
- (3) Moments are calculated about the midheight of the cross section
- (4) The longitudinal steel area used for torsion is subtracted from each mild steel with *Type = Main* according to the ratio of $A_{l,torsion}$ to $A_{l,main}$. The area of steel with *Type = Skin* is not reduced for torsion, $A_{s,eff}$ is the effective area per layer including the reduction in steel area due to torsion.

POSITIVE MOMENT CAPACITY

Concrete Response

c	a	A_c	ϵ_c	f_c	C_c	M_c
in	in	in ²	in/in	ksi	kip	kip-in
2.13	1.81	145.1	0.003	4.00	493	2,512

Prestressed / Post-Tensioned Steel Response

Layer	d_p	Type	$A_{p,total}$	f_{pe}	$\epsilon_{p,prestress}$	$\epsilon_{p,axial}$	$\epsilon_{p,flex}$	$\epsilon_{p,total}$	f_{ps}	F_p	M_p
	in		in ²	ksi	in/in	in/in	in/in	in/in	ksi	kip	kip-in
1	10.25	Bonded	1.84	144	-0.0051	-0.00019	-0.0114	-0.0167	-255.6	-469.3	1,995
2											
3											
4											
5											
6											
7											
8											
9											
10											
11											
12											

Steel Response

Layer	d_s	# bars	Type	$A_{s,total}$	$A_{s,eff}$	$\epsilon_{s,flex}$	$\epsilon_{s,axial}$	$\epsilon_{s,total}$	f_s	F_s	M_s
	in			in ²	in ²	in/in	in/in	in/in	ksi	kip	kip-in
1	2.4	5	Main	2.20	2.20	-0.0004		-0.0004	-10.9	-23.9	-86
2											
3											
4											
5											
6											
7											
8											
9											
10											
11											
12											

Demand

$P_u =$ _____ kip
 $M_u =$ _____ kip-ft
 $\phi =$ 0.90 (ACI 21.2.2)

Reduced Moment Strength

$\Sigma M_{mid} =$ 368 kip-ft
 $\phi M_n =$ 331.5 kip-ft

$\Sigma F_s + \Sigma C_c = 0$ OK!

Flexural Strength Adequate!

Geometry and Material Input

NOTES:

- (1) b_w for hollow sections is the width of *ONE* web
- (2) Mild steel uses a bi-linear hardening model (hardening ratio: $b = E_{sh} / E_s$)
- (3) Prestressed / Post-Tensioned steel uses the Menegotto-Pinto model
- (4) Axial load is applied through the center of gravity of the section (c.g.c), ie no additional moment
- (5) Compressive force, stress, and strain are positive, tensile is negative (except in material definition)

Geometry

h =	12	in
h_{top} =		in
h_{bot} =		in
b_w =	80	in
b_{top} =		in
b_{bot} =		in
Shape:	SOLID	

Concrete Material Properties

f'_c =	4	ksi
β_1 =	0.85	
ϵ_{cu} =	0.003	in/in

Mild Steel Material Properties

E_s =	29,000	ksi
f_y =	60	ksi
b =		

PS / PT Material Properties

E_p =	28,500	ksi
f_{pu} =	270	ksi
σ_o =	253.6	ksi
R =	7.48	
b =	0.0105	

Axial Load on Section

P_a =		kip
---------	--	-----

Total Prestress: 242.4 kip

Long. Steel Required for Torsion

$A_{l,t}$ =		in^2
-------------	--	--------

Cross Section

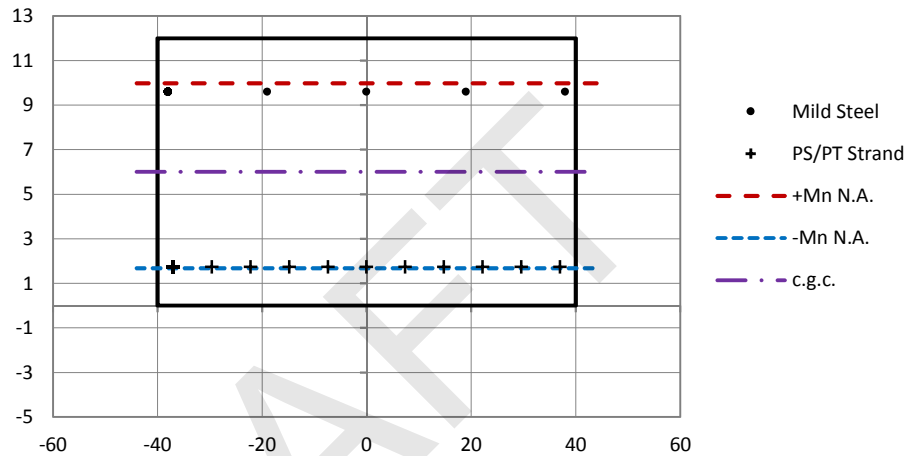

Steel Models

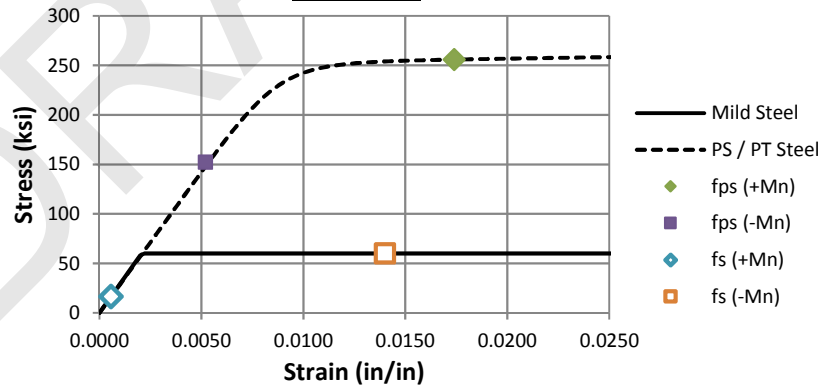

Mild Steel Locations

Layer	# bars	A_{bar} in^2	d_s in	Type
1	5	0.44	2.4	Main
2				
3				
4				
5				
6				
7				
8				
9				
10				
11				
12				

Prestressed / Post Tensioned Steel Locations

Layer	# strands	A_{strand} in^2	d_p in	f_{pe} ksi	Type
1	11	0.153	10.25	144	Bonded
2					
3					
4					
5					
6					
7					
8					
9					
10					
11					
12					



Client: City of San Diego
 Project: Ocean Beach Pier
 Design For: Deck Evaluation
Midspan - 5 Strands Missing

Job Number 9487
 Sheet 2 of 2
 Designer SJS Date _____
 Checker _____ Date _____

Positive Moment Capacity

NOTES:

- (1) Analysis of a reinforced concrete or prestressed beam per ACI 318-14 using strain compatibility
- (2) Positive stresses and strains are compressive, negative are tensile
- (3) Moments are calculated about the midheight of the cross section
- (4) The longitudinal steel area used for torsion is subtracted from each mild steel with *Type = Main* according to the ratio of $A_{l,torsion}$ to $A_{l,main}$. The area of steel with *Type = Skin* is not reduced for torsion, $A_{s,eff}$ is the effective area per layer including the reduction in steel area due to torsion.

POSITIVE MOMENT CAPACITY

Concrete Response

c	a	A_c	ϵ_c	f_c	C_c	M_c
in	in	in ²	in/in	ksi	kip	kip-in
2.02	1.72	137.3	0.003	4.00	467	2,400

Prestressed / Post-Tensioned Steel Response

Layer	d_p	Type	$A_{p,total}$	f_{pe}	$\epsilon_{p,prestress}$	$\epsilon_{p,axial}$	$\epsilon_{p,flex}$	$\epsilon_{p,total}$	f_{ps}	F_p	M_p
	in		in ²	ksi	in/in	in/in	in/in	in/in	ksi	kip	kip-in
1	10.25	Bonded	1.68	144	-0.0051	-0.00017	-0.0122	-0.0175	-255.9	-430.8	1,831
2											
3											
4											
5											
6											
7											
8											
9											
10											
11											
12											

Steel Response

Layer	d_s	# bars	Type	$A_{s,total}$	$A_{s,eff}$	$\epsilon_{s,flex}$	$\epsilon_{s,axial}$	$\epsilon_{s,total}$	f_s	F_s	M_s
	in			in ²	in ²	in/in	in/in	in/in	ksi	kip	kip-in
1	2.4	5	Main	2.20	2.20	-0.0006		-0.0006	-16.4	-36.1	-130
2											
3											
4											
5											
6											
7											
8											
9											
10											
11											
12											

Demand

$P_u =$ _____ kip
 $M_u =$ _____ kip-ft
 $\phi =$ 0.90 (ACI 21.2.2)

Reduced Moment Strength

$\Sigma M_{mid} =$ 342 kip-ft
 $\phi M_n =$ 307.6 kip-ft

$\Sigma F_s + \Sigma C_c = 0$ OK!

Flexural Strength Adequate!

Geometry and Material Input

NOTES:

- (1) b_w for hollow sections is the width of ONE web
- (2) Mild steel uses a bi-linear hardening model (hardening ratio: $b = E_{sh} / E_s$)
- (3) Prestressed / Post-Tensioned steel uses the Menegotto-Pinto model
- (4) Axial load is applied through the center of gravity of the section (c.g.c), ie no additional moment
- (5) Compressive force, stress, and strain are positive, tensile is negative (except in material definition)

Geometry

h =	12	in
h_{top} =		in
h_{bot} =		in
b_w =	80	in
b_{top} =		in
b_{bot} =		in
Shape:	SOLID	

Concrete Material Properties

f'_c =	4	ksi
β_1 =	0.85	
ϵ_{cu} =	0.003	in/in

Mild Steel Material Properties

E_s =	29,000	ksi
f_y =	60	ksi
b =		

PS / PT Material Properties

E_p =	28,500	ksi
f_{pu} =	270	ksi
σ_o =	253.6	ksi
R =	7.48	
b =	0.0105	

Axial Load on Section

P_a =		kip
---------	--	-----

Total Prestress: **220.3 kip**

Long. Steel Required for Torsion

$A_{l,t}$ =		in^2
-------------	--	--------

Cross Section

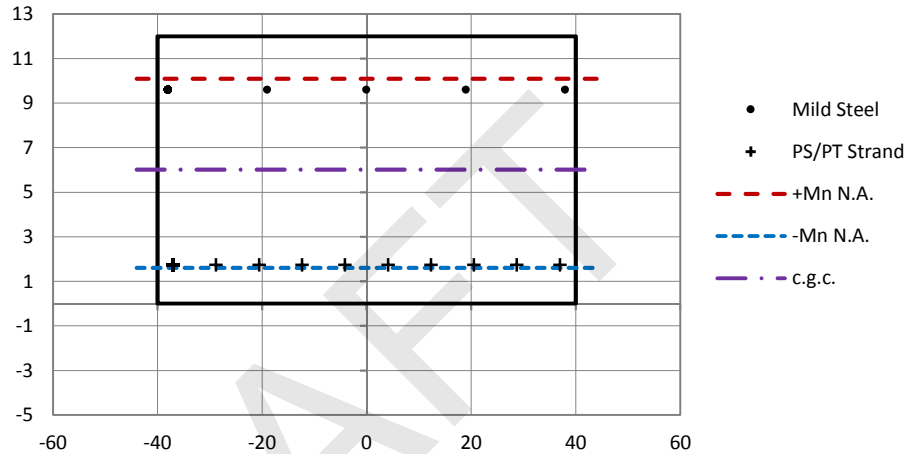

Steel Models

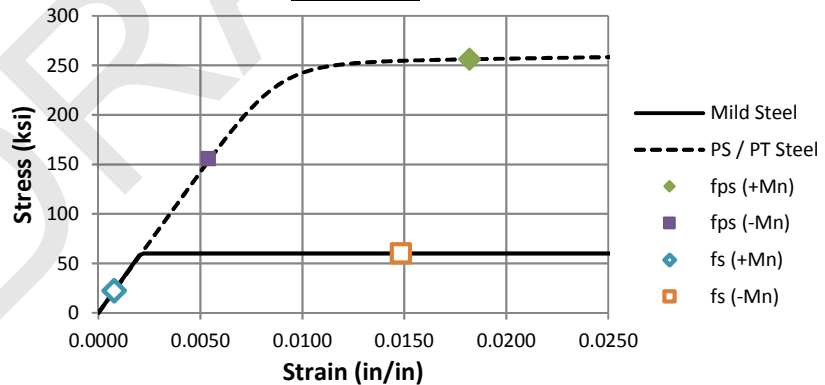

Mild Steel Locations

Layer	# bars	A_{bar} in^2	d_s in	Type
1	5	0.44	2.4	Main
2				
3				
4				
5				
6				
7				
8				
9				
10				
11				
12				

Prestressed / Post Tensioned Steel Locations

Layer	# strands	A_{strand} in^2	d_p in	f_{pe} ksi	Type
1	10	0.153	10.25	144	Bonded
2					
3					
4					
5					
6					
7					
8					
9					
10					
11					
12					



Client: City of San Diego
 Project: Ocean Beach Pier
 Design For: Deck Evaluation
Midspan - 6 Strands Missing

Job Number 9487
 Sheet 2 of 2
 Designer SJS Date _____
 Checker _____ Date _____

Positive Moment Capacity

NOTES:

- (1) Analysis of a reinforced concrete or prestressed beam per ACI 318-14 using strain compatibility
- (2) Positive stresses and strains are compressive, negative are tensile
- (3) Moments are calculated about the midheight of the cross section
- (4) The longitudinal steel area used for torsion is subtracted from each mild steel with *Type = Main* according to the ratio of $A_{l,torsion}$ to $A_{l,main}$. The area of steel with *Type = Skin* is not reduced for torsion, $A_{s,eff}$ is the effective area per layer including the reduction in steel area due to torsion.

POSITIVE MOMENT CAPACITY

Concrete Response

c	a	A_c	ϵ_c	f_c	C_c	M_c
in	in	in ²	in/in	ksi	kip	kip-in
1.91	1.62	129.8	0.003	4.00	441	2,290

Prestressed / Post-Tensioned Steel Response

Layer	d_p	Type	$A_{p,total}$	f_{pe}	$\epsilon_{p,prestess}$	$\epsilon_{p,axial}$	$\epsilon_{p,flex}$	$\epsilon_{p,total}$	f_{ps}	F_p	M_p
	in		in ²	ksi	in/in	in/in	in/in	in/in	ksi	kip	kip-in
1	10.25	Bonded	1.53	144	-0.0051	-0.00016	-0.0131	-0.0183	-256.3	-392.1	1,666
2											
3											
4											
5											
6											
7											
8											
9											
10											
11											
12											

Steel Response

Layer	d_s	# bars	Type	$A_{s,total}$	$A_{s,eff}$	$\epsilon_{s,flex}$	$\epsilon_{s,axial}$	$\epsilon_{s,total}$	f_s	F_s	M_s
	in			in ²	in ²	in/in	in/in	in/in	ksi	kip	kip-in
1	2.4	5	Main	2.20	2.20	-0.0008		-0.0008	-22.4	-49.2	-177
2											
3											
4											
5											
6											
7											
8											
9											
10											
11											
12											

Demand

$P_u =$ _____ kip
 $M_u =$ _____ kip-ft
 $\phi =$ 0.90 (ACI 21.2.2)

Reduced Moment Strength

$\Sigma M_{mid} =$ 315 kip-ft
 $\phi M_n =$ 283.4 kip-ft

$\Sigma F_s + \Sigma C_c = 0$ OK!

Flexural Strength Adequate!

Geometry and Material Input

NOTES:

- (1) b_w for hollow sections is the width of ONE web
- (2) Mild steel uses a bi-linear hardening model (hardening ratio: $b = E_{sh} / E_s$)
- (3) Prestressed / Post-Tensioned steel uses the Menegotto-Pinto model
- (4) Axial load is applied through the center of gravity of the section (c.g.c), ie no additional moment
- (5) Compressive force, stress, and strain are positive, tensile is negative (except in material definition)

Geometry

h =	12	in
h_{top} =		in
h_{bot} =		in
b_w =	80	in
b_{top} =		in
b_{bot} =		in
Shape:	SOLID	

Concrete Material Properties

f'_c =	4	ksi
β_1 =	0.85	
ϵ_{cu} =	0.003	in/in

Mild Steel Material Properties

E_s =	29,000	ksi
f_y =	60	ksi
b =		

PS / PT Material Properties

E_p =	28,500	ksi
f_{pu} =	270	ksi
σ_o =	253.6	ksi
R =	7.48	
b =	0.0105	

Axial Load on Section

P_a =		kip
---------	--	-----

Total Prestress: **198.3 kip**

Long. Steel Required for Torsion

$A_{l,t}$ =		in^2
-------------	--	--------

Cross Section

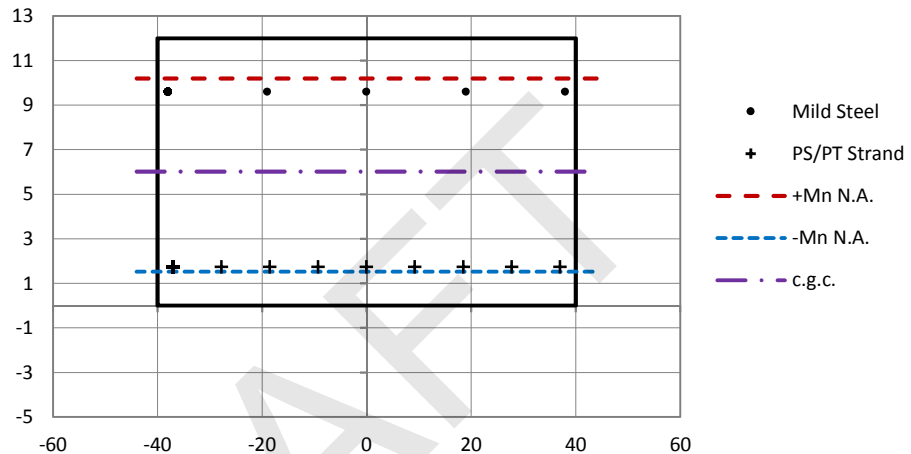

Steel Models

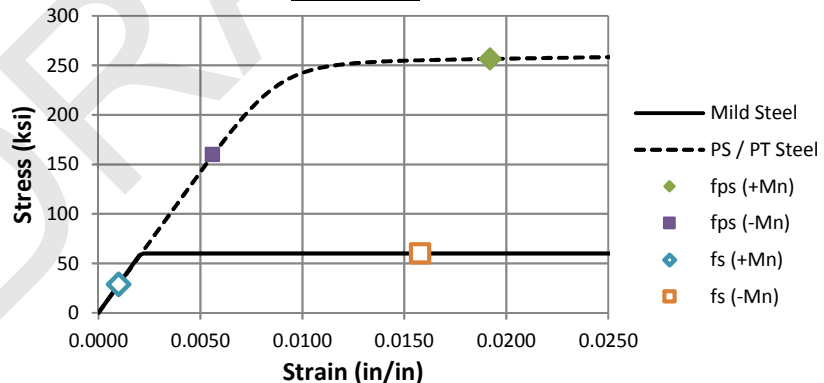

Mild Steel Locations

Layer	# bars	A_{bar} in^2	d_s in	Type
1	5	0.44	2.4	Main
2				
3				
4				
5				
6				
7				
8				
9				
10				
11				
12				

Prestressed / Post Tensioned Steel Locations

Layer	# strands	A_{strand} in^2	d_p in	f_{pe} ksi	Type
1	9	0.153	10.25	144	Bonded
2					
3					
4					
5					
6					
7					
8					
9					
10					
11					
12					



Client: City of San Diego
 Project: Ocean Beach Pier
 Design For: Deck Evaluation
Midspan - 7 Strands Missing

Job Number 9487
 Sheet 2 of 2
 Designer SJS Date _____
 Checker _____ Date _____

Positive Moment Capacity

NOTES:

- (1) Analysis of a reinforced concrete or prestressed beam per ACI 318-14 using strain compatibility
- (2) Positive stresses and strains are compressive, negative are tensile
- (3) Moments are calculated about the midheight of the cross section
- (4) The longitudinal steel area used for torsion is subtracted from each mild steel with *Type = Main* according to the ratio of $A_{l,torsion}$ to $A_{l,main}$. The area of steel with *Type = Skin* is not reduced for torsion, $A_{s,eff}$ is the effective area per layer including the reduction in steel area due to torsion.

POSITIVE MOMENT CAPACITY

Concrete Response

c	a	A_c	ϵ_c	f_c	C_c	M_c
in	in	in ²	in/in	ksi	kip	kip-in
1.80	1.53	122.6	0.003	4.00	417	2,181

Prestressed / Post-Tensioned Steel Response

Layer	d_p	Type	$A_{p,total}$	f_{pe}	$\epsilon_{p,prestress}$	$\epsilon_{p,axial}$	$\epsilon_{p,flex}$	$\epsilon_{p,total}$	f_{ps}	F_p	M_p
	in		in ²	ksi	in/in	in/in	in/in	in/in	ksi	kip	kip-in
1	10.25	Bonded	1.38	144	-0.0051	-0.00014	-0.0141	-0.0193	-256.6	-353.3	1,502
2											
3											
4											
5											
6											
7											
8											
9											
10											
11											
12											

Steel Response

Layer	d_s	# bars	Type	$A_{s,total}$	$A_{s,eff}$	$\epsilon_{s,flex}$	$\epsilon_{s,axial}$	$\epsilon_{s,total}$	f_s	F_s	M_s
	in			in ²	in ²	in/in	in/in	in/in	ksi	kip	kip-in
1	2.4	5	Main	2.20	2.20	-0.0010		-0.0010	-28.8	-63.4	-228
2											
3											
4											
5											
6											
7											
8											
9											
10											
11											
12											

Demand

$P_u =$ _____ kip
 $M_u =$ _____ kip-ft
 $\phi =$ 0.90 (ACI 21.2.2)

Reduced Moment Strength

$\Sigma M_{mid} =$ 288 kip-ft
 $\phi M_n =$ 259.1 kip-ft

$\Sigma F_s + \Sigma C_c = 0$ OK!

Flexural Strength Adequate!

Geometry and Material Input

NOTES:

- (1) b_w for hollow sections is the width of ONE web
- (2) Mild steel uses a bi-linear hardening model (hardening ratio: $b = E_{sh} / E_s$)
- (3) Prestressed / Post-Tensioned steel uses the Menegotto-Pinto model
- (4) Axial load is applied through the center of gravity of the section (c.g.c), ie no additional moment
- (5) Compressive force, stress, and strain are positive, tensile is negative (except in material definition)

Geometry

h =	12	in
h_{top} =		in
h_{bot} =		in
b_w =	80	in
b_{top} =		in
b_{bot} =		in
Shape:	SOLID	

Concrete Material Properties

f'_c =	4	ksi
β_1 =	0.85	
ϵ_{cu} =	0.003	in/in

Mild Steel Material Properties

E_s =	29,000	ksi
f_y =	60	ksi
b =		

PS / PT Material Properties

E_p =	28,500	ksi
f_{pu} =	270	ksi
σ_o =	253.6	ksi
R =	7.48	
b =	0.0105	

Axial Load on Section

P_a =		kip
---------	--	-----

Total Prestress: 176.3 kip

Long. Steel Required for Torsion

$A_{l,t}$ =		in^2
-------------	--	--------

Cross Section

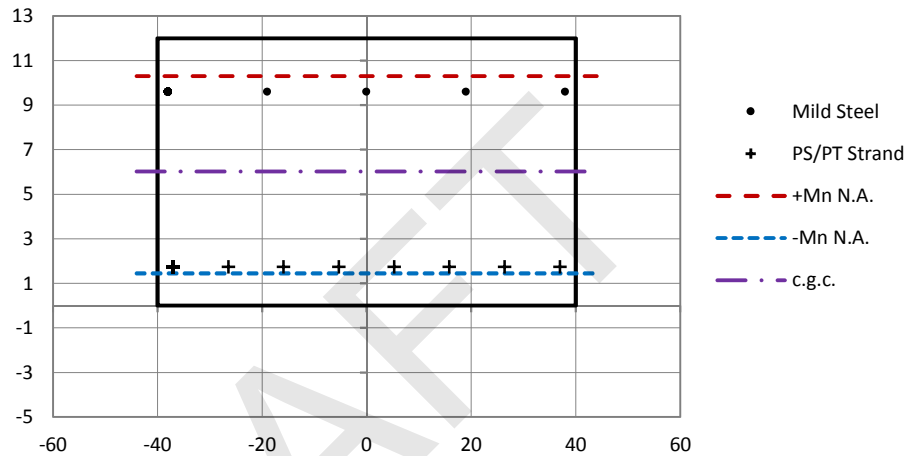

Steel Models

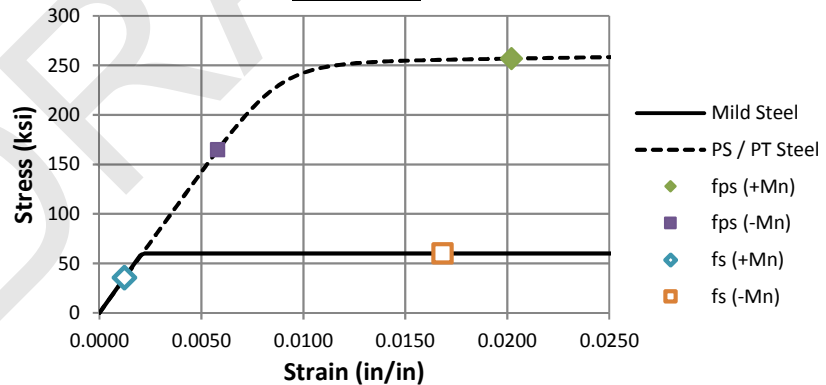

Mild Steel Locations

Layer	# bars	A_{bar} in^2	d_s in	Type
1	5	0.44	2.4	Main
2				
3				
4				
5				
6				
7				
8				
9				
10				
11				
12				

Prestressed / Post Tensioned Steel Locations

Layer	# strands	A_{strand} in^2	d_p in	f_{pe} ksi	Type
1	8	0.153	10.25	144	Bonded
2					
3					
4					
5					
6					
7					
8					
9					
10					
11					
12					



Client: City of San Diego
 Project: Ocean Beach Pier
 Design For: Deck Evaluation
Midspan - 8 Strands Missing

Job Number 9487
 Sheet 2 of 2
 Designer SJS Date _____
 Checker _____ Date _____

Positive Moment Capacity

NOTES:

- (1) Analysis of a reinforced concrete or prestressed beam per ACI 318-14 using strain compatibility
- (2) Positive stresses and strains are compressive, negative are tensile
- (3) Moments are calculated about the midheight of the cross section
- (4) The longitudinal steel area used for torsion is subtracted from each mild steel with *Type = Main* according to the ratio of $A_{l,torsion}$ to $A_{l,main}$. The area of steel with *Type = Skin* is not reduced for torsion, $A_{s,eff}$ is the effective area per layer including the reduction in steel area due to torsion.

POSITIVE MOMENT CAPACITY

Concrete Response

c	a	A_c	ϵ_c	f_c	C_c	M_c
in	in	in ²	in/in	ksi	kip	kip-in
1.70	1.45	115.6	0.003	4.00	393	2,075

Prestressed / Post-Tensioned Steel Response

Layer	d_p	Type	$A_{p,total}$	f_{pe}	$\epsilon_{p,prestress}$	$\epsilon_{p,axial}$	$\epsilon_{p,flex}$	$\epsilon_{p,total}$	f_{ps}	F_p	M_p
	in		in ²	ksi	in/in	in/in	in/in	in/in	ksi	kip	kip-in
1	10.25	Bonded	1.22	144	-0.0051	-0.00013	-0.0151	-0.0203	-256.9	-314.5	1,337
2											
3											
4											
5											
6											
7											
8											
9											
10											
11											
12											

Steel Response

Layer	d_s	# bars	Type	$A_{s,total}$	$A_{s,eff}$	$\epsilon_{s,flex}$	$\epsilon_{s,axial}$	$\epsilon_{s,total}$	f_s	F_s	M_s
	in			in ²	in ²	in/in	in/in	in/in	ksi	kip	kip-in
1	2.4	5	Main	2.20	2.20	-0.0012		-0.0012	-35.8	-78.7	-283
2											
3											
4											
5											
6											
7											
8											
9											
10											
11											
12											

Demand

$P_u =$ _____ kip
 $M_u =$ _____ kip-ft
 $\phi =$ 0.90 (ACI 21.2.2)

Reduced Moment Strength

$\Sigma M_{mid} =$ 261 kip-ft
 $\phi M_n =$ 234.6 kip-ft

$\Sigma F_s + \Sigma C_c = 0$ OK!

Flexural Strength Adequate!

Geometry and Material Input

NOTES:

- (1) b_w for hollow sections is the width of *ONE* web
- (2) Mild steel uses a bi-linear hardening model (hardening ratio: $b = E_{sh} / E_s$)
- (3) Prestressed / Post-Tensioned steel uses the Menegotto-Pinto model
- (4) Axial load is applied through the center of gravity of the section (c.g.c), ie no additional moment
- (5) Compressive force, stress, and strain are positive, tensile is negative (except in material definition)

Geometry

h =	12	in
h_{top} =		in
h_{bot} =		in
b_w =	80	in
b_{top} =		in
b_{bot} =		in
Shape:	SOLID	

Concrete Material Properties

f'_c =	4	ksi
β_1 =	0.85	
ϵ_{cu} =	0.003	in/in

Mild Steel Material Properties

E_s =	29,000	ksi
f_y =	60	ksi
b =		

PS / PT Material Properties

E_p =	28,500	ksi
f_{pu} =	270	ksi
σ_o =	253.6	ksi
R =	7.48	
b =	0.0105	

Axial Load on Section

P_a =		kip
---------	--	-----

Total Prestress: **154.2 kip**

Long. Steel Required for Torsion

$A_{l,t}$ =		in^2
-------------	--	--------

Cross Section

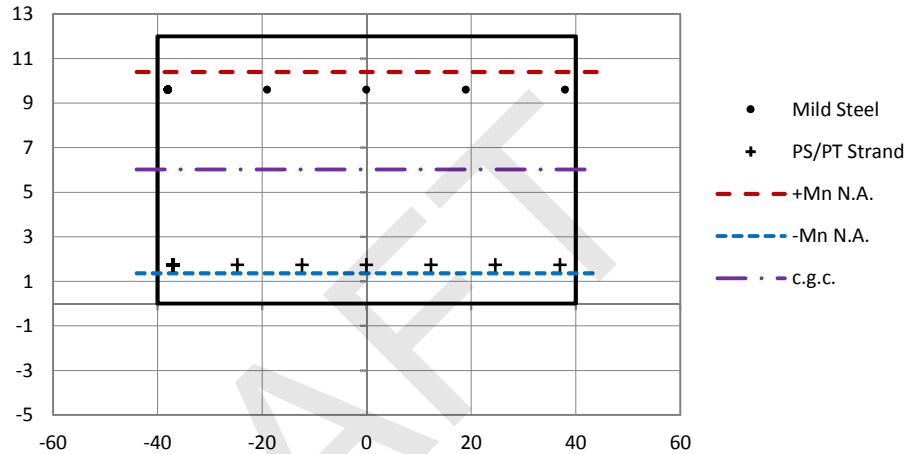

Steel Models

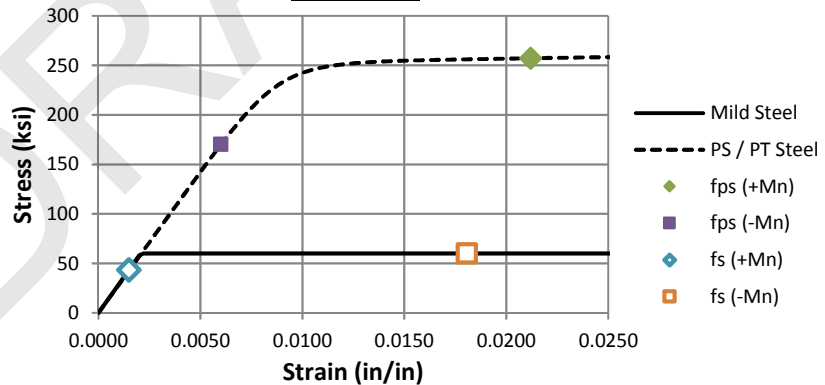

Mild Steel Locations

Layer	# bars	A_{bar} in^2	d_s in	Type
1	5	0.44	2.4	Main
2				
3				
4				
5				
6				
7				
8				
9				
10				
11				
12				

Prestressed / Post Tensioned Steel Locations

Layer	# strands	A_{strand} in^2	d_p in	f_{pe} ksi	Type
1	7	0.153	10.25	144	Bonded
2					
3					
4					
5					
6					
7					
8					
9					
10					
11					
12					



Client: City of San Diego
 Project: Ocean Beach Pier
 Design For: Deck Evaluation
Midspan - 9 Strands Missing

Job Number 9487
 Sheet 2 of 2
 Designer SJS Date _____
 Checker _____ Date _____

Positive Moment Capacity

NOTES:

- (1) Analysis of a reinforced concrete or prestressed beam per ACI 318-14 using strain compatibility
- (2) Positive stresses and strains are compressive, negative are tensile
- (3) Moments are calculated about the midheight of the cross section
- (4) The longitudinal steel area used for torsion is subtracted from each mild steel with *Type = Main* according to the ratio of $A_{l,torsion}$ to $A_{l,main}$. The area of steel with *Type = Skin* is not reduced for torsion, $A_{s,eff}$ is the effective area per layer including the reduction in steel area due to torsion.

POSITIVE MOMENT CAPACITY

Concrete Response

c	a	A_c	ϵ_c	f_c	C_c	M_c
in	in	in ²	in/in	ksi	kip	kip-in
1.60	1.36	109.0	0.003	4.00	371	1,971

Prestressed / Post-Tensioned Steel Response

Layer	d_p	Type	$A_{p,total}$	f_{pe}	$\epsilon_{p,prestress}$	$\epsilon_{p,axial}$	$\epsilon_{p,flex}$	$\epsilon_{p,total}$	f_{ps}	F_p	M_p
	in		in ²	ksi	in/in	in/in	in/in	in/in	ksi	kip	kip-in
1	10.25	Bonded	1.07	144	-0.0051	-0.00011	-0.0162	-0.0213	-257.3	-275.5	1,171
2											
3											
4											
5											
6											
7											
8											
9											
10											
11											
12											

Steel Response

Layer	d_s	# bars	Type	$A_{s,total}$	$A_{s,eff}$	$\epsilon_{s,flex}$	$\epsilon_{s,axial}$	$\epsilon_{s,total}$	f_s	F_s	M_s
	in			in ²	in ²	in/in	in/in	in/in	ksi	kip	kip-in
1	2.4	5	Main	2.20	2.20	-0.0015		-0.0015	-43.2	-95.1	-342
2											
3											
4											
5											
6											
7											
8											
9											
10											
11											
12											

Demand

$P_u =$ _____ kip
 $M_u =$ _____ kip-ft
 $\phi =$ 0.90 (ACI 21.2.2)

Reduced Moment Strength

$\Sigma M_{mid} =$ 233 kip-ft
 $\phi M_n =$ 210.0 kip-ft

$\Sigma F_s + \Sigma C_c = 0$ OK!

Flexural Strength Adequate!

Geometry and Material Input

NOTES:

- (1) b_w for hollow sections is the width of ONE web
- (2) Mild steel uses a bi-linear hardening model (hardening ratio: $b = E_{sh} / E_s$)
- (3) Prestressed / Post-Tensioned steel uses the Menegotto-Pinto model
- (4) Axial load is applied through the center of gravity of the section (c.g.c), ie no additional moment
- (5) Compressive force, stress, and strain are positive, tensile is negative (except in material definition)

Geometry

h =	12	in
h_{top} =		in
h_{bot} =		in
b_w =	80	in
b_{top} =		in
b_{bot} =		in
Shape:	SOLID	

Concrete Material Properties

f'_c =	4	ksi
β_1 =	0.85	
ϵ_{cu} =	0.003	in/in

Mild Steel Material Properties

E_s =	29,000	ksi
f_y =	60	ksi
b =		

PS / PT Material Properties

E_p =	28,500	ksi
f_{pu} =	270	ksi
σ_o =	253.6	ksi
R =	7.48	
b =	0.0105	

Axial Load on Section

P_a =		kip
---------	--	-----

Total Prestress: 132.2 kip

Long. Steel Required for Torsion

$A_{l,t}$ =		in^2
-------------	--	--------

Cross Section

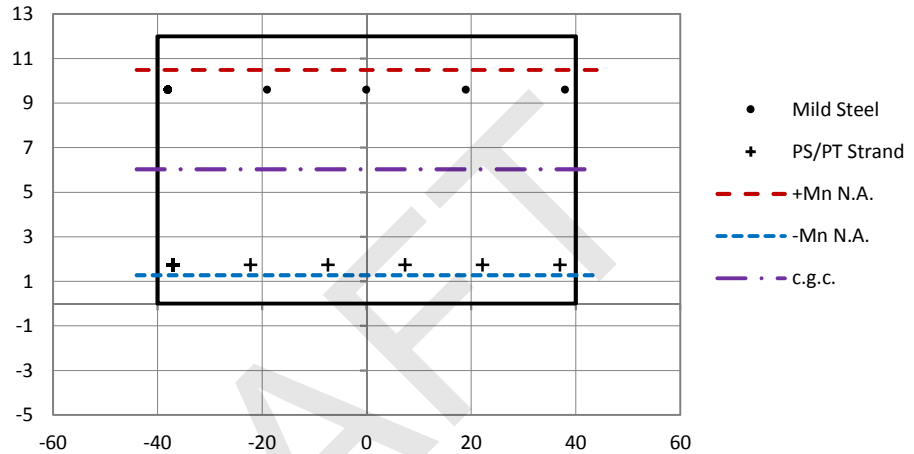

Steel Models

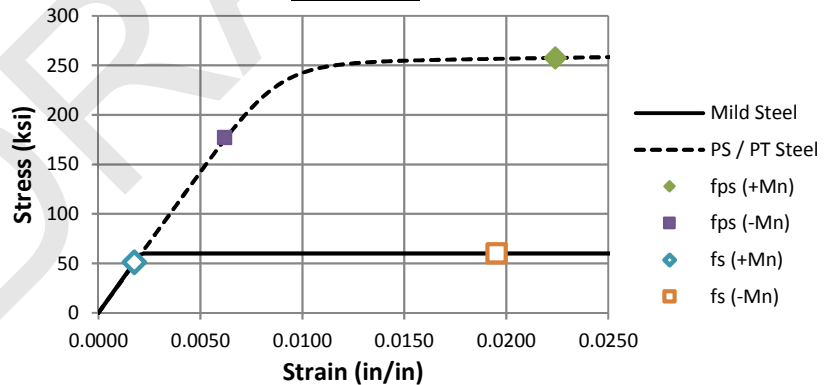

Mild Steel Locations

Layer	# bars	A_{bar} in^2	d_s in	Type
1	5	0.44	2.4	Main
2				
3				
4				
5				
6				
7				
8				
9				
10				
11				
12				

Prestressed / Post Tensioned Steel Locations

Layer	# strands	A_{strand} in^2	d_p in	f_{pe} ksi	Type
1	6	0.153	10.25	144	Bonded
2					
3					
4					
5					
6					
7					
8					
9					
10					
11					
12					



Client: City of San Diego
 Project: Ocean Beach Pier
 Design For: Deck Evaluation
Midspan - 10 Strands Missing

Job Number 9487
 Sheet 2 of 2
 Designer SJS Date _____
 Checker _____ Date _____

Positive Moment Capacity

NOTES:

- (1) Analysis of a reinforced concrete or prestressed beam per ACI 318-14 using strain compatibility
- (2) Positive stresses and strains are compressive, negative are tensile
- (3) Moments are calculated about the midheight of the cross section
- (4) The longitudinal steel area used for torsion is subtracted from each mild steel with *Type = Main* according to the ratio of $A_{l,torsion}$ to $A_{l,main}$. The area of steel with *Type = Skin* is not reduced for torsion, $A_{s,eff}$ is the effective area per layer including the reduction in steel area due to torsion.

POSITIVE MOMENT CAPACITY

Concrete Response

c	a	A_c	ϵ_c	f_c	C_c	M_c
in	in	in ²	in/in	ksi	kip	kip-in
1.51	1.28	102.7	0.003	4.00	349	1,871

Prestressed / Post-Tensioned Steel Response

Layer	d_p	Type	$A_{p,total}$	f_{pe}	$\epsilon_{p,prestress}$	$\epsilon_{p,axial}$	$\epsilon_{p,flex}$	$\epsilon_{p,total}$	f_{ps}	F_p	M_p
	in		in ²	ksi	in/in	in/in	in/in	in/in	ksi	kip	kip-in
1	10.25	Bonded	0.92	144	-0.0051	-0.00009	-0.0174	-0.0225	-257.6	-236.5	1,005
2											
3											
4											
5											
6											
7											
8											
9											
10											
11											
12											

Steel Response

Layer	d_s	# bars	Type	$A_{s,total}$	$A_{s,eff}$	$\epsilon_{s,flex}$	$\epsilon_{s,axial}$	$\epsilon_{s,total}$	f_s	F_s	M_s
	in			in ²	in ²	in/in	in/in	in/in	ksi	kip	kip-in
1	2.4	5	Main	2.20	2.20	-0.0018		-0.0018	-51.2	-112.7	-406
2											
3											
4											
5											
6											
7											
8											
9											
10											
11											
12											

Demand

$P_u =$ _____ kip
 $M_u =$ _____ kip-ft
 $\phi =$ 0.90 (ACI 21.2.2)

Reduced Moment Strength

$\Sigma M_{mid} =$ 206 kip-ft
 $\phi M_n =$ 185.3 kip-ft

$\Sigma F_s + \Sigma C_c = 0$ OK!

Flexural Strength Adequate!

Geometry and Material Input

NOTES:

- (1) b_w for hollow sections is the width of ONE web
- (2) Mild steel uses a bi-linear hardening model (hardening ratio: $b = E_{sh} / E_s$)
- (3) Prestressed / Post-Tensioned steel uses the Menegotto-Pinto model
- (4) Axial load is applied through the center of gravity of the section (c.g.c), ie no additional moment
- (5) Compressive force, stress, and strain are positive, tensile is negative (except in material definition)

Geometry

h =	12	in
h_{top} =		in
h_{bot} =		in
b_w =	80	in
b_{top} =		in
b_{bot} =		in
Shape:	SOLID	

Concrete Material Properties

f'_c =	4	ksi
β_1 =	0.85	
ϵ_{cu} =	0.003	in/in

Mild Steel Material Properties

E_s =	29,000	ksi
f_y =	60	ksi
b =		

PS / PT Material Properties

E_p =	28,500	ksi
f_{pu} =	270	ksi
σ_o =	253.6	ksi
R =	7.48	
b =	0.0105	

Axial Load on Section

P_a =		kip
---------	--	-----

Total Prestress: 110.2 kip

Long. Steel Required for Torsion

$A_{l,t}$ =		in^2
-------------	--	--------

Cross Section

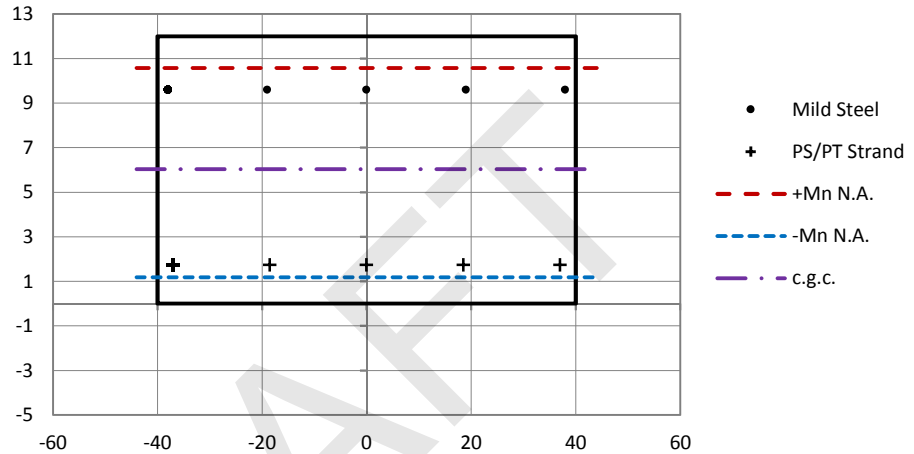

Steel Models

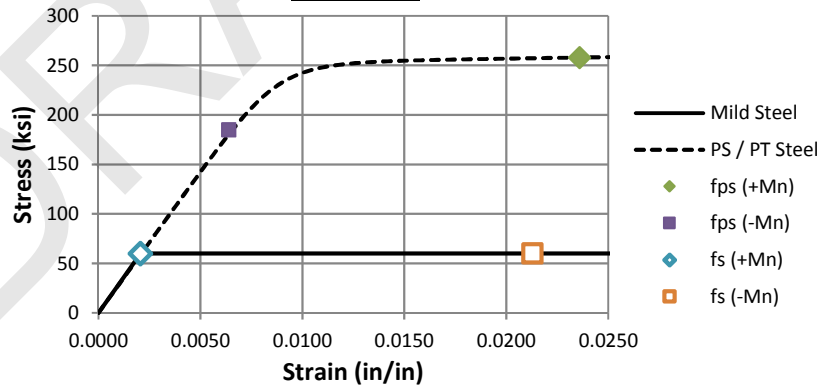

Mild Steel Locations

Layer	# bars	A_{bar} in^2	d_s in	Type
1	5	0.44	2.4	Main
2				
3				
4				
5				
6				
7				
8				
9				
10				
11				
12				

Prestressed / Post Tensioned Steel Locations

Layer	# strands	A_{strand} in^2	d_p in	f_{pe} ksi	Type
1	5	0.153	10.25	144	Bonded
2					
3					
4					
5					
6					
7					
8					
9					
10					
11					
12					



Client: City of San Diego
 Project: Ocean Beach Pier
 Design For: Deck Evaluation
Midspan - 11 Strands Missing

Job Number 9487
 Sheet 2 of 2
 Designer SJS Date _____
 Checker _____ Date _____

Positive Moment Capacity

NOTES:

- (1) Analysis of a reinforced concrete or prestressed beam per ACI 318-14 using strain compatibility
- (2) Positive stresses and strains are compressive, negative are tensile
- (3) Moments are calculated about the midheight of the cross section
- (4) The longitudinal steel area used for torsion is subtracted from each mild steel with *Type = Main* according to the ratio of $A_{l,torsion}$ to $A_{l,main}$. The area of steel with *Type = Skin* is not reduced for torsion, $A_{s,eff}$ is the effective area per layer including the reduction in steel area due to torsion.

POSITIVE MOMENT CAPACITY

Concrete Response

c	a	A_c	ϵ_c	f_c	C_c	M_c
in	in	in ²	in/in	ksi	kip	kip-in
1.42	1.21	96.7	0.003	4.00	329	1,775

Prestressed / Post-Tensioned Steel Response

Layer	d_p	Type	$A_{p,total}$	f_{pe}	$\epsilon_{p,prestress}$	$\epsilon_{p,axial}$	$\epsilon_{p,flex}$	$\epsilon_{p,total}$	f_{ps}	F_p	M_p
	in		in ²	ksi	in/in	in/in	in/in	in/in	ksi	kip	kip-in
1	10.25	Bonded	0.77	144	-0.0051	-0.00008	-0.0186	-0.0237	-258.0	-197.4	839
2											
3											
4											
5											
6											
7											
8											
9											
10											
11											
12											

Steel Response

Layer	d_s	# bars	Type	$A_{s,total}$	$A_{s,eff}$	$\epsilon_{s,flex}$	$\epsilon_{s,axial}$	$\epsilon_{s,total}$	f_s	F_s	M_s
	in			in ²	in ²	in/in	in/in	in/in	ksi	kip	kip-in
1	2.4	5	Main	2.20	2.20	-0.0021		-0.0021	-59.8	-131.5	-473
2											
3											
4											
5											
6											
7											
8											
9											
10											
11											
12											

Demand

$P_u =$ _____ kip
 $M_u =$ _____ kip-ft
 $\phi =$ 0.90 (ACI 21.2.2)

Reduced Moment Strength

$\Sigma M_{mid} =$ 178 kip-ft
 $\phi M_n =$ 160.5 kip-ft

$\Sigma F_s + \Sigma C_c = 0$ OK!

Flexural Strength Adequate!

Geometry and Material Input

NOTES:

- (1) b_w for hollow sections is the width of ONE web
- (2) Mild steel uses a bi-linear hardening model (hardening ratio: $b = E_{sh} / E_s$)
- (3) Prestressed / Post-Tensioned steel uses the Menegotto-Pinto model
- (4) Axial load is applied through the center of gravity of the section (c.g.c), ie no additional moment
- (5) Compressive force, stress, and strain are positive, tensile is negative (except in material definition)

Geometry

h =	12	in
h_{top} =		in
h_{bot} =		in
b_w =	80	in
b_{top} =		in
b_{bot} =		in
Shape:	SOLID	

Concrete Material Properties

f'_c =	4	ksi
β_1 =	0.85	
ϵ_{cu} =	0.003	in/in

Mild Steel Material Properties

E_s =	29,000	ksi
f_y =	60	ksi
b =		

PS / PT Material Properties

E_p =	28,500	ksi
f_{pu} =	270	ksi
σ_o =	253.6	ksi
R =	7.48	
b =	0.0105	

Axial Load on Section

P_a =		kip
---------	--	-----

Total Prestress: **88.1 kip**

Long. Steel Required for Torsion

$A_{l,t}$ =		in^2
-------------	--	--------

Cross Section

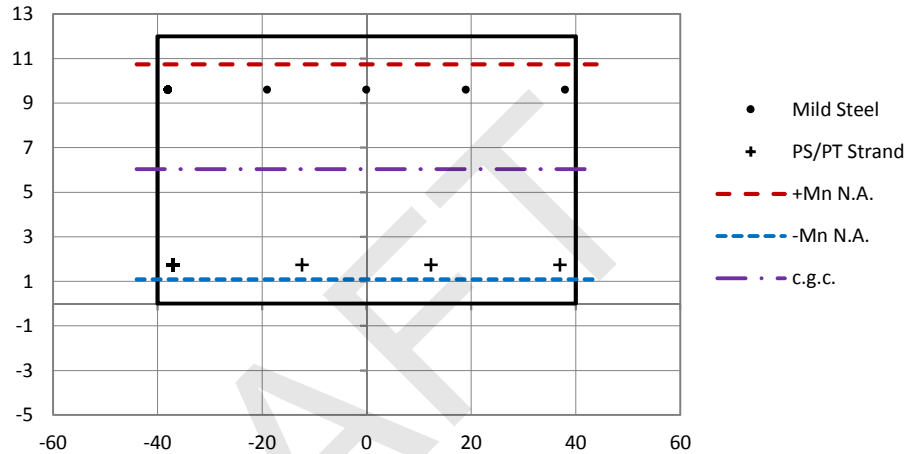

Steel Models

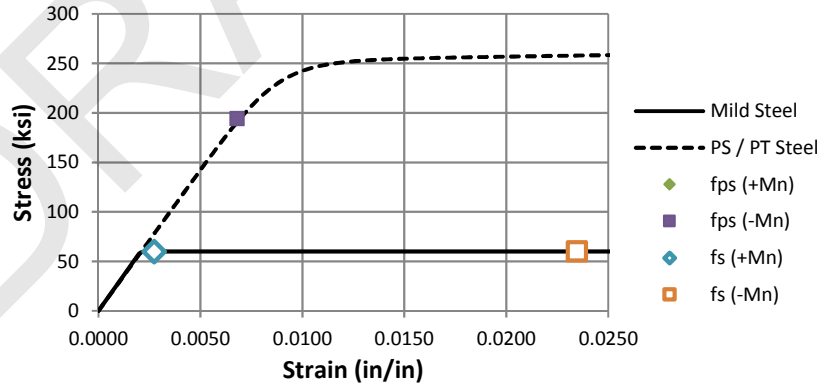

Mild Steel Locations

Layer	# bars	A_{bar} in^2	d_s in	Type
1	5	0.44	2.4	Main
2				
3				
4				
5				
6				
7				
8				
9				
10				
11				
12				

Prestressed / Post Tensioned Steel Locations

Layer	# strands	A_{strand} in^2	d_p in	f_{pe} ksi	Type
1	4	0.153	10.25	144	Bonded
2					
3					
4					
5					
6					
7					
8					
9					
10					
11					
12					



Client: City of San Diego
 Project: Ocean Beach Pier
 Design For: Deck Evaluation
Midspan - 12 Strands Missing

Job Number 9487
 Sheet 2 of 2
 Designer SJS Date _____
 Checker _____ Date _____

Positive Moment Capacity

NOTES:

- (1) Analysis of a reinforced concrete or prestressed beam per ACI 318-14 using strain compatibility
- (2) Positive stresses and strains are compressive, negative are tensile
- (3) Moments are calculated about the midheight of the cross section
- (4) The longitudinal steel area used for torsion is subtracted from each mild steel with *Type = Main* according to the ratio of $A_{l,torsion}$ to $A_{l,main}$. The area of steel with *Type = Skin* is not reduced for torsion, $A_{s,eff}$ is the effective area per layer including the reduction in steel area due to torsion.

POSITIVE MOMENT CAPACITY

Concrete Response

c	a	A_c	ϵ_c	f_c	C_c	M_c
in	in	in ²	in/in	ksi	kip	kip-in
1.26	1.07	85.4	0.003	4.00	290	1,588

Prestressed / Post-Tensioned Steel Response

Layer	d_p	Type	$A_{p,total}$	f_{pe}	$\epsilon_{p,prestress}$	$\epsilon_{p,axial}$	$\epsilon_{p,flex}$	$\epsilon_{p,total}$	f_{ps}	F_p	M_p
	in		in ²	ksi	in/in	in/in	in/in	in/in	ksi	kip	kip-in
1	10.25	Bonded	0.61	144	-0.0051	-0.00006	-0.0215	-0.0266	-258.9	-158.4	673
2											
3											
4											
5											
6											
7											
8											
9											
10											
11											
12											

Steel Response

Layer	d_s	# bars	Type	$A_{s,total}$	$A_{s,eff}$	$\epsilon_{s,flex}$	$\epsilon_{s,axial}$	$\epsilon_{s,total}$	f_s	F_s	M_s
	in			in ²	in ²	in/in	in/in	in/in	ksi	kip	kip-in
1	2.4	5	Main	2.20	2.20	-0.0027		-0.0027	-60.0	-132.0	-475
2											
3											
4											
5											
6											
7											
8											
9											
10											
11											
12											

Demand

$P_u =$ _____ kip
 $M_u =$ _____ kip-ft
 $\phi =$ 0.90 (ACI 21.2.2)

Reduced Moment Strength

$\Sigma M_{mid} =$ 149 kip-ft
 $\phi M_n =$ 133.9 kip-ft

$\Sigma F_s + \Sigma C_c = 0$ OK!

Flexural Strength Adequate!

Geometry and Material Input

NOTES:

- (1) b_w for hollow sections is the width of *ONE* web
- (2) Mild steel uses a bi-linear hardening model (hardening ratio: $b = E_{sh} / E_s$)
- (3) Prestressed / Post-Tensioned steel uses the Menegotto-Pinto model
- (4) Axial load is applied through the center of gravity of the section (c.g.c), ie no additional moment
- (5) Compressive force, stress, and strain are positive, tensile is negative (except in material definition)

Geometry

h =	12	in
h_{top} =		in
h_{bot} =		in
b_w =	80	in
b_{top} =		in
b_{bot} =		in
Shape:	SOLID	

Concrete Material Properties

f'_c =	4	ksi
β_1 =	0.85	
ϵ_{cu} =	0.003	in/in

Mild Steel Material Properties

E_s =	29,000	ksi
f_y =	60	ksi
b =		

PS / PT Material Properties

E_p =	28,500	ksi
f_{pu} =	270	ksi
σ_o =	253.6	ksi
R =	7.48	
b =	0.0105	

Axial Load on Section

P_a =		kip
---------	--	-----

Total Prestress: **66.1 kip**

Long. Steel Required for Torsion

$A_{l,t}$ =		in^2
-------------	--	--------

Cross Section

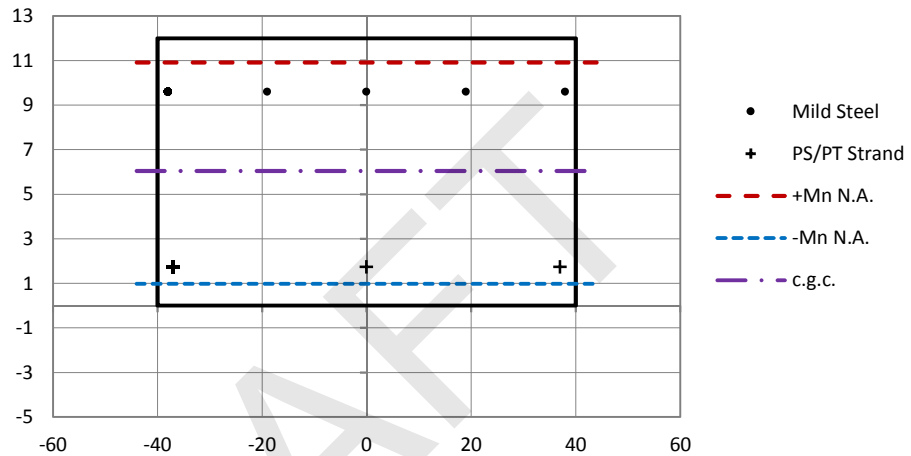

Steel Models

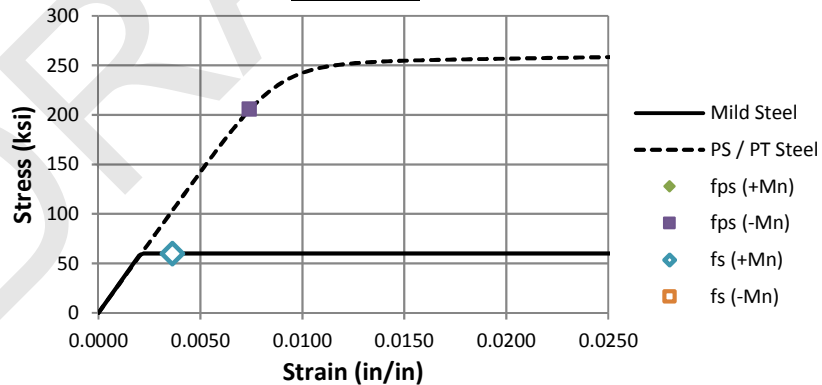

Mild Steel Locations

Layer	# bars	A_{bar} in^2	d_s in	Type
1	5	0.44	2.4	Main
2				
3				
4				
5				
6				
7				
8				
9				
10				
11				
12				

Prestressed / Post Tensioned Steel Locations

Layer	# strands	A_{strand} in^2	d_p in	f_{pe} ksi	Type
1	3	0.153	10.25	144	Bonded
2					
3					
4					
5					
6					
7					
8					
9					
10					
11					
12					



Client: City of San Diego
 Project: Ocean Beach Pier
 Design For: Deck Evaluation
Midspan - 13 Strands Missing

Job Number 9487
 Sheet 2 of 2
 Designer SJS Date _____
 Checker _____ Date _____

Positive Moment Capacity

NOTES:

- (1) Analysis of a reinforced concrete or prestressed beam per ACI 318-14 using strain compatibility
- (2) Positive stresses and strains are compressive, negative are tensile
- (3) Moments are calculated about the midheight of the cross section
- (4) The longitudinal steel area used for torsion is subtracted from each mild steel with *Type = Main* according to the ratio of $A_{l,torsion}$ to $A_{l,main}$. The area of steel with *Type = Skin* is not reduced for torsion, $A_{s,eff}$ is the effective area per layer including the reduction in steel area due to torsion.

POSITIVE MOMENT CAPACITY

Concrete Response

c	a	A_c	ϵ_c	f_c	C_c	M_c
in	in	in ²	in/in	ksi	kip	kip-in
1.09	0.92	73.9	0.003	4.00	251	1,392

Prestressed / Post-Tensioned Steel Response

Layer	d_p	Type	$A_{p,total}$	f_{pe}	$\epsilon_{p,prestress}$	$\epsilon_{p,axial}$	$\epsilon_{p,flex}$	$\epsilon_{p,total}$	f_{ps}	F_p	M_p
	in		in ²	ksi	in/in	in/in	in/in	in/in	ksi	kip	kip-in
1	10.25	Bonded	0.46	144	-0.0051	-0.00005	-0.0253	-0.0304	-260.0	-119.4	507
2											
3											
4											
5											
6											
7											
8											
9											
10											
11											
12											

Steel Response

Layer	d_s	# bars	Type	$A_{s,total}$	$A_{s,eff}$	$\epsilon_{s,flex}$	$\epsilon_{s,axial}$	$\epsilon_{s,total}$	f_s	F_s	M_s
	in			in ²	in ²	in/in	in/in	in/in	ksi	kip	kip-in
1	2.4	5	Main	2.20	2.20	-0.0036		-0.0036	-60.0	-132.0	-475
2											
3											
4											
5											
6											
7											
8											
9											
10											
11											
12											

Demand

$P_u =$ _____ kip
 $M_u =$ _____ kip-ft
 $\phi =$ 0.90 (ACI 21.2.2)

Reduced Moment Strength

$\Sigma M_{mid} =$ 119 kip-ft
 $\phi M_n =$ 106.8 kip-ft

$\Sigma F_s + \Sigma C_c = 0$ OK!

Flexural Strength Adequate!

Geometry and Material Input

NOTES:

- (1) b_w for hollow sections is the width of *ONE* web
- (2) Mild steel uses a bi-linear hardening model (hardening ratio: $b = E_{sh} / E_s$)
- (3) Prestressed / Post-Tensioned steel uses the Menegotto-Pinto model
- (4) Axial load is applied through the center of gravity of the section (c.g.c), ie no additional moment
- (5) Compressive force, stress, and strain are positive, tensile is negative (except in material definition)

Geometry

h =	12	in
h_{top} =		in
h_{bot} =		in
b_w =	80	in
b_{top} =		in
b_{bot} =		in
Shape:	SOLID	

Concrete Material Properties

f'_c =	4	ksi
β_1 =	0.85	
ϵ_{cu} =	0.003	in/in

Mild Steel Material Properties

E_s =	29,000	ksi
f_y =	60	ksi
b =		

PS / PT Material Properties

E_p =	28,500	ksi
f_{pu} =	270	ksi
σ_o =	253.6	ksi
R =	7.48	
b =	0.0105	

Axial Load on Section

P_a =		kip
---------	--	-----

Total Prestress: 44.1 kip

Long. Steel Required for Torsion

$A_{l,t}$ =		in^2
-------------	--	--------

Cross Section

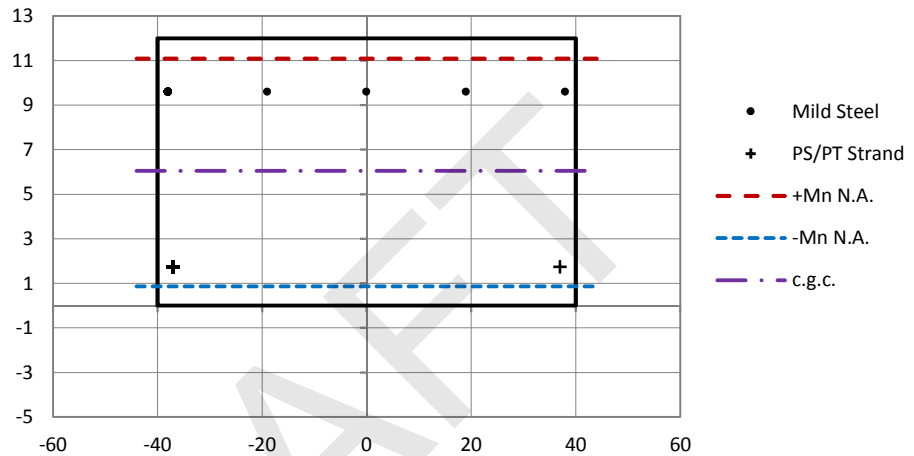

Steel Models

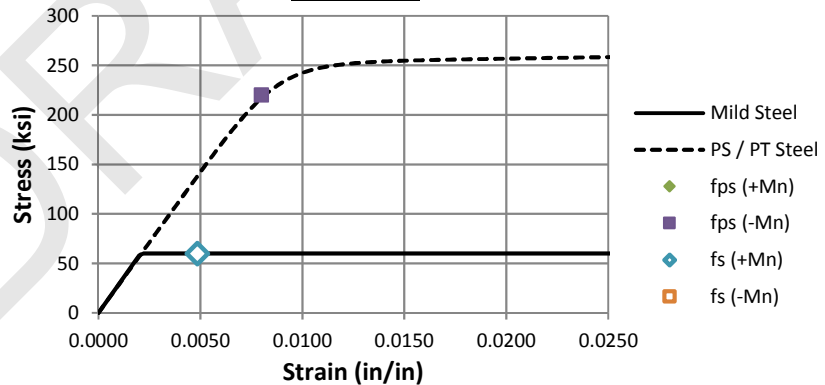

Mild Steel Locations

Layer	# bars	A_{bar} in^2	d_s in	Type
1	5	0.44	2.4	Main
2				
3				
4				
5				
6				
7				
8				
9				
10				
11				
12				

Prestressed / Post Tensioned Steel Locations

Layer	# strands	A_{strand} in^2	d_p in	f_{pe} ksi	Type
1	2	0.153	10.25	144	Bonded
2					
3					
4					
5					
6					
7					
8					
9					
10					
11					
12					



Client: City of San Diego
 Project: Ocean Beach Pier
 Design For: Deck Evaluation
Midspan - 14 Strands Missing

Job Number 9487
 Sheet 2 of 2
 Designer SJS Date _____
 Checker _____ Date _____

Positive Moment Capacity

NOTES:

- (1) Analysis of a reinforced concrete or prestressed beam per ACI 318-14 using strain compatibility
- (2) Positive stresses and strains are compressive, negative are tensile
- (3) Moments are calculated about the midheight of the cross section
- (4) The longitudinal steel area used for torsion is subtracted from each mild steel with *Type = Main* according to the ratio of $A_{l,torsion}$ to $A_{l,main}$. The area of steel with *Type = Skin* is not reduced for torsion, $A_{s,eff}$ is the effective area per layer including the reduction in steel area due to torsion.

POSITIVE MOMENT CAPACITY

Concrete Response

c	a	A_c	ϵ_c	f_c	C_c	M_c
in	in	in ²	in/in	ksi	kip	kip-in
0.92	0.78	62.4	0.003	4.00	212	1,190

Prestressed / Post-Tensioned Steel Response

Layer	d_p	Type	$A_{p,total}$	f_{pe}	$\epsilon_{p,prestress}$	$\epsilon_{p,axial}$	$\epsilon_{p,flex}$	$\epsilon_{p,total}$	f_{ps}	F_p	M_p
	in		in ²	ksi	in/in	in/in	in/in	in/in	ksi	kip	kip-in
1	10.25	Bonded	0.31	144	-0.0051	-0.00003	-0.0305	-0.0356	-261.6	-80.0	340
2											
3											
4											
5											
6											
7											
8											
9											
10											
11											
12											

Steel Response

Layer	d_s	# bars	Type	$A_{s,total}$	$A_{s,eff}$	$\epsilon_{s,flex}$	$\epsilon_{s,axial}$	$\epsilon_{s,total}$	f_s	F_s	M_s
	in			in ²	in ²	in/in	in/in	in/in	ksi	kip	kip-in
1	2.4	5	Main	2.20	2.20	-0.0049		-0.0049	-60.0	-132.0	-475
2											
3											
4											
5											
6											
7											
8											
9											
10											
11											
12											

Demand

$P_u =$ _____ kip
 $M_u =$ _____ kip-ft
 $\phi =$ 0.90 (ACI 21.2.2)

Reduced Moment Strength

$\Sigma M_{mid} =$ 88 kip-ft
 $\phi M_n =$ 79.1 kip-ft

$\Sigma F_s + \Sigma C_c = 0$ OK!

Flexural Strength Adequate!

Geometry and Material Input

NOTES:

- (1) b_w for hollow sections is the width of ONE web
- (2) Mild steel uses a bi-linear hardening model (hardening ratio: $b = E_{sh} / E_s$)
- (3) Prestressed / Post-Tensioned steel uses the Menegotto-Pinto model
- (4) Axial load is applied through the center of gravity of the section (c.g.c), ie no additional moment
- (5) Compressive force, stress, and strain are positive, tensile is negative (except in material definition)

Geometry

h =	12	in
h_{top} =		in
h_{bot} =		in
b_w =	80	in
b_{top} =		in
b_{bot} =		in
Shape:	SOLID	

Concrete Material Properties

f'_c =	4	ksi
β_1 =	0.85	
ϵ_{cu} =	0.003	in/in

Mild Steel Material Properties

E_s =	29,000	ksi
f_y =	60	ksi
b =		

PS / PT Material Properties

E_p =	28,500	ksi
f_{pu} =	270	ksi
σ_o =	253.6	ksi
R =	7.48	
b =	0.0105	

Axial Load on Section

P_a =		kip
---------	--	-----

Total Prestress: **22.0 kip**

Long. Steel Required for Torsion

$A_{l,t}$ =		in^2
-------------	--	--------

Cross Section

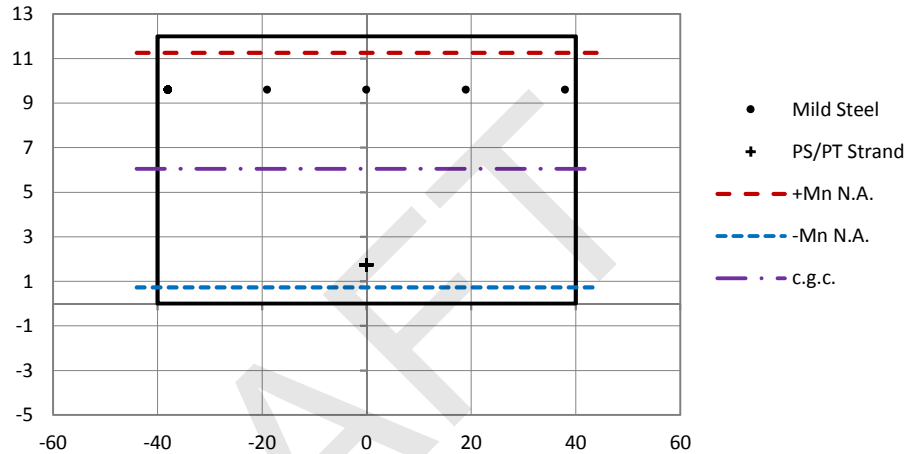

Steel Models

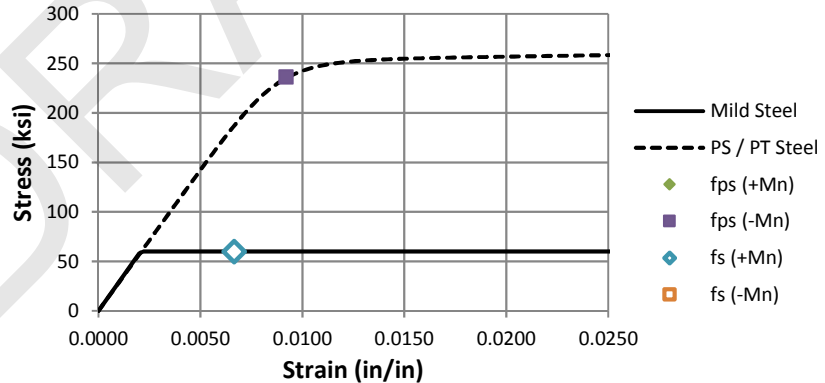

Mild Steel Locations

Layer	# bars	A_{bar} in^2	d_s in	Type
1	5	0.44	2.4	Main
2				
3				
4				
5				
6				
7				
8				
9				
10				
11				
12				

Prestressed / Post Tensioned Steel Locations

Layer	# strands	A_{strand} in^2	d_p in	f_{pe} ksi	Type
1	1	0.153	10.25	144	Bonded
2					
3					
4					
5					
6					
7					
8					
9					
10					
11					
12					



Client: City of San Diego
 Project: Ocean Beach Pier
 Design For: Deck Evaluation
Midspan - 15 Strands Missing

Job Number 9487
 Sheet 2 of 2
 Designer SJS Date _____
 Checker _____ Date _____

Positive Moment Capacity

NOTES:

- (1) Analysis of a reinforced concrete or prestressed beam per ACI 318-14 using strain compatibility
- (2) Positive stresses and strains are compressive, negative are tensile
- (3) Moments are calculated about the midheight of the cross section
- (4) The longitudinal steel area used for torsion is subtracted from each mild steel with *Type = Main* according to the ratio of $A_{l,torsion}$ to $A_{l,main}$. The area of steel with *Type = Skin* is not reduced for torsion, $A_{s,eff}$ is the effective area per layer including the reduction in steel area due to torsion.

POSITIVE MOMENT CAPACITY

Concrete Response

c	a	A_c	ϵ_c	f_c	C_c	M_c
in	in	in ²	in/in	ksi	kip	kip-in
0.75	0.63	50.7	0.003	4.00	172	980

Prestressed / Post-Tensioned Steel Response

Layer	d_p	Type	$A_{p,total}$	f_{pe}	$\epsilon_{p,prestress}$	$\epsilon_{p,axial}$	$\epsilon_{p,flex}$	$\epsilon_{p,total}$	f_{ps}	F_p	M_p
	in		in ²	ksi	in/in	in/in	in/in	in/in	ksi	kip	kip-in
1	10.25	Bonded	0.15	144	-0.0051	-0.00002	-0.0382	-0.0433	-263.9	-40.4	172
2											
3											
4											
5											
6											
7											
8											
9											
10											
11											
12											

Steel Response

Layer	d_s	# bars	Type	$A_{s,total}$	$A_{s,eff}$	$\epsilon_{s,flex}$	$\epsilon_{s,axial}$	$\epsilon_{s,total}$	f_s	F_s	M_s
	in			in ²	in ²	in/in	in/in	in/in	ksi	kip	kip-in
1	2.4	5	Main	2.20	2.20	-0.0067		-0.0067	-60.0	-132.0	-475
2											
3											
4											
5											
6											
7											
8											
9											
10											
11											
12											

Demand

$P_u =$ _____ kip
 $M_u =$ _____ kip-ft
 $\phi =$ 0.90 (ACI 21.2.2)

Reduced Moment Strength

$\Sigma M_{mid} =$ 56 kip-ft
 $\phi M_n =$ 50.7 kip-ft

$\Sigma F_s + \Sigma C_c = 0$ OK!

Flexural Strength Adequate!

Geometry and Material Input

NOTES:

- (1) b_w for hollow sections is the width of *ONE* web
- (2) Mild steel uses a bi-linear hardening model (hardening ratio: $b = E_{sh} / E_s$)
- (3) Prestressed / Post-Tensioned steel uses the Menegotto-Pinto model
- (4) Axial load is applied through the center of gravity of the section (c.g.c), ie no additional moment
- (5) Compressive force, stress, and strain are positive, tensile is negative (except in material definition)

Geometry

h =	12	in
h_{top} =		in
h_{bot} =		in
b_w =	80	in
b_{top} =		in
b_{bot} =		in
Shape:	SOLID	

Concrete Material Properties

f'_c =	4	ksi
β_1 =	0.85	
ϵ_{cu} =	0.003	in/in

Mild Steel Material Properties

E_s =	29,000	ksi
f_y =	60	ksi
b =		

PS / PT Material Properties

E_p =	28,500	ksi
f_{pu} =	270	ksi
σ_o =	253.6	ksi
R =	7.48	
b =	0.0105	

Axial Load on Section

P_a =		kip
---------	--	-----

Total Prestress: _____ **kip**

Long. Steel Required for Torsion

$A_{l,t}$ =		in^2
-------------	--	--------

Cross Section

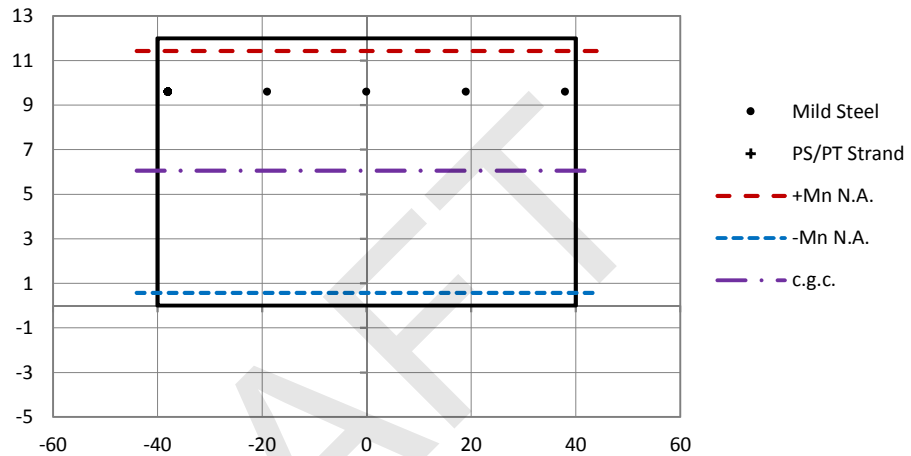

Steel Models

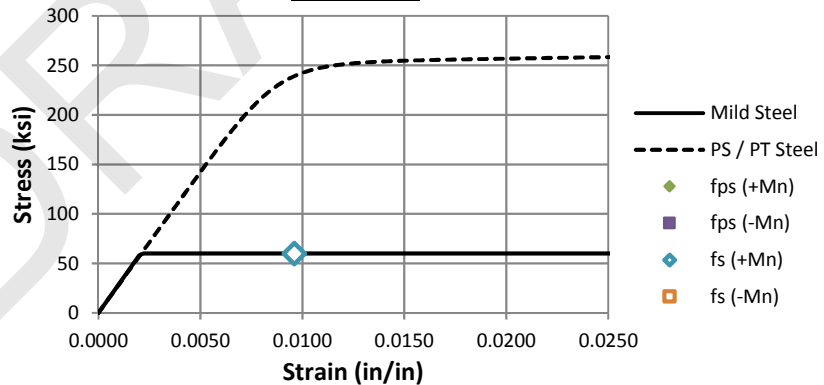

Mild Steel Locations

Layer	# bars	A_{bar} in^2	d_s in	Type
1	5	0.44	2.4	Main
2				
3				
4				
5				
6				
7				
8				
9				
10				
11				
12				

Prestressed / Post Tensioned Steel Locations

Layer	# strands	A_{strand} in^2	d_p in	f_{pe} ksi	Type
1		0.153	10.25	144	Bonded
2					
3					
4					
5					
6					
7					
8					
9					
10					
11					
12					



Client: City of San Diego
 Project: Ocean Beach Pier
 Design For: Deck Evaluation
Midspan - ALL (16) Strands Missing

Job Number 9487
 Sheet 2 of 2
 Designer SJS Date _____
 Checker _____ Date _____

Positive Moment Capacity

NOTES:

- (1) Analysis of a reinforced concrete or prestressed beam per ACI 318-14 using strain compatibility
- (2) Positive stresses and strains are compressive, negative are tensile
- (3) Moments are calculated about the midheight of the cross section
- (4) The longitudinal steel area used for torsion is subtracted from each mild steel with *Type = Main* according to the ratio of $A_{l,torsion}$ to $A_{l,main}$. The area of steel with *Type = Skin* is not reduced for torsion, $A_{s,eff}$ is the effective area per layer including the reduction in steel area due to torsion.

POSITIVE MOMENT CAPACITY

Concrete Response

c	a	A_c	ϵ_c	f_c	C_c	M_c
in	in	in ²	in/in	ksi	kip	kip-in
0.57	0.49	38.8	0.003	4.00	132	760

Prestressed / Post-Tensioned Steel Response

Layer	d_p in	Type	$A_{p,total}$ in ²	f_{pe} ksi	$\epsilon_{p,prestress}$ in/in	$\epsilon_{p,axial}$ in/in	$\epsilon_{p,flex}$ in/in	$\epsilon_{p,total}$ in/in	f_{ps} ksi	F_p kip	M_p kip-in
1	10.25	Bonded		144							
2											
3											
4											
5											
6											
7											
8											
9											
10											
11											
12											

Steel Response

Layer	d_s in	# bars	Type	$A_{s,total}$ in ²	$A_{s,eff}$ in ²	$\epsilon_{s,flex}$ in/in	$\epsilon_{s,axial}$ in/in	$\epsilon_{s,total}$ in/in	f_s ksi	F_s kip	M_s kip-in
1	2.4	5	Main	2.20	2.20	-0.0096		-0.0096	-60.0	-132.0	-475
2											
3											
4											
5											
6											
7											
8											
9											
10											
11											
12											

Demand

$P_u =$ _____ kip
 $M_u =$ _____ kip-ft
 $\phi =$ 0.90 (ACI 21.2.2)

Reduced Moment Strength

$\Sigma M_{mid} =$ 24 kip-ft
 $\phi M_n =$ 21.4 kip-ft

$\Sigma F_s + \Sigma C_c = 0$ OK!

Flexural Strength Adequate!

Appendix C – Pile Detailed Calculations

DRAFT

XTRACT Material Report

Moffatt & Nichol
Moffatt & Nichol
3/14/2018
Ocean Beach Pier
Piles
Page __ of __

Material Name: Rebar60 Nomimnal
Material Type: Strain Hardening Steel

Input Parameters:

Yield Stress: 60.00 ksi
Fracture Stress: 60.00 ksi
Yield Strain: 2.069E-3
Strain at Strain Hardening: 11.50E-3
Failure Strain: .1200
Elastic Modulus: 29.00E+3 ksi
Additional Information: Symetric Tension and Comp.

Model Details:

For Strain - $\varepsilon < \varepsilon_y$ $f_s = E \cdot \varepsilon$

For Strain - $\varepsilon < \varepsilon_{sh}$ $f_s = f_y$

For Strain - $\varepsilon < \varepsilon_{su}$ $f_s = f_u - (f_u - f_y) \cdot \left(\frac{\varepsilon_{su} - \varepsilon}{\varepsilon_{su} - \varepsilon_{sh}} \right)^2$

ε = Steel Strain

f_s = Steel Stress

f_y = Yield Stress

f_u = Fracture Stress

ε_y = Yield Strain

ε_{sh} = Strain at Strain Hardening

ε_{su} = Failure Strain

E = Elastic Modulus

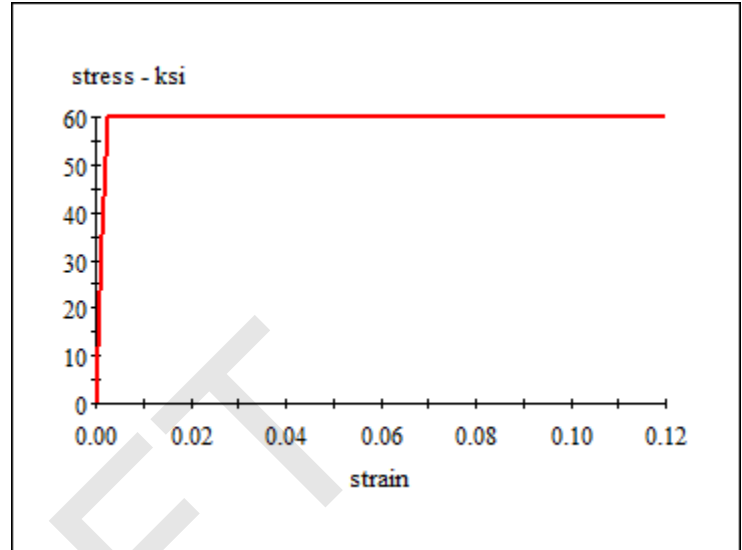

Material Color States:

- Tension force after onset of strain hardening
- Tension force after yield
- Initial state
- Compression force after yield
- Compression force after onset of strain hardening

XTRACT Material Report

Material Name: PreStress1 Nominal

Material Type: Prestressing Steel

Moffatt & Nichol

Moffatt & Nichol

3/14/2018

Ocean Beach Pier

Piles

Page __ of __

Input Parameters:

Yield Stress: 229.5 ksi
Peak Stress: 270.0 ksi
Yield Strain: 7.914E-3
Strain at Peak Stress: 35.00E-3
Failure Strain: 35.00E-3
Elastic Modulus: 29.00E+3 ksi
Additional Information: Symetric Tension and Comp.

Model Details:

$$\text{For Strain - } \varepsilon < \varepsilon_y \quad f_s = E \cdot \varepsilon$$
$$\text{For Strain - } \varepsilon < \varepsilon_{su} \quad f_s = f_u - (f_u - f_y) \cdot \left(\frac{\varepsilon_{sp} - \varepsilon}{\varepsilon_{sp} - \varepsilon_{sh}} \right)^2$$

ε = Steel Strain

f_s = Steel Stress

f_y = Yield Stress

f_u = Fracture Stress

ε_y = Yield Strain

ε_{sp} = Strain at Peak Stress

ε_{su} = Failure Strain

E = Elastic Modulus

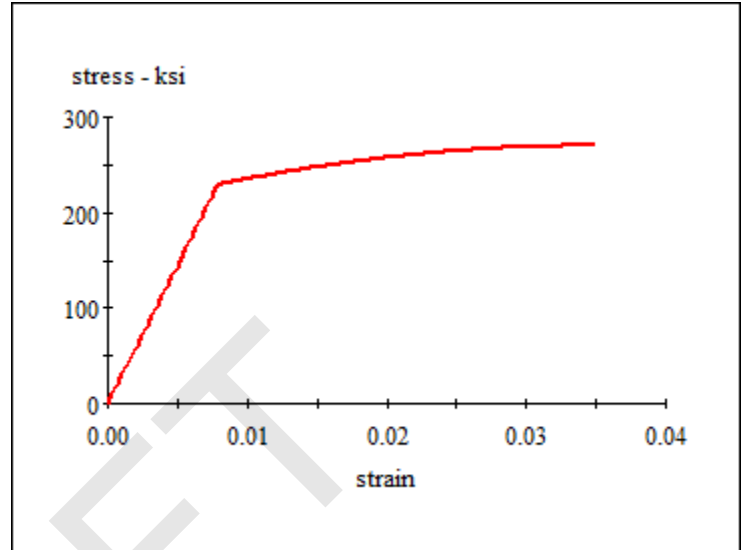

Material Color States:

- Tension force after yield
- Initial state
- Compression force after yield

XTRACT Material Report

Material Name: 5ksi Nominal
 Material Type: Unconfined Concrete

Moffatt & Nichol
 Moffatt & Nichol
 3/14/2018
 Ocean Beach Pier
 Piles
 Page __ of __

Input Parameters:

Tension Strength: 0 ksi
 28 Day Strength: 5.000 ksi
 Post Crushing Strength: 0 ksi
 Tension Strain Capacity: 0 Ten
 Spalling Strain: 5.000E-3 Comp
 Failure Strain: 5.000E-3 Comp
 Elastic Modulus: 4031 ksi
 Secant Modulus: 2500 ksi

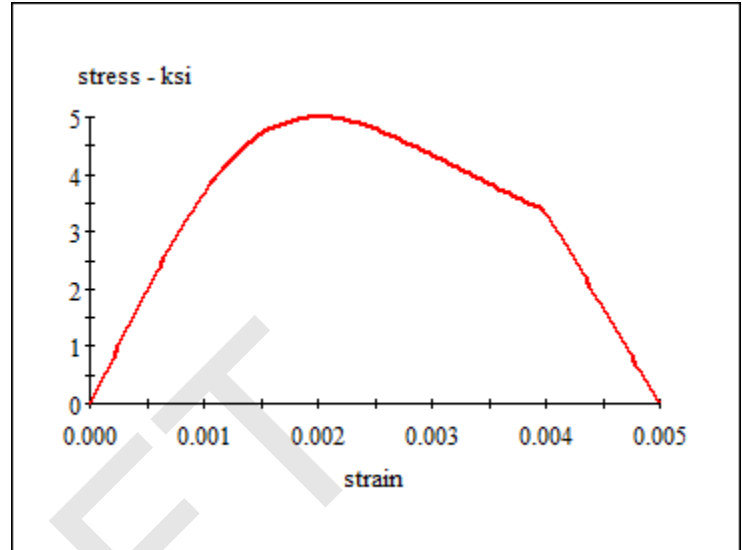

Model Details:

For Strain - $\varepsilon < 2 \cdot \varepsilon_t$ $f_c = 0$
 For Strain - $\varepsilon < 0$ $f_c = \varepsilon \cdot E_c$
 For Strain - $\varepsilon < \varepsilon_{cu}$ $f_c = \frac{f_c \cdot x \cdot r}{r - 1 + x^r}$
 For Strain - $\varepsilon < \varepsilon_{sp}$ $f_c = f_{cu} + (f_{cp} - f_{cu}) \cdot \frac{(\varepsilon - \varepsilon_{cu})}{(\varepsilon_{sp} - \varepsilon_{cu})}$

$$x = \frac{\varepsilon}{\varepsilon_{cc}}$$

$$r = \frac{E_c}{E_c - E_{sec}}$$

$$E_{sec} = \frac{f_c}{\varepsilon_{cc}}$$

ε = Concrete Strain

f_c = Concrete Stress

E_c = Elastic Modulus

E_{sec} = Secant Modulus

ε_t = Tension Strain Capacity

ε_{cu} = Ultimate Concrete Strain

ε_{cc} = Strain at Peak Stress = .002

ε_{sp} = Spalling Strain

f_c = 28 Day Compressive Strength

f_{cu} = Stress at ε_{cu}

f_{cp} = Post Spalling Strength

Material Color States:

- Tension strain after tension capacity
- Tension strain before tension capacity
- Initial state
- Compression before crushing strain
- Compression before end of spalling
- Compression after spalling

Reference:

Mander, J.B., Priestley, M. J. N., "Observed Stress-Strain Behavior of Confined Concrete", Journal of Structural Engineering, ASCE, Vol. 114, No. 8, August 1988, pp. 1827-1849

XTRACT Section Report

Moffatt & Nichol
Moffatt & Nichol
3/14/2018
Ocean Beach Pier
Piles
Page __ of __

Section Name: Original 16-in PS Only

Section Details:

X Centroid: 4.79E-17 in
Y Centroid: -8.24E-17 in
Section Area: 212.1 in²
EI gross about X: 14.97E+6 kip-in²
EI gross about Y: 14.97E+6 kip-in²
I trans (5ksi Nominal) about X: 3714 in⁴
I trans (5ksi Nominal) about Y: 3714 in⁴
Reinforcing Bar Area: 1.530 in²
Percent Longitudinal Steel: .7215 %
Overall Width: 16.00 in
Overall Height: 16.00 in
Number of Fibers: 350
Number of Bars: 10
Number of Materials: 2

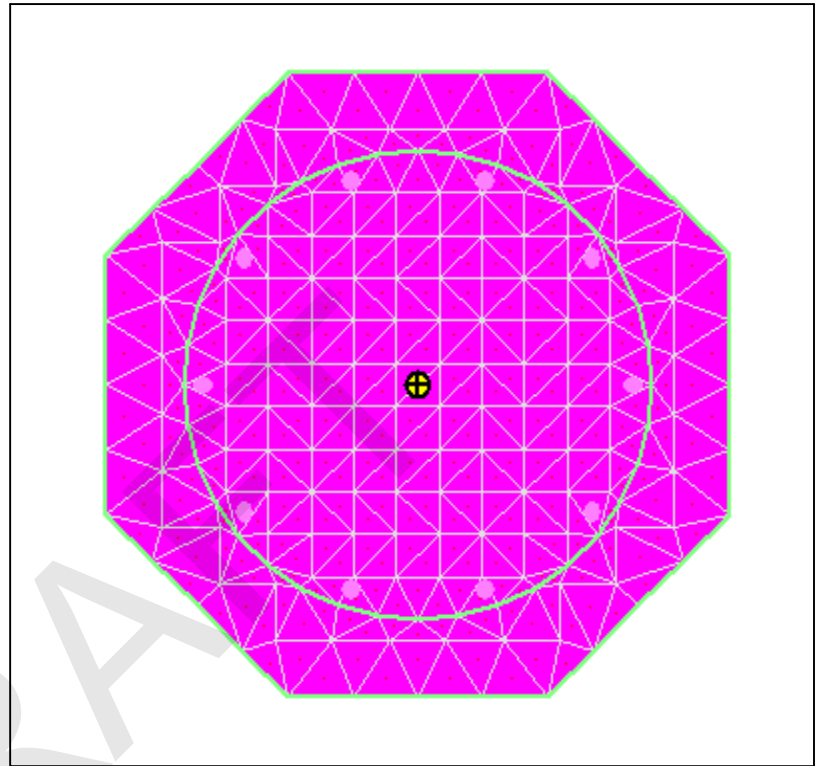

Material Types and Names:

Prestressing Steel: ■ PreStress1 Nominal
Unconfined Concrete: ■ 5ksi Nominal

Comments:

User Comments

XTRACT Section Report

Section Name: Original 16-in PS Only

Moffatt & Nichol
Moffatt & Nichol
3/14/2018
Ocean Beach Pier
Piles
Page __ of __

Reinforcing Bar List:

Bar Number	X (in)	Y (in)	Bar Size	Area (in ²)	Prestress (kips)	Material Type
1	5.500	0	-	.1530	22.80	PreStress1 Nominal
2	4.450	3.230	-	.1530	22.80	PreStress1 Nominal
3	1.700	5.230	-	.1530	22.80	PreStress1 Nominal
4	-1.700	5.230	-	.1530	22.80	PreStress1 Nominal
5	-4.450	3.230	-	.1530	22.80	PreStress1 Nominal
6	-5.500	0	-	.1530	22.80	PreStress1 Nominal
7	-4.450	-3.230	-	.1530	22.80	PreStress1 Nominal
8	-1.700	-5.230	-	.1530	22.80	PreStress1 Nominal
9	1.700	-5.230	-	.1530	22.80	PreStress1 Nominal
10	4.450	-3.230	-	.1530	22.80	PreStress1 Nominal

DRAFT

XTRACT Analysis Report

Moffatt & Nichol
 Moffatt & Nichol
 3/14/2018
 Ocean Beach Pier
 Piles
 Page __ of __

Section Name: Original 16-in PS Only
 Loading Name: PM
 Analysis Type: PM Interaction

Section Details:

X Centroid: 4.79E-17 in
 Y Centroid: -8.24E-17 in
 Section Area: 212.1 in^2

Loading Details:

Angle of Loading: 0 deg
 Number of Points: 80
 Min. PreStress1 Nominal Stra 35.00E-3 Comp
 Max. PreStress1 Nominal Stra 35.00E-3 Ten
 Min. 5ksi Nominal Strain: 3.000E-3 Comp
 Max. 5ksi Nominal Strain: 1.0000 Ten

Analysis Results:

Max. Compression Load: 869.1 kips
 Max. Tension Load: -413.1 kips
 Maximum Moment: 1903 kip-in
 P at Max. Moment: 267.2 kips
 Minimum Moment: -1903 kip-in
 P at Min. Moment: 267.2 kips
 Moment (Mxx) at P=0: 1664 kip-in
 Max. Code Comp. Load: 0 kips
 Max. Code Ten. Load: 0 kips
 Maximum Code Moment: 0 kip-in
 P at Max. Code Moment: 0 kips
 Minimum Code Moment: 0 kip-in
 P at Min. Code Moment: 0 kips
 PM Interaction Equation: Units in kip-in

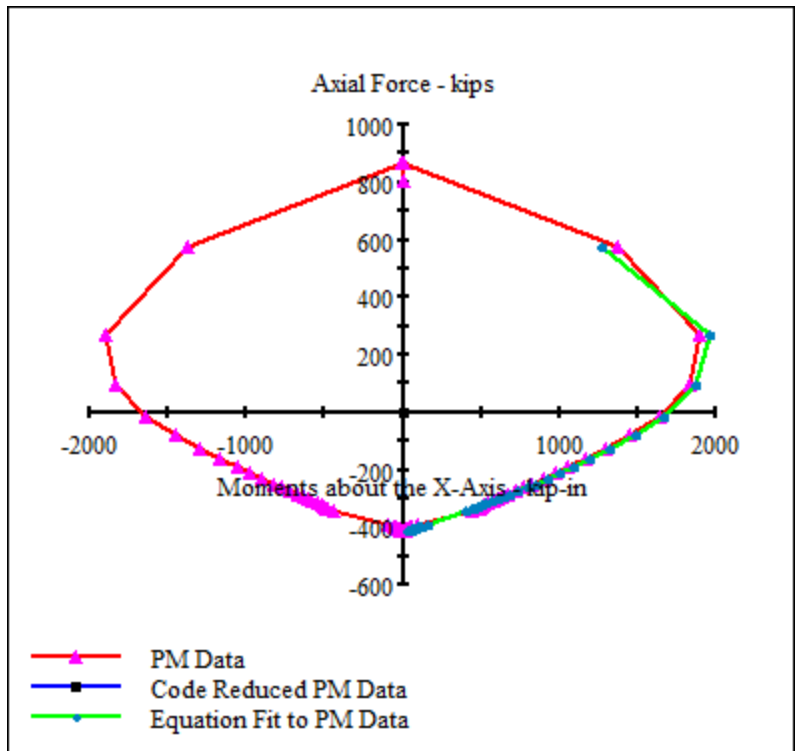
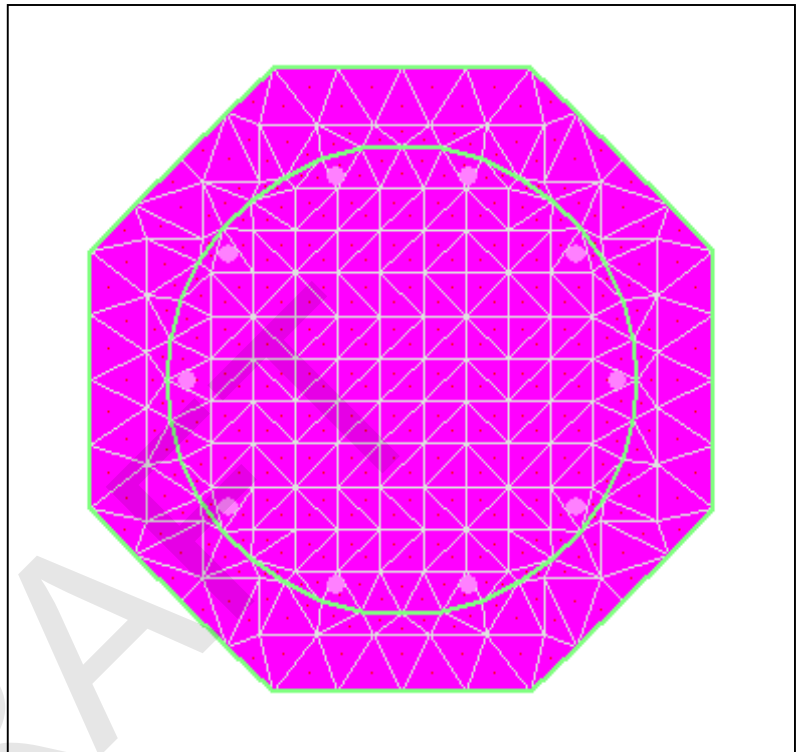

XTRACT Section Report

Moffatt & Nichol
Moffatt & Nichol
3/14/2018
Ocean Beach Pier
Piles
Page __ of __

Section Name: Original 16-in Mild Only

Section Details:

X Centroid: 4.50E-17 in
Y Centroid: -5.98E-17 in
Section Area: 212.1 in²
EI gross about X: 14.97E+6 kip-in²
EI gross about Y: 14.97E+6 kip-in²
I trans (5ksi Nominal) about X: 3982 in⁴
I trans (5ksi Nominal) about Y: 3982 in⁴
Reinforcing Bar Area: 5.068 in²
Percent Longitudinal Steel: 2.390 %
Overall Width: 16.00 in
Overall Height: 16.00 in
Number of Fibers: 350
Number of Bars: 4
Number of Materials: 2

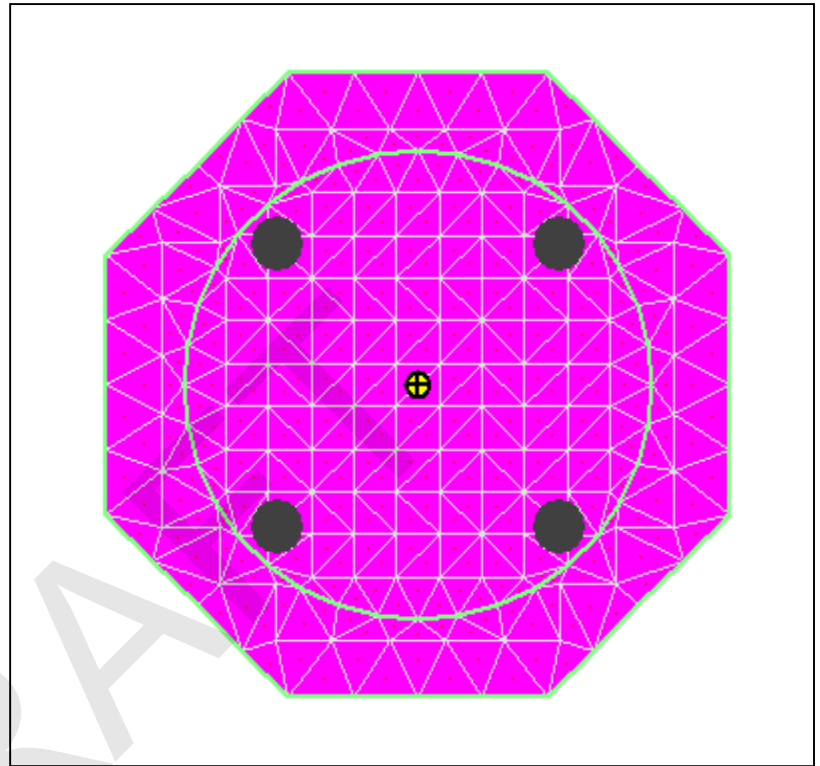

Material Types and Names:

Strain Hardening Steel: ■ Rebar60 Nomimnal
Unconfined Concrete: ■ 5ksi Nominal

Comments:

User Comments

XTRACT Section Report

Section Name: Original 16-in Mild Only

Moffatt & Nichol
Moffatt & Nichol
3/14/2018
Ocean Beach Pier
Piles
Page __ of __

Reinforcing Bar List:

Bar Number	X (in)	Y (in)	Bar Size	Area (in ²)	Prestress (kips)	Material Type
1	3.620	3.620	#10	1.267	0	Rebar60 Nomimnal
2	-3.620	3.620	#10	1.267	0	Rebar60 Nomimnal
3	-3.620	-3.620	#10	1.267	0	Rebar60 Nomimnal
4	3.620	-3.620	#10	1.267	0	Rebar60 Nomimnal

DRAFT

XTRACT Analysis Report

Moffatt & Nichol
Moffatt & Nichol
3/14/2018
Ocean Beach Pier
Piles
Page __ of __

Section Name: Original 16-in Mild Only
Loading Name: PM
Analysis Type: PM Interaction

Section Details:

X Centroid: 4.50E-17 in
Y Centroid: -5.98E-17 in
Section Area: 212.1 in^2

Loading Details:

Angle of Loading: 0 deg
Number of Points: 60
Min. Rebar60 Nomimnal Strain 11.50E-3 Comp
Max. Rebar60 Nomimnal Strain 11.50E-3 Ten
Min. 5ksi Nominal Strain: 3.000E-3 Comp
Max. 5ksi Nominal Strain: 1.0000 Ten

Analysis Results:

Max. Compression Load: 1287 kips
Max. Tension Load: -304.1 kips
Maximum Moment: 2356 kip-in
P at Max. Moment: 263.8 kips
Minimum Moment: -2356 kip-in
P at Min. Moment: 263.8 kips
Moment (Mxx) at P=0: 1490 kip-in
Max. Code Comp. Load: 0 kips
Max. Code Ten. Load: 0 kips
Maximum Code Moment: 0 kip-in
P at Max. Code Moment: 0 kips
Minimum Code Moment: 0 kip-in
P at Min. Code Moment: 0 kips
PM Interaction Equation: Units in kip-in

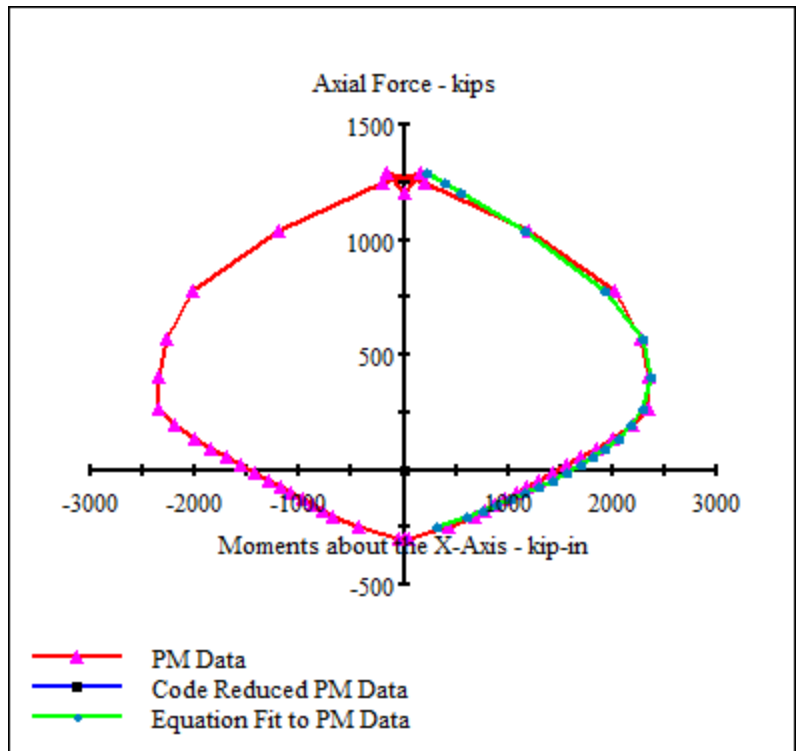
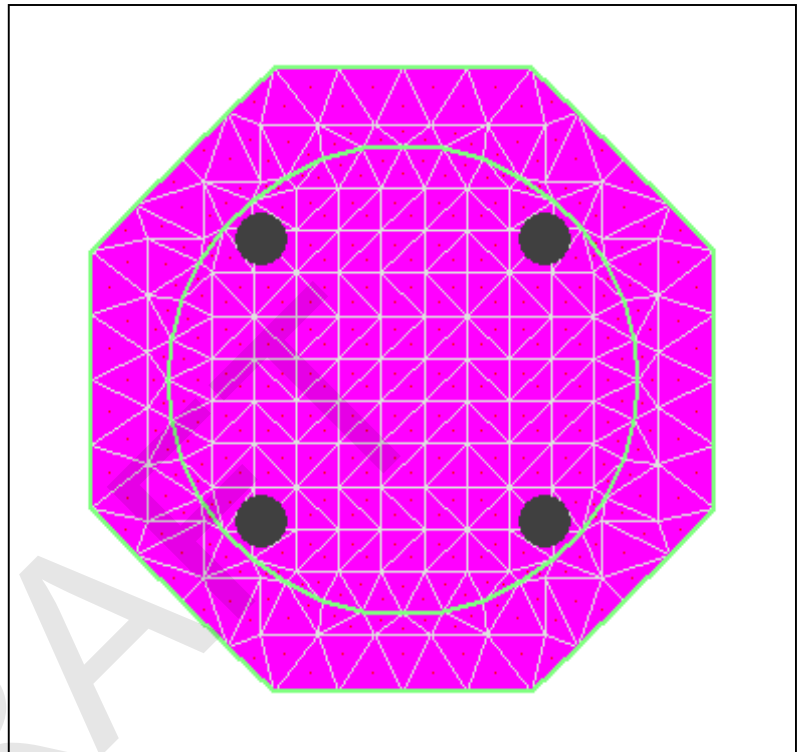

XTRACT Section Report

Moffatt & Nichol
Moffatt & Nichol
3/14/2018
Ocean Beach Pier
Piles
Page __ of __

Section Name: Original 16-in PS and Mild

Section Details:

X Centroid: 4.33E-17 in
Y Centroid: -5.75E-17 in
Section Area: 212.1 in²
EI gross about X: 14.97E+6 kip-in²
EI gross about Y: 14.97E+6 kip-in²
I trans (5ksi Nominal) about X: 4125 in⁴
I trans (5ksi Nominal) about Y: 4125 in⁴
Reinforcing Bar Area: 6.598 in²
Percent Longitudinal Steel: 3.111 %
Overall Width: 16.00 in
Overall Height: 16.00 in
Number of Fibers: 350
Number of Bars: 14
Number of Materials: 3

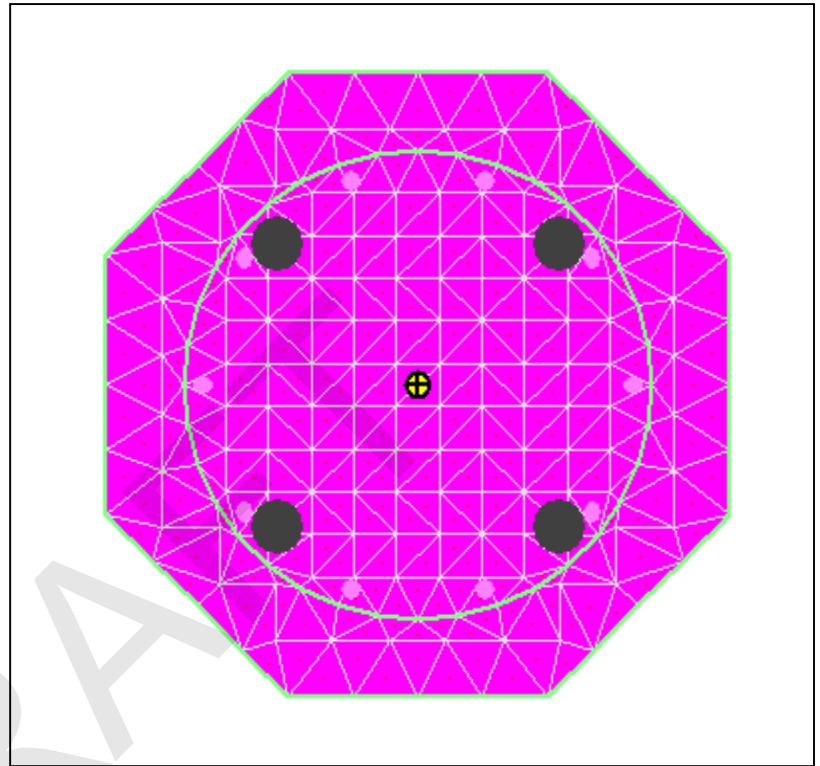

Material Types and Names:

Strain Hardening Steel: ■ Rebar60 Nomimnal
Prestressing Steel: ■ PreStress1 Nominal
Unconfined Concrete: ■ 5ksi Nominal

Comments:

User Comments

XTRACT Section Report

Section Name: Original 16-in PS and Mild

Moffatt & Nichol
Moffatt & Nichol
3/14/2018
Ocean Beach Pier
Piles
Page __ of __

Reinforcing Bar List:

Bar Number	X (in)	Y (in)	Bar Size	Area (in ²)	Prestress (kips)	Material Type
1	5.500	0	-	.1530	22.80	PreStress1 Nominal
2	4.450	3.230	-	.1530	22.80	PreStress1 Nominal
3	1.700	5.230	-	.1530	22.80	PreStress1 Nominal
4	-1.700	5.230	-	.1530	22.80	PreStress1 Nominal
5	-4.450	3.230	-	.1530	22.80	PreStress1 Nominal
6	-5.500	0	-	.1530	22.80	PreStress1 Nominal
7	-4.450	-3.230	-	.1530	22.80	PreStress1 Nominal
8	-1.700	-5.230	-	.1530	22.80	PreStress1 Nominal
9	1.700	-5.230	-	.1530	22.80	PreStress1 Nominal
10	4.450	-3.230	-	.1530	22.80	PreStress1 Nominal
11	3.620	3.620	#10	1.267	0	Rebar60 Nomimnal
12	-3.620	3.620	#10	1.267	0	Rebar60 Nomimnal
13	-3.620	-3.620	#10	1.267	0	Rebar60 Nomimnal
14	3.620	-3.620	#10	1.267	0	Rebar60 Nomimnal

XTRACT Analysis Report

Moffatt & Nichol
 Moffatt & Nichol
 3/14/2018
 Ocean Beach Pier
 Piles
 Page __ of __

Section Name: Original 16-in PS and Mild
 Loading Name: PM
 Analysis Type: PM Interaction

Section Details:

X Centroid: 4.33E-17 in
 Y Centroid: -5.75E-17 in
 Section Area: 212.1 in²

Loading Details:

Angle of Loading: 0 deg
 Number of Points: 60
 Min. Rebar60 Nomimnal Strain 11.50E-3 Comp
 Max. Rebar60 Nomimnal Strain 11.50E-3 Ten
 Min. PreStress1 Nominal Stra 35.00E-3 Comp
 Max. PreStress1 Nominal Stra 35.00E-3 Ten
 Min. 5ksi Nominal Strain: 3.000E-3 Comp
 Max. 5ksi Nominal Strain: 1.0000 Ten

Analysis Results:

Max. Compression Load: 1153 kips
 Max. Tension Load: -689.4 kips
 Maximum Moment: 2638 kip-in
 P at Max. Moment: 7.254 kips
 Minimum Moment: -2638 kip-in
 P at Min. Moment: 7.254 kips
 Moment (Mxx) at P=0: 2624 kip-in
 Max. Code Comp. Load: 0 kips
 Max. Code Ten. Load: 0 kips
 Maximum Code Moment: 0 kip-in
 P at Max. Code Moment: 0 kips
 Minimum Code Moment: 0 kip-in
 P at Min. Code Moment: 0 kips
 PM Interaction Equation: Units in kip-in

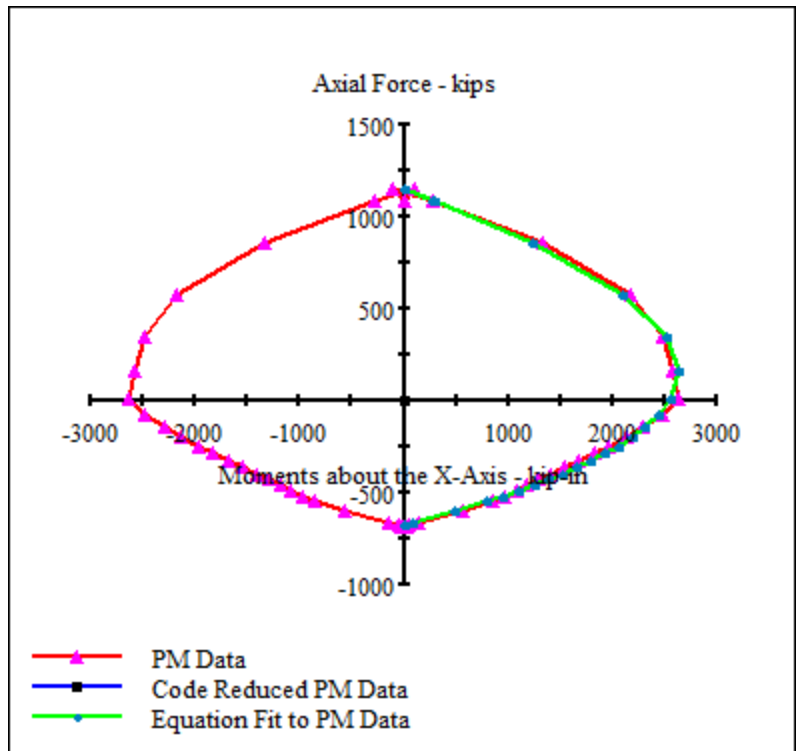
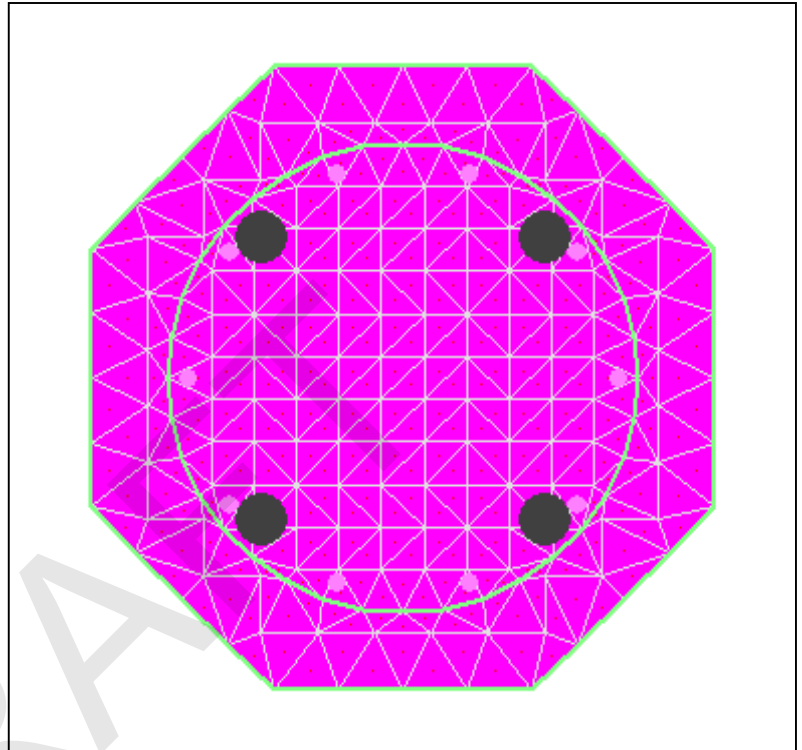

XTRACT Section Report

Moffatt & Nichol
Moffatt & Nichol
3/14/2018
Ocean Beach Pier
Piles
Page __ of __

Section Name: Repaired 16-in

Section Details:

X Centroid: 6.28E-16 in
Y Centroid: 5.46E-17 in
Section Area: 612.0 in²
EI gross about X: 14.97E+6 kip-in²
EI gross about Y: 14.97E+6 kip-in²
I trans (5ksi Nominal) about X: 32.78E+3 in⁴
I trans (5ksi Nominal) about Y: 32.78E+3 in⁴
Reinforcing Bar Area: 5.302 in²
Percent Longitudinal Steel: .8662 %
Overall Width: 25.00 in
Overall Height: 25.00 in
Number of Fibers: 1392
Number of Bars: 12
Number of Materials: 2

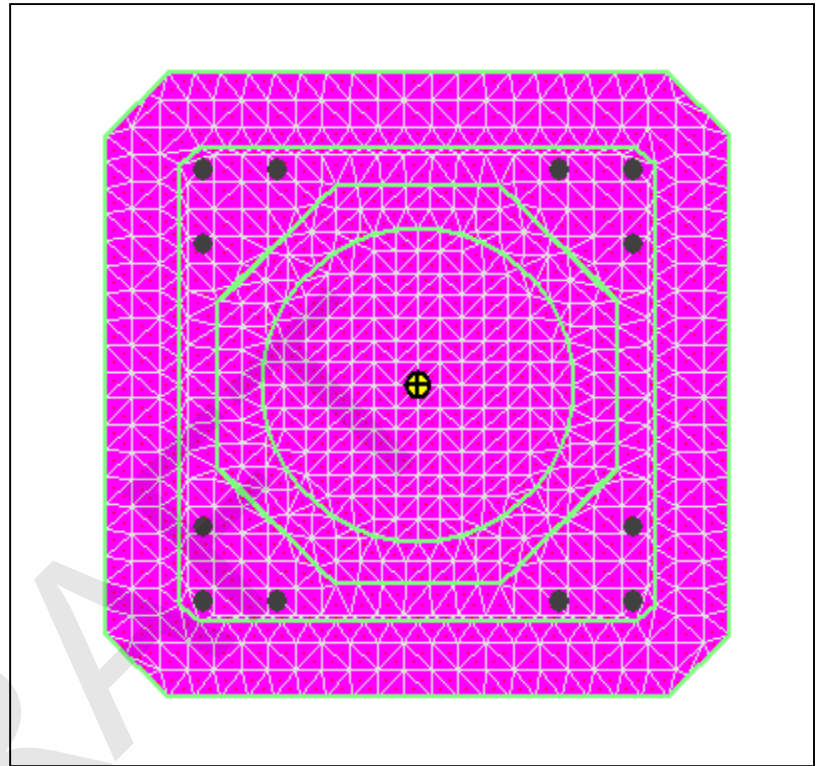

Material Types and Names:

Strain Hardening Steel: ■ Rebar60 Nomimnal
Unconfined Concrete: ■ 5ksi Nominal

Comments:

User Comments

XTRACT Section Report

Section Name: Repaired 16-in

Moffatt & Nichol
Moffatt & Nichol
3/14/2018
Ocean Beach Pier
Piles
Page __ of __

Reinforcing Bar List:

Bar Number	X (in)	Y (in)	Bar Size	Area (in ²)	Prestress (kips)	Material Type
1	-8.630	8.630	#6	.4418	0	Rebar60 Nomimnal
2	-5.630	8.630	#6	.4418	0	Rebar60 Nomimnal
3	-8.630	5.630	#6	.4418	0	Rebar60 Nomimnal
4	8.630	8.630	#6	.4418	0	Rebar60 Nomimnal
5	8.630	5.630	#6	.4418	0	Rebar60 Nomimnal
6	5.630	8.630	#6	.4418	0	Rebar60 Nomimnal
7	-8.630	-8.630	#6	.4418	0	Rebar60 Nomimnal
8	-8.630	-5.630	#6	.4418	0	Rebar60 Nomimnal
9	-5.630	-8.630	#6	.4418	0	Rebar60 Nomimnal
10	8.630	-8.630	#6	.4418	0	Rebar60 Nomimnal
11	8.630	-5.630	#6	.4418	0	Rebar60 Nomimnal
12	5.630	-8.630	#6	.4418	0	Rebar60 Nomimnal

XTRACT Analysis Report

Moffatt & Nichol
Moffatt & Nichol
3/14/2018
Ocean Beach Pier
Piles
Page __ of __

Section Name: Repaired 16-in
Loading Name: PM
Analysis Type: PM Interaction

Section Details:

X Centroid: 6.28E-16 in
Y Centroid: 5.46E-17 in
Section Area: 612.0 in^2

Loading Details:

Angle of Loading: 0 deg
Number of Points: 60
Min. Rebar60 Nomimnal Strain 11.50E-3 Comp
Max. Rebar60 Nomimnal Strain 11.50E-3 Ten
Min. 5ksi Nominal Strain: 3.000E-3 Comp
Max. 5ksi Nominal Strain: 1.0000 Ten

Analysis Results:

Max. Compression Load: 3197 kips
Max. Tension Load: -318.1 kips
Maximum Moment: 10.52E+3 kip-in
P at Max. Moment: 1187 kips
Minimum Moment: -10.52E+3 kip-in
P at Min. Moment: 1187 kips
Moment (Mxx) at P=0: 3315 kip-in
Max. Code Comp. Load: 0 kips
Max. Code Ten. Load: 0 kips
Maximum Code Moment: 0 kip-in
P at Max. Code Moment: 0 kips
Minimum Code Moment: 0 kip-in
P at Min. Code Moment: 0 kips
PM Interaction Equation: Units in kip-in

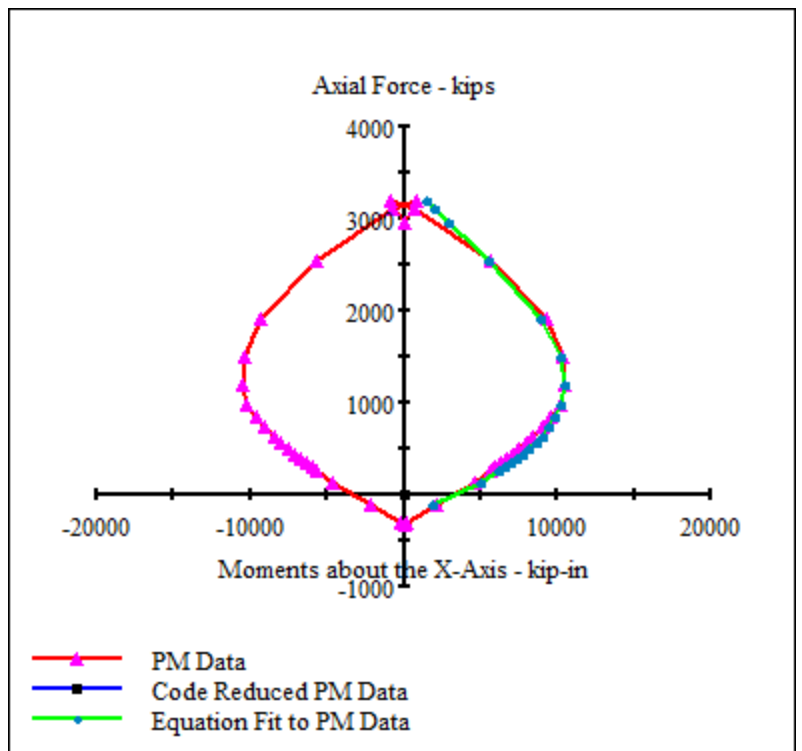
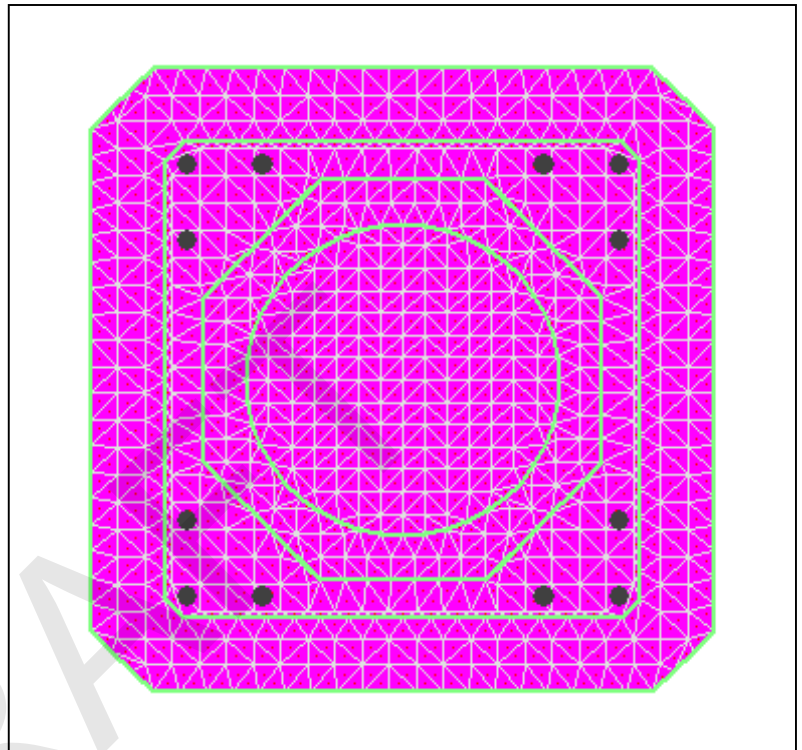



Methodology:

These calculations follow the provisions of ACI 318–14 for the shear design of prestressed concrete members

$$V_u = 0 \text{ kip}$$

$$M_u = 1 \text{ kip} \cdot \text{ft}$$

Since the demands are unknown, use V_u and M_u to arbitrarily set the shear capacity to a minimum, so that $V_u \cdot d / M_u = 0$

Shear demand at the section in interest

Simultaneous flexural demand at the section in interest

Material Properties:

$$f'_c = 5 \text{ ksi}$$

$$f_y = 60 \text{ ksi}$$

$$\phi = 0.75$$

$$\lambda = 1.0$$

Compressive strength of concrete

Yield strength of shear reinforcement

Strength reduction factor for shear per Table 21.2.1(b)

Lightweight concrete modification factor per Table 19.2.4.2

Section Properties:

$$D = 16 \text{ in}$$

$$b_w = D = 16 \cdot \text{in}$$

$$d_p = 0.8 \cdot D = 12.8 \cdot \text{in}$$

Diameter of the circular member

Width of the web of the section, taken as D for circular members.

Depth of the concrete section from the compressive face to the centroid of the tensile steel Taken as 0.8D per 22.5.2.2

Shear Reinforcement:

$$A_v = 2 \cdot (0.05 \text{ in}^2) = 0.1 \cdot \text{in}^2$$

$$s = 3 \text{ in}$$

Area of shear reinforcement (include all legs of the stirrups)

Spacing of the shear reinforcement

Shear Strength:

$$\frac{V_u \cdot d_p}{M_u} = 0$$

$$V_c = \begin{cases} (0.6 \cdot \lambda \cdot \sqrt{f'_c \cdot \text{psi} + 700 \text{ psi}}) \cdot b_w \cdot d_p & \text{if } \frac{V_u \cdot d_p}{M_u} > 1.0 \\ \left(0.6 \cdot \lambda \cdot \sqrt{f'_c \cdot \text{psi} + 700 \text{ psi}} \cdot \frac{V_u \cdot d_p}{M_u} \right) \cdot b_w \cdot d_p & \text{otherwise} \end{cases}$$

Nominal shear strength provided by the concrete per Table 22.5.8.2. Assumes that the effective prestress, f_{pe} , is greater than $0.4f_{pu}$

$$V_c = 8.7 \cdot \text{kip}$$

$$V_{c,\text{min}} = 2 \cdot \lambda \cdot \sqrt{f'_c \cdot \text{psi}} \cdot b_w \cdot d_p = 29 \cdot \text{kip}$$

$$V_{c,\text{max}} = 5 \cdot \lambda \cdot \sqrt{f'_c \cdot \text{psi}} \cdot b_w \cdot d_p = 72.4 \cdot \text{kip}$$

$$V_c = \begin{cases} V_c & \text{if } V_{c,\text{min}} < V_c < V_{c,\text{max}} = 29 \cdot \text{kip} \\ V_{c,\text{min}} & \text{if } V_c < V_{c,\text{min}} \\ V_{c,\text{max}} & \text{if } V_c > V_{c,\text{max}} \end{cases}$$



$$V_{s1} = \frac{A_v \cdot f_y \cdot d_p}{s} = 25.6 \cdot \text{kip}$$

Nominal shear strength provided by the steel reinforcement per 22.5.10.5.3

$$V_{s,\max} = 8 \cdot \sqrt{f'_c \cdot \text{psi}} \cdot b_w \cdot d_p = 115.9 \cdot \text{kip}$$

Maximum shear reinforcement contribution to the nominal shear strength per 22.5.1.2

$$V_s = \min(V_{s1}, V_{s,\max}) = 25.6 \cdot \text{kip}$$

Nominal shear strength provided by the steel with upper limit

$$\phi V_n = \phi \cdot (V_c + V_s) = 41 \cdot \text{kip}$$

Reduced shear strength of the section per 22.5.1.1.1

Check Shear Reinforcement Spacing:

$$V_{s,\text{limit}} = 4 \cdot \sqrt{f'_c \cdot \text{psi}} \cdot b_w \cdot d_p = 57.9 \cdot \text{kip}$$

Limiting shear reinforcement strength for reduced stirrup spacing per 9.7.6.2.2

$$s_{\max} = \begin{cases} \frac{d_p}{2} & \text{if } V_s \leq V_{s,\text{limit}} \\ \frac{d_p}{4} & \text{otherwise} \end{cases} = 6.4 \cdot \text{in}$$

Maximum shear reinforcement spacing per 9.7.6.2.2

$$\text{CHECK} = \begin{cases} \text{"OK!"} & \text{if } s \leq s_{\max} \\ \text{"NG!"} & \text{otherwise} \end{cases} = \text{"OK!"}$$

Check Minimum Shear Reinforcement:

$$A_{v,\min} = \max\left(0.75 \cdot \sqrt{f'_c \cdot \text{psi}} \cdot \frac{b_w \cdot s}{f_y}, 50 \text{psi} \cdot \frac{b_w \cdot s}{f_y}\right) = 0.04 \cdot \text{in}^2$$

Minimum shear reinforcement required per 9.6.3.3

$$\text{CHECK} = \begin{cases} \text{"OK!"} & \text{if } A_v \geq A_{v,\min} \\ \text{"NG!"} & \text{otherwise} \end{cases} = \text{"OK!"}$$

**Methodology:**

These calculations follow the provisions of ACI 318–14 for the shear design of reinforced concrete members ignoring any effects of axial load or prestress on the member.

Material Properties:

$f'_c = 5\text{ksi}$	Compressive strength of concrete
$f_y = 60\text{ksi}$	Yield strength of shear reinforcement
$\phi = 0.75$	Strength reduction factor for shear per Table 21.2.1
$\lambda = 1.0$	Lightweight concrete modification factor per Table 19.2.4.2

Section Properties:

$b_w = 25\text{in}$	Width of the web of the section
$d = 25\text{in}$	Depth of the concrete section from the compressive face to the centroid of the tensile steel

Shear Reinforcement:

$A_v = 2(0.2\text{in}^2) = 0.4 \cdot \text{in}^2$	Area of shear reinforcement (include all legs of the stirrups)
$s = 3\text{in}$	Spacing of the shear reinforcement

Shear Strength:

$V_c = 2 \cdot \lambda \cdot \sqrt{f'_c \cdot \text{psi}} \cdot b_w \cdot d = 88.4 \cdot \text{kip}$	Nominal shear strength provided by the concrete per 22.5.5.1
$V_{s1} = \frac{A_v \cdot f_y \cdot d}{s} = 200 \cdot \text{kip}$	Nominal shear strength provided by the steel reinforcement per 22.5.10.5.3
$V_{s,\text{max}} = 8 \cdot \sqrt{f'_c \cdot \text{psi}} \cdot b_w \cdot d = 353.6 \cdot \text{kip}$	Maximum shear reinforcement contribution to the nominal shear strength per 22.5.1.2
$V_s = \min(V_{s1}, V_{s,\text{max}}) = 200 \cdot \text{kip}$	Nominal shear strength provided by the steel with upper limit
$\phi V_n = \phi \cdot (V_c + V_s) = 216 \cdot \text{kip}$	Reduced shear strength of the section per 22.5.1.1

Check Shear Reinforcement Spacing:

$V_{s,\text{limit}} = 4 \cdot \sqrt{f'_c \cdot \text{psi}} \cdot b_w \cdot d = 176.8 \cdot \text{kip}$	Limiting shear reinforcement strength for reduced stirrup spacing per Table 9.7.6.2.2
$s_{\text{max}} = \begin{cases} \min\left(\frac{d}{2}, 24\text{in}\right) & \text{if } V_s \leq V_{s,\text{limit}} \\ \min\left(\frac{d}{4}, 24\text{in}\right) & \text{otherwise} \end{cases} = 6.25 \cdot \text{in}$	Maximum shear reinforcement spacing per Table 9.7.6.2.2
CHECK = $\begin{cases} \text{"OK!"} & \text{if } s \leq s_{\text{max}} \\ \text{"NG!"} & \text{otherwise} \end{cases} = \text{"OK!"}$	



16" Repaired

Check Minimum Shear Reinforcement:

$$A_{v.min} = \max \left(0.75 \cdot \sqrt{f'_c} \cdot \text{psi} \cdot \frac{b_w \cdot s}{f_y}, 50 \text{psi} \cdot \frac{b_w \cdot s}{f_y} \right) = 0.07 \cdot \text{in}^2$$

Minimum shear
reinforcement required per
9.6.3.3

CHECK = | "OK!" if $A_v \geq A_{v.min}$ = "OK!"
 | "NG!" otherwise

DRAFT

XTRACT Section Report

Moffatt & Nichol
Moffatt & Nichol
3/14/2018
Ocean Beach Pier
Piles
Page __ of __

Section Name: Original 20-in PS Only

Section Details:

X Centroid: -1.93E-16 in
Y Centroid: -2.12E-16 in
Section Area: 331.3 in²
EI gross about X: 14.97E+6 kip-in²
EI gross about Y: 14.97E+6 kip-in²
I trans (5ksi Nominal) about X: 9100 in⁴
I trans (5ksi Nominal) about Y: 9099 in⁴
Reinforcing Bar Area: 2.448 in²
Percent Longitudinal Steel: .7389 %
Overall Width: 20.00 in
Overall Height: 20.00 in
Number of Fibers: 522
Number of Bars: 16
Number of Materials: 2

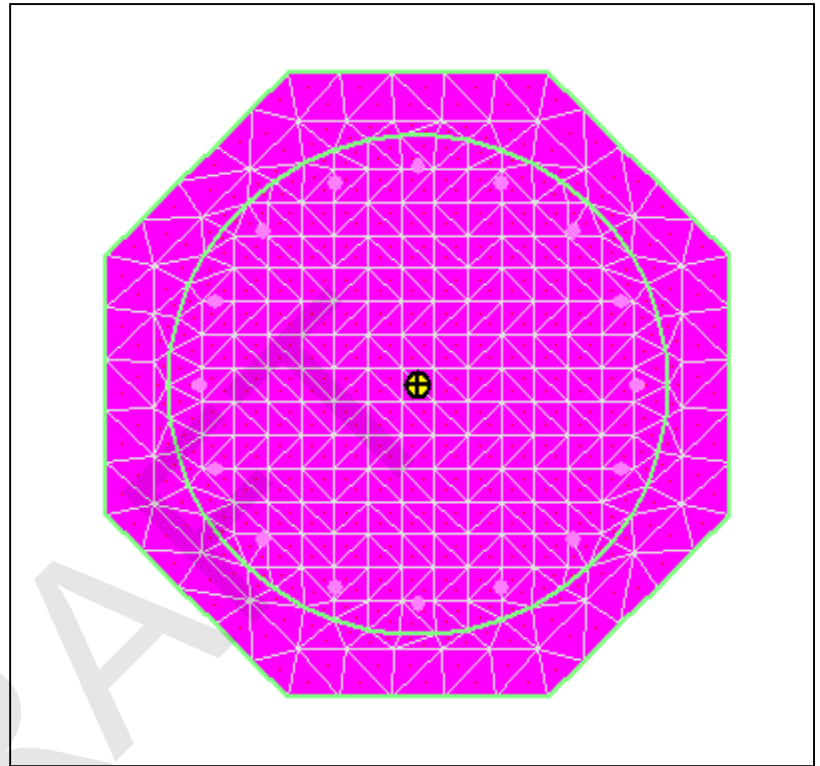

Material Types and Names:

Prestressing Steel: ■ PreStress1 Nominal
Unconfined Concrete: ■ 5ksi Nominal

Comments:

User Comments

XTRACT Section Report

Section Name: Original 20-in PS Only

Moffatt & Nichol
Moffatt & Nichol
3/14/2018
Ocean Beach Pier
Piles
Page __ of __

Reinforcing Bar List:

Bar Number	X (in)	Y (in)	Bar Size	Area (in ²)	Prestress (kips)	Material Type
1	7.000	0	-	.1530	22.80	PreStress1 Nominal
2	6.470	2.680	-	.1530	22.80	PreStress1 Nominal
3	4.950	4.950	-	.1530	22.80	PreStress1 Nominal
4	2.680	6.470	-	.1530	22.80	PreStress1 Nominal
5	0	7.000	-	.1530	22.80	PreStress1 Nominal
6	-2.680	6.470	-	.1530	22.80	PreStress1 Nominal
7	-4.950	4.950	-	.1530	22.80	PreStress1 Nominal
8	-6.470	2.680	-	.1530	22.80	PreStress1 Nominal
9	-7.000	0	-	.1530	22.80	PreStress1 Nominal
10	-6.470	-2.680	-	.1530	22.80	PreStress1 Nominal
11	-4.950	-4.950	-	.1530	22.80	PreStress1 Nominal
12	-2.680	-6.470	-	.1530	22.80	PreStress1 Nominal
13	0	-7.000	-	.1530	22.80	PreStress1 Nominal
14	2.680	-6.470	-	.1530	22.80	PreStress1 Nominal
15	4.950	-4.950	-	.1530	22.80	PreStress1 Nominal
16	6.470	-2.680	-	.1530	22.80	PreStress1 Nominal

XTRACT Analysis Report

Moffatt & Nichol
 Moffatt & Nichol
 3/14/2018
 Ocean Beach Pier
 Piles
 Page __ of __

Section Name: Original 20-in PS Only
 Loading Name: PM
 Analysis Type: PM Interaction

Section Details:

X Centroid: -1.93E-16 in
 Y Centroid: -2.12E-16 in
 Section Area: 331.3 in^2

Loading Details:

Angle of Loading: 0 deg
 Number of Points: 80
 Min. PreStress1 Nominal Stra 35.00E-3 Comp
 Max. PreStress1 Nominal Stra 35.00E-3 Ten
 Min. 5ksi Nominal Strain: 3.000E-3 Comp
 Max. 5ksi Nominal Strain: 1.0000 Ten

Analysis Results:

Max. Compression Load: 1353 kips
 Max. Tension Load: -661.0 kips
 Maximum Moment: 3742 kip-in
 P at Max. Moment: 408.5 kips
 Minimum Moment: -3742 kip-in
 P at Min. Moment: 408.5 kips
 Moment (Mxx) at P=0: 3299 kip-in
 Max. Code Comp. Load: 0 kips
 Max. Code Ten. Load: 0 kips
 Maximum Code Moment: 0 kip-in
 P at Max. Code Moment: 0 kips
 Minimum Code Moment: 0 kip-in
 P at Min. Code Moment: 0 kips
 PM Interaction Equation: Units in kip-in

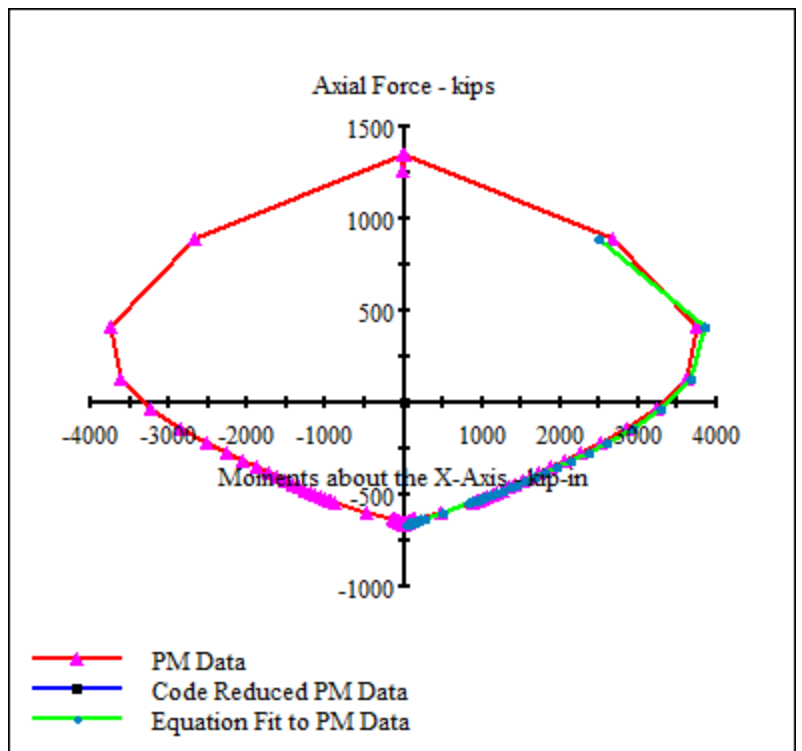
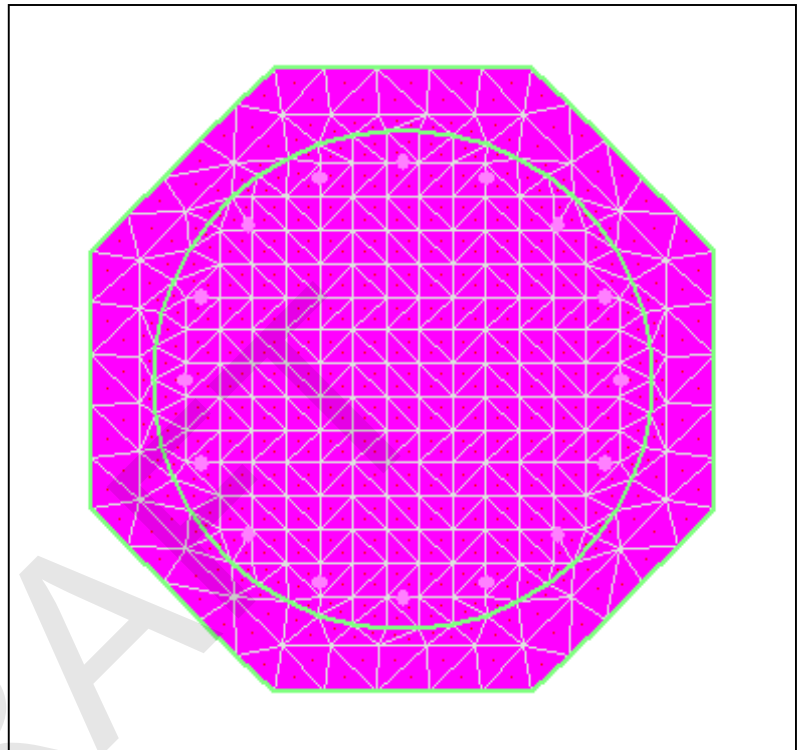

XTRACT Section Report

Moffatt & Nichol
Moffatt & Nichol
3/14/2018
Ocean Beach Pier
Piles
Page __ of __

Section Name: Original 20-in Mild Only

Section Details:

X Centroid: -1.59E-16 in
Y Centroid: -2.12E-16 in
Section Area: 331.3 in²
EI gross about X: 14.97E+6 kip-in²
EI gross about Y: 14.97E+6 kip-in²
I trans (5ksi Nominal) about X: 10.74E+3 in⁴
I trans (5ksi Nominal) about Y: 9434 in⁴
Reinforcing Bar Area: 12.49 in²
Percent Longitudinal Steel: 3.769 %
Overall Width: 20.00 in
Overall Height: 20.00 in
Number of Fibers: 522
Number of Bars: 8
Number of Materials: 2

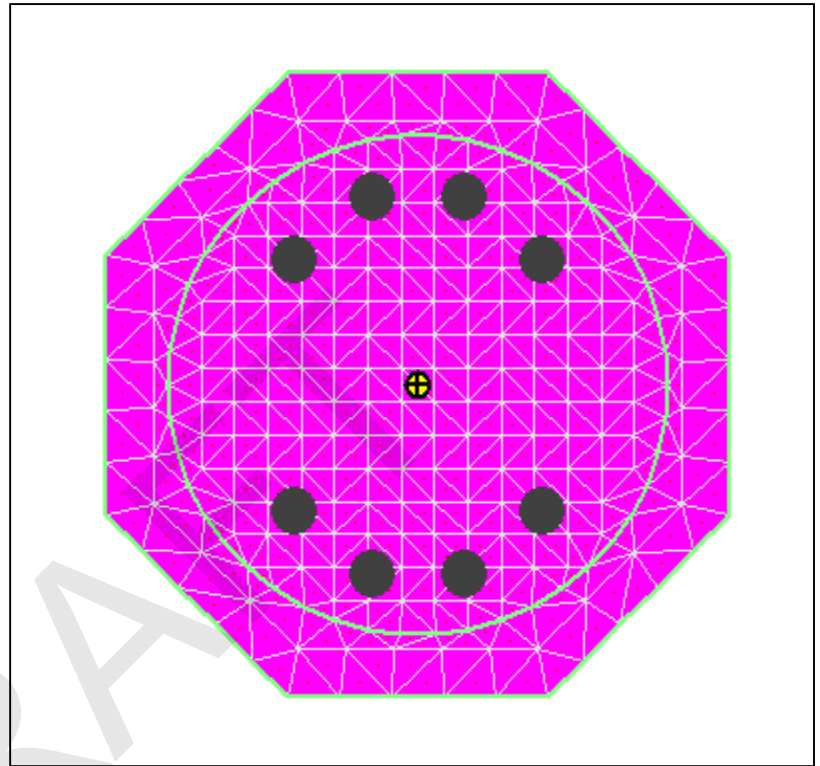

Material Types and Names:

Strain Hardening Steel: ■ Rebar60 Nomimnal
Unconfined Concrete: ■ 5ksi Nominal

Comments:

User Comments

XTRACT Section Report

Section Name: Original 20-in Mild Only

Moffatt & Nichol
Moffatt & Nichol
3/14/2018
Ocean Beach Pier
Piles
Page __ of __

Reinforcing Bar List:

Bar Number	X (in)	Y (in)	Bar Size	Area (in ²)	Prestress (kips)	Material Type
1	-1.500	6.000	#11	1.561	0	Rebar60 Nomimnal
2	-4.000	4.000	#11	1.561	0	Rebar60 Nomimnal
3	1.500	6.000	#11	1.561	0	Rebar60 Nomimnal
4	4.000	4.000	#11	1.561	0	Rebar60 Nomimnal
5	-4.000	-4.000	#11	1.561	0	Rebar60 Nomimnal
6	-1.500	-6.000	#11	1.561	0	Rebar60 Nomimnal
7	1.500	-6.000	#11	1.561	0	Rebar60 Nomimnal
8	4.000	-4.000	#11	1.561	0	Rebar60 Nomimnal

DRAFT

XTRACT Analysis Report

Moffatt & Nichol
Moffatt & Nichol
3/14/2018
Ocean Beach Pier
Piles
Page __ of __

Section Name: Original 20-in Mild Only
Loading Name: PM
Analysis Type: PM Interaction

Section Details:

X Centroid: -1.59E-16 in
Y Centroid: -2.12E-16 in
Section Area: 331.3 in²

Loading Details:

Angle of Loading: 0 deg
Number of Points: 80
Min. Rebar60 Nomimnal Strain 11.50E-3 Comp
Max. Rebar60 Nomimnal Strain 11.50E-3 Ten
Min. 5ksi Nominal Strain: 3.000E-3 Comp
Max. 5ksi Nominal Strain: 1.0000 Ten

Analysis Results:

Max. Compression Load: 2255 kips
Max. Tension Load: -749.3 kips
Maximum Moment: 5998 kip-in
P at Max. Moment: 439.6 kips
Minimum Moment: -5998 kip-in
P at Min. Moment: 439.6 kips
Moment (Mxx) at P=0: 4490 kip-in
Max. Code Comp. Load: 0 kips
Max. Code Ten. Load: 0 kips
Maximum Code Moment: 0 kip-in
P at Max. Code Moment: 0 kips
Minimum Code Moment: 0 kip-in
P at Min. Code Moment: 0 kips
PM Interaction Equation: Units in kip-in

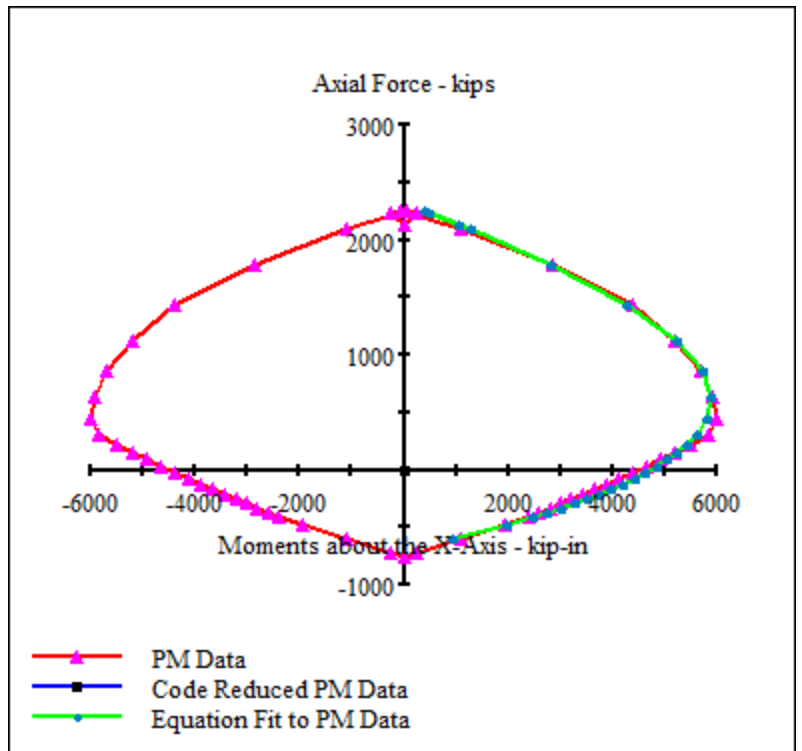
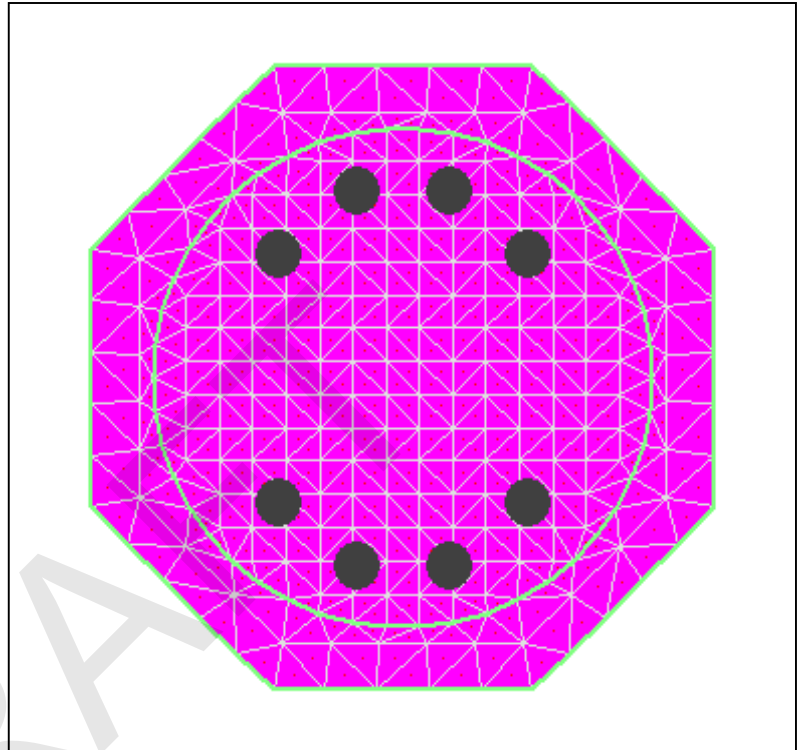

XTRACT Section Report

Moffatt & Nichol
Moffatt & Nichol
3/14/2018
Ocean Beach Pier
Piles
Page __ of __

Section Name: Original 20-in PS and Mild

Section Details:

X Centroid: -1.53E-16 in
Y Centroid: -1.36E-16 in
Section Area: 331.3 in²
EI gross about X: 14.97E+6 kip-in²
EI gross about Y: 14.97E+6 kip-in²
I trans (5ksi Nominal) about X: 11.11E+3 in⁴
I trans (5ksi Nominal) about Y: 9805 in⁴
Reinforcing Bar Area: 14.94 in²
Percent Longitudinal Steel: 4.508 %
Overall Width: 20.00 in
Overall Height: 20.00 in
Number of Fibers: 522
Number of Bars: 24
Number of Materials: 3

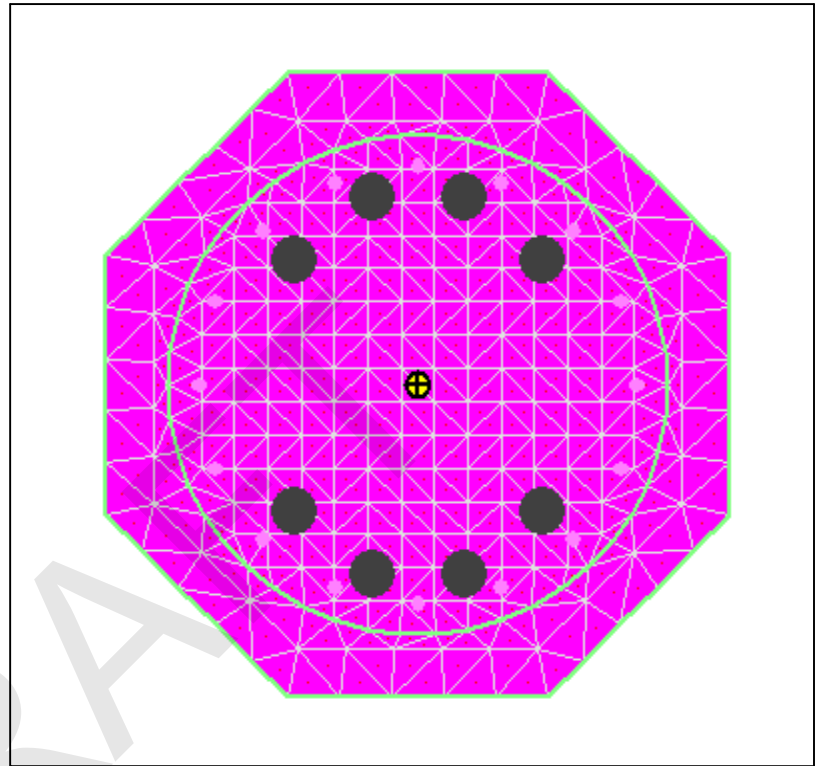

Material Types and Names:

Strain Hardening Steel: ■ Rebar60 Nomimnal
Prestressing Steel: ■ PreStress1 Nominal
Unconfined Concrete: ■ 5ksi Nominal

Comments:

User Comments

XTRACT Section Report

Section Name: Original 20-in PS and Mild

Moffatt & Nichol
Moffatt & Nichol
3/14/2018
Ocean Beach Pier
Piles
Page __ of __

Reinforcing Bar List:

Bar Number	X (in)	Y (in)	Bar Size	Area (in ²)	Prestress (kips)	Material Type
1	7.000	0	-	.1530	22.80	PreStress1 Nominal
2	6.470	2.680	-	.1530	22.80	PreStress1 Nominal
3	4.950	4.950	-	.1530	22.80	PreStress1 Nominal
4	2.680	6.470	-	.1530	22.80	PreStress1 Nominal
5	0	7.000	-	.1530	22.80	PreStress1 Nominal
6	-2.680	6.470	-	.1530	22.80	PreStress1 Nominal
7	-4.950	4.950	-	.1530	22.80	PreStress1 Nominal
8	-6.470	2.680	-	.1530	22.80	PreStress1 Nominal
9	-7.000	0	-	.1530	22.80	PreStress1 Nominal
10	-6.470	-2.680	-	.1530	22.80	PreStress1 Nominal
11	-4.950	-4.950	-	.1530	22.80	PreStress1 Nominal
12	-2.680	-6.470	-	.1530	22.80	PreStress1 Nominal
13	0	-7.000	-	.1530	22.80	PreStress1 Nominal
14	2.680	-6.470	-	.1530	22.80	PreStress1 Nominal
15	4.950	-4.950	-	.1530	22.80	PreStress1 Nominal
16	6.470	-2.680	-	.1530	22.80	PreStress1 Nominal
17	-1.500	6.000	#11	1.561	0	Rebar60 Nomimnal
18	-4.000	4.000	#11	1.561	0	Rebar60 Nomimnal
19	1.500	6.000	#11	1.561	0	Rebar60 Nomimnal
20	4.000	4.000	#11	1.561	0	Rebar60 Nomimnal
21	-4.000	-4.000	#11	1.561	0	Rebar60 Nomimnal
22	-1.500	-6.000	#11	1.561	0	Rebar60 Nomimnal
23	1.500	-6.000	#11	1.561	0	Rebar60 Nomimnal
24	4.000	-4.000	#11	1.561	0	Rebar60 Nomimnal

XTRACT Analysis Report

Moffatt & Nichol
Moffatt & Nichol
3/14/2018
Ocean Beach Pier
Piles
Page __ of __

Section Name: Original 20-in PS and Mild
Loading Name: PM
Analysis Type: PM Interaction

Section Details:

X Centroid: -1.53E-16 in
Y Centroid: -1.36E-16 in
Section Area: 331.3 in^2

Loading Details:

Angle of Loading: 0 deg
Number of Points: 80
Min. Rebar60 Nomimnal Strain 11.50E-3 Comp
Max. Rebar60 Nomimnal Strain 11.50E-3 Ten
Min. PreStress1 Nominal Stra 35.00E-3 Comp
Max. PreStress1 Nominal Stra 35.00E-3 Ten
Min. 5ksi Nominal Strain: 3.000E-3 Comp
Max. 5ksi Nominal Strain: 1.0000 Ten

Analysis Results:

Max. Compression Load: 2034 kips
Max. Tension Load: -1366 kips
Maximum Moment: 6569 kip-in
P at Max. Moment: 36.34 kips
Minimum Moment: -6569 kip-in
P at Min. Moment: 36.34 kips
Moment (Mxx) at P=0: 6535 kip-in
Max. Code Comp. Load: 0 kips
Max. Code Ten. Load: 0 kips
Maximum Code Moment: 0 kip-in
P at Max. Code Moment: 0 kips
Minimum Code Moment: 0 kip-in
P at Min. Code Moment: 0 kips
PM Interaction Equation: Units in kip-in

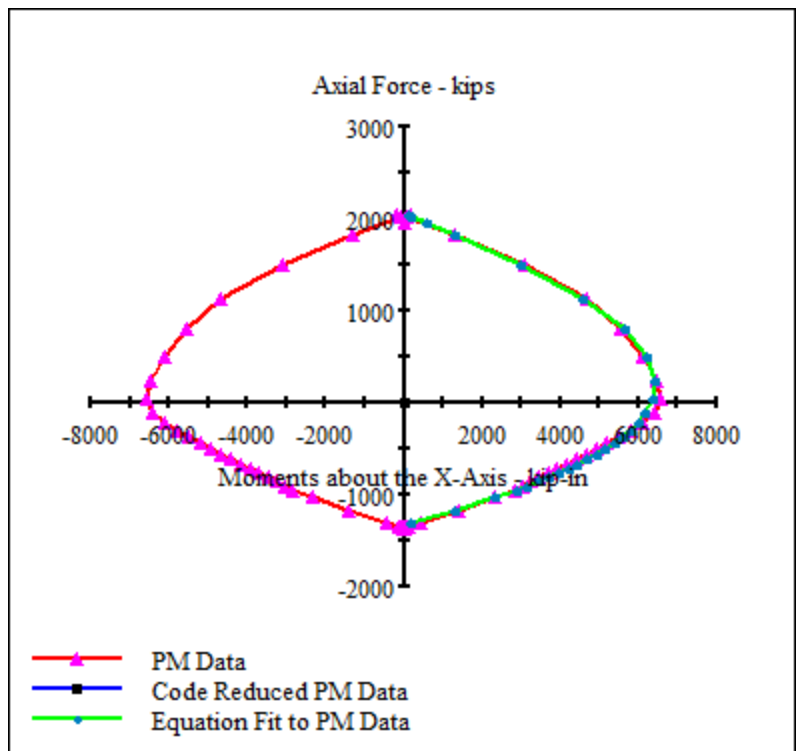
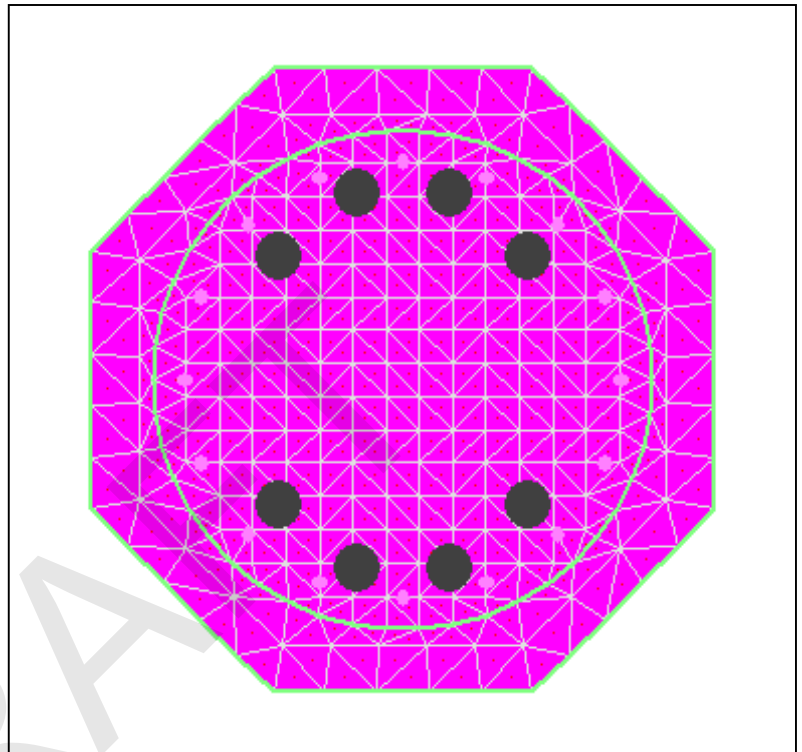

XTRACT Section Report

Moffatt & Nichol
Moffatt & Nichol
3/14/2018
Ocean Beach Pier
Piles
Page __ of __

Section Name: Repaired 20-in

Section Details:

X Centroid: -2.21E-15 in
Y Centroid: -3.34E-17 in
Section Area: 827.9 in²
EI gross about X: 14.97E+6 kip-in²
EI gross about Y: 14.97E+6 kip-in²
I trans (5ksi Nominal) about X: 62.06E+3 in⁴
I trans (5ksi Nominal) about Y: 62.06E+3 in⁴
Reinforcing Bar Area: 9.425 in²
Percent Longitudinal Steel: 1.138 %
Overall Width: 29.00 in
Overall Height: 29.00 in
Number of Fibers: 1924
Number of Bars: 12
Number of Materials: 2

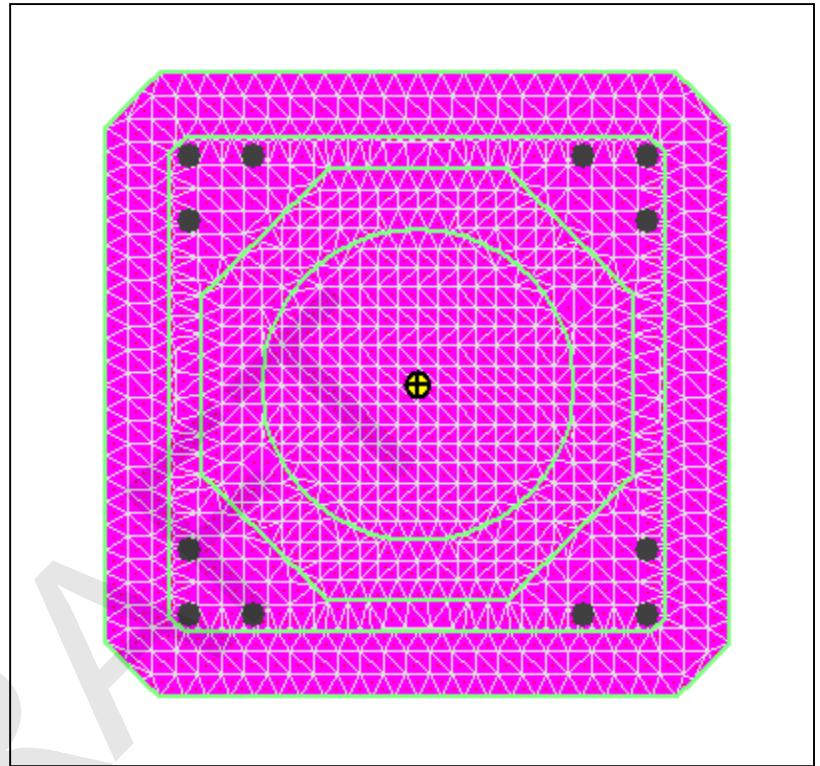

Material Types and Names:

Strain Hardening Steel: ■ Rebar60 Nomimnal
Unconfined Concrete: ■ 5ksi Nominal

Comments:

User Comments

XTRACT Section Report

Section Name: Repaired 20-in

Moffatt & Nichol
Moffatt & Nichol
3/14/2018
Ocean Beach Pier
Piles
Page __ of __

Reinforcing Bar List:

Bar Number	X (in)	Y (in)	Bar Size	Area (in ²)	Prestress (kips)	Material Type
1	-10.63	10.63	#8	.7854	0	Rebar60 Nomimnal
2	-7.630	10.63	#8	.7854	0	Rebar60 Nomimnal
3	-10.63	7.630	#8	.7854	0	Rebar60 Nomimnal
4	10.63	10.63	#8	.7854	0	Rebar60 Nomimnal
5	10.63	7.630	#8	.7854	0	Rebar60 Nomimnal
6	7.630	10.63	#8	.7854	0	Rebar60 Nomimnal
7	-10.63	-10.63	#8	.7854	0	Rebar60 Nomimnal
8	-10.63	-7.630	#8	.7854	0	Rebar60 Nomimnal
9	-7.630	-10.63	#8	.7854	0	Rebar60 Nomimnal
10	10.63	-10.63	#8	.7854	0	Rebar60 Nomimnal
11	10.63	-7.630	#8	.7854	0	Rebar60 Nomimnal
12	7.630	-10.63	#8	.7854	0	Rebar60 Nomimnal

XTRACT Analysis Report

Moffatt & Nichol
Moffatt & Nichol
3/14/2018
Ocean Beach Pier
Piles
Page __ of __

Section Name: Repaired 20-in
Loading Name: PM
Analysis Type: PM Interaction

Section Details:

X Centroid: -2.21E-15 in
Y Centroid: -3.34E-17 in
Section Area: 827.9 in^2

Loading Details:

Angle of Loading: 0 deg
Number of Points: 80
Min. Rebar60 Nomimnal Strain 11.50E-3 Comp
Max. Rebar60 Nomimnal Strain 11.50E-3 Ten
Min. 5ksi Nominal Strain: 3.000E-3 Comp
Max. 5ksi Nominal Strain: 1.0000 Ten

Analysis Results:

Max. Compression Load: 4458 kips
Max. Tension Load: -565.5 kips
Maximum Moment: 18.20E+3 kip-in
P at Max. Moment: 1595 kips
Minimum Moment: -18.20E+3 kip-in
P at Min. Moment: 1595 kips
Moment (Mxx) at P=0: 6762 kip-in
Max. Code Comp. Load: 0 kips
Max. Code Ten. Load: 0 kips
Maximum Code Moment: 0 kip-in
P at Max. Code Moment: 0 kips
Minimum Code Moment: 0 kip-in
P at Min. Code Moment: 0 kips
PM Interaction Equation: Units in kip-in

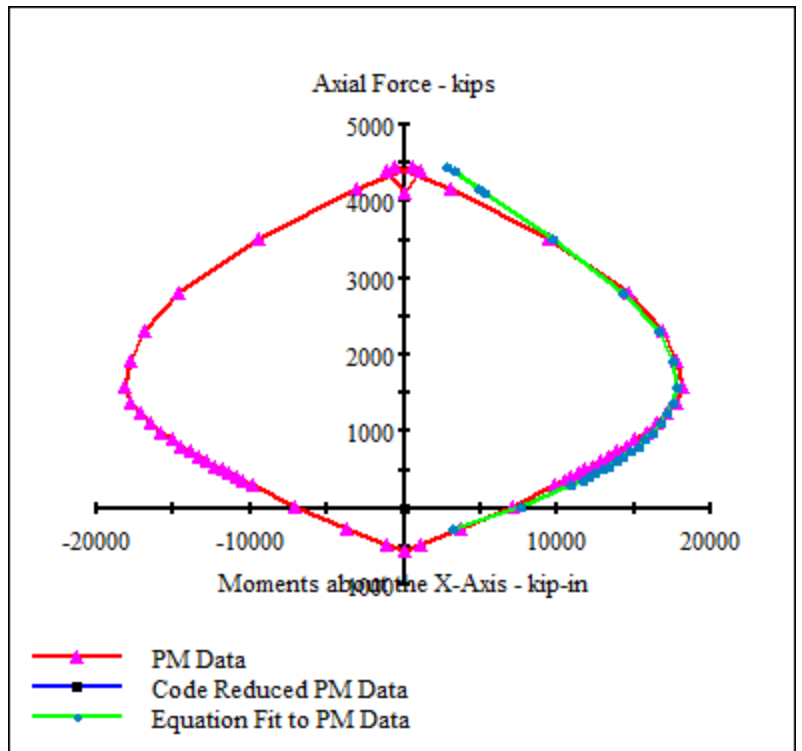
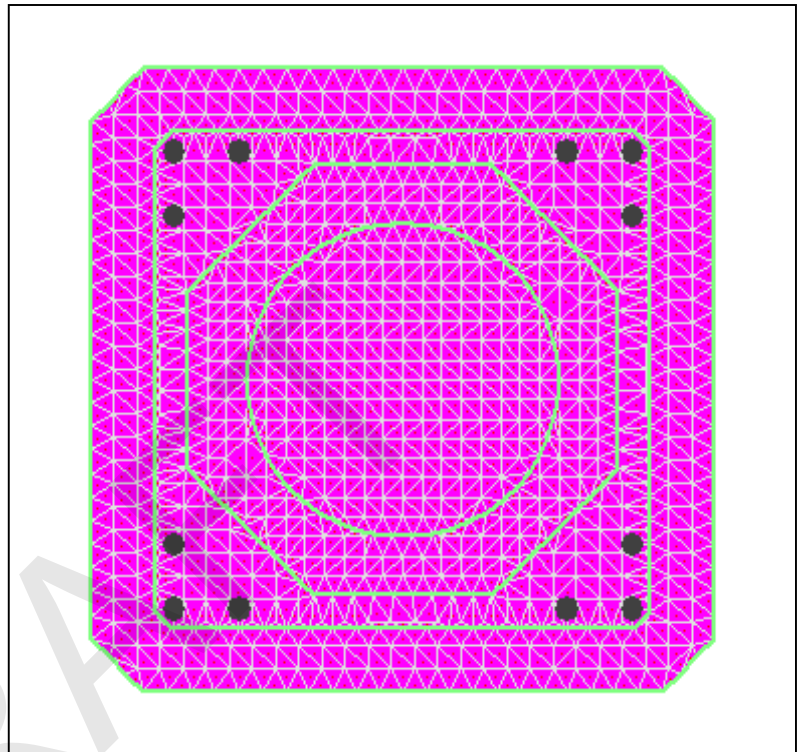



Methodology:

These calculations follow the provisions of ACI 318–14 for the shear design of prestressed concrete members

$$V_u = 0 \text{ kip}$$

$$M_u = 1 \text{ kip} \cdot \text{ft}$$

Since the demands are unknown, use V_u and M_u to arbitrarily set the shear capacity to a minimum, so that $V_u \cdot d / M_u = 0$

Shear demand at the section in interest

Simultaneous flexural demand at the section in interest

Material Properties:

$$f'_c = 5 \text{ ksi}$$

$$f_y = 60 \text{ ksi}$$

$$\phi = 0.75$$

$$\lambda = 1.0$$

Compressive strength of concrete

Yield strength of shear reinforcement

Strength reduction factor for shear per Table 21.2.1(b)

Lightweight concrete modification factor per Table 19.2.4.2

Section Properties:

$$D = 20 \text{ in}$$

$$b_w = D = 20 \cdot \text{in}$$

$$d_p = 0.8 \cdot D = 16 \cdot \text{in}$$

Diameter of the circular member

Width of the web of the section, taken as D for circular members.

Depth of the concrete section from the compressive face to the centroid of the tensile steel Taken as 0.8D per 22.5.2.2

Shear Reinforcement:

$$A_v = 2 \cdot (0.05 \text{ in}^2) = 0.1 \cdot \text{in}^2$$

$$s = 3 \text{ in}$$

Area of shear reinforcement (include all legs of the stirrups)

Spacing of the shear reinforcement

Shear Strength:

$$\frac{V_u \cdot d_p}{M_u} = 0$$

$$V_c = \begin{cases} (0.6 \cdot \lambda \cdot \sqrt{f'_c \cdot \text{psi}} + 700 \text{ psi}) \cdot b_w \cdot d_p & \text{if } \frac{V_u \cdot d_p}{M_u} > 1.0 \\ \left(0.6 \cdot \lambda \cdot \sqrt{f'_c \cdot \text{psi}} + 700 \text{ psi} \cdot \frac{V_u \cdot d_p}{M_u} \right) \cdot b_w \cdot d_p & \text{otherwise} \end{cases}$$

Nominal shear strength provided by the concrete per Table 22.5.8.2. Assumes that the effective prestress, f_{pe} , is greater than $0.4f_{pu}$

$$V_c = 13.6 \cdot \text{kip}$$

$$V_{c,\text{min}} = 2 \cdot \lambda \cdot \sqrt{f'_c \cdot \text{psi}} \cdot b_w \cdot d_p = 45.3 \cdot \text{kip}$$

$$V_{c,\text{max}} = 5 \cdot \lambda \cdot \sqrt{f'_c \cdot \text{psi}} \cdot b_w \cdot d_p = 113.1 \cdot \text{kip}$$

$$V_c = \begin{cases} V_c & \text{if } V_{c,\text{min}} < V_c < V_{c,\text{max}} = 45.3 \cdot \text{kip} \\ V_{c,\text{min}} & \text{if } V_c < V_{c,\text{min}} \\ V_{c,\text{max}} & \text{if } V_c > V_{c,\text{max}} \end{cases}$$



$$V_{s1} = \frac{A_v \cdot f_y \cdot d_p}{s} = 32 \cdot \text{kip}$$

Nominal shear strength provided by the steel reinforcement per 22.5.10.5.3

$$V_{s,\max} = 8 \cdot \sqrt{f'_c \cdot \text{psi}} \cdot b_w \cdot d_p = 181 \cdot \text{kip}$$

Maximum shear reinforcement contribution to the nominal shear strength per 22.5.1.2

$$V_s = \min(V_{s1}, V_{s,\max}) = 32 \cdot \text{kip}$$

Nominal shear strength provided by the steel with upper limit

$$\phi V_n = \phi \cdot (V_c + V_s) = 58 \cdot \text{kip}$$

Reduced shear strength of the section per 22.5.1.1.1

Check Shear Reinforcement Spacing:

$$V_{s,\text{limit}} = 4 \cdot \sqrt{f'_c \cdot \text{psi}} \cdot b_w \cdot d_p = 90.5 \cdot \text{kip}$$

Limiting shear reinforcement strength for reduced stirrup spacing per 9.7.6.2.2

$$s_{\max} = \begin{cases} \frac{d_p}{2} & \text{if } V_s \leq V_{s,\text{limit}} \\ \frac{d_p}{4} & \text{otherwise} \end{cases} = 8 \cdot \text{in}$$

Maximum shear reinforcement spacing per 9.7.6.2.2

$$\text{CHECK} = \begin{cases} \text{"OK!"} & \text{if } s \leq s_{\max} \\ \text{"NG!"} & \text{otherwise} \end{cases} = \text{"OK!"}$$

Check Minimum Shear Reinforcement:

$$A_{v,\min} = \max \left(0.75 \cdot \sqrt{f'_c \cdot \text{psi}} \cdot \frac{b_w \cdot s}{f_y}, 50 \text{psi} \cdot \frac{b_w \cdot s}{f_y} \right) = 0.05 \cdot \text{in}^2$$

Minimum shear reinforcement required per 9.6.3.3

$$\text{CHECK} = \begin{cases} \text{"OK!"} & \text{if } A_v \geq A_{v,\min} \\ \text{"NG!"} & \text{otherwise} \end{cases} = \text{"OK!"}$$

**Methodology:**

These calculations follow the provisions of ACI 318–14 for the shear design of reinforced concrete members ignoring any effects of axial load or prestress on the member.

Material Properties:

$f'_c = 5\text{ksi}$	Compressive strength of concrete
$f_y = 60\text{ksi}$	Yield strength of shear reinforcement
$\phi = 0.75$	Strength reduction factor for shear per Table 21.2.1
$\lambda = 1.0$	Lightweight concrete modification factor per Table 19.2.4.2

Section Properties:

$b_w = 29\text{in}$	Width of the web of the section
$d = 29\text{in}$	Depth of the concrete section from the compressive face to the centroid of the tensile steel

Shear Reinforcement:

$A_v = 2(0.2\text{in}^2) = 0.4 \cdot \text{in}^2$	Area of shear reinforcement (include all legs of the stirrups)
$s = 3\text{in}$	Spacing of the shear reinforcement

Shear Strength:

$V_c = 2 \cdot \lambda \cdot \sqrt{f'_c \cdot \text{psi}} \cdot b_w \cdot d = 118.9 \cdot \text{kip}$	Nominal shear strength provided by the concrete per 22.5.5.1
$V_{s1} = \frac{A_v \cdot f_y \cdot d}{s} = 232 \cdot \text{kip}$	Nominal shear strength provided by the steel reinforcement per 22.5.10.5.3
$V_{s,\text{max}} = 8 \cdot \sqrt{f'_c \cdot \text{psi}} \cdot b_w \cdot d = 475.7 \cdot \text{kip}$	Maximum shear reinforcement contribution to the nominal shear strength per 22.5.1.2
$V_s = \min(V_{s1}, V_{s,\text{max}}) = 232 \cdot \text{kip}$	Nominal shear strength provided by the steel with upper limit
$\phi V_n = \phi \cdot (V_c + V_s) = 263 \cdot \text{kip}$	Reduced shear strength of the section per 22.5.1.1

Check Shear Reinforcement Spacing:

$V_{s,\text{limit}} = 4 \cdot \sqrt{f'_c \cdot \text{psi}} \cdot b_w \cdot d = 237.9 \cdot \text{kip}$	Limiting shear reinforcement strength for reduced stirrup spacing per Table 9.7.6.2.2
$s_{\text{max}} = \begin{cases} \min\left(\frac{d}{2}, 24\text{in}\right) & \text{if } V_s \leq V_{s,\text{limit}} \\ \min\left(\frac{d}{4}, 24\text{in}\right) & \text{otherwise} \end{cases} = 14.5 \cdot \text{in}$	Maximum shear reinforcement spacing per Table 9.7.6.2.2
CHECK = $\begin{cases} \text{"OK!"} & \text{if } s \leq s_{\text{max}} \\ \text{"NG!"} & \text{otherwise} \end{cases} = \text{"OK!"}$	



Check Minimum Shear Reinforcement:

$$A_{v.min} = \max \left(0.75 \cdot \sqrt{f'_c} \cdot \text{psi} \cdot \frac{b_w \cdot s}{f_y}, 50 \text{psi} \cdot \frac{b_w \cdot s}{f_y} \right) = 0.08 \cdot \text{in}^2$$

Minimum shear reinforcement required per 9.6.3.3

CHECK = | "OK!" if $A_v \geq A_{v.min}$ = "OK!"
 | "NG!" otherwise

DRAFT

APPENDIX D- COST ESTIMATES

DRAFT

COST ESTIMATE				
CLIENT: CITY OF SAN DIEGO SAN DIEGO, CALIFORNIA		Date: 30 NOV 2018		
PROJECT: OCEAN BEACH PIER REPAIR		CONCEPT ESTIMATE		
DESCRIPTION	QUANTITY	UNITS	UNIT COST	COST
NOTE:				
THIS COST ESTIMATE IS AN OPINION OF CONSTRUCTION COST MADE BY THE CONSULTANT. IN PROVIDING OPINIONS OF CONSTRUCTION COST, IT IS RECOGNIZED THAT NEITHER THE CLIENT NOR THE CONSULTANT HAS CONTROL OVER THE COSTS OF LABOR, EQUIPMENT, OR MATERIALS, OR OVER CONTRACTORS' METHODS OF DETERMINING PRICES OR BIDDING. THIS OPINION OF CONSTRUCTION COST IS BASED ON THE CONSULTANT'S REASONABLE PROFESSIONAL JUDGMENT AND EXPERIENCE AND DOES NOT CONSTITUTE A WARRANTY, EXPRESS OR IMPLIED, THAT CONTRACTORS' BIDS OR NEGOTIATED PRICES OF THE WORK WILL NOT VARY FROM THE CLIENT'S BUDGET OR FROM ANY OPINION OF COST PREPARED BY THE CONSULTANT.				
SPALL REPAIRS / WITH ANODES	5,500	CF	750.00	4,125,000
PILE JACKET / PREP	300	LF	1,500.00	450,000
DECK SLAB SUPPORT BEAMS	125	EA	9,528.06	1,191,008
GUARDRAIL WORK	2,000	LF	94.80	189,609
SUBTOTAL				5,955,617
MOBILIZATION AND DEMOBILIZATION 10%				595,562
MARK UP FOR GENERAL REQUIREMENTS 30%				1,786,685
TOTAL				8,337,864

COST ESTIMATE				
CLIENT: CITY OF SAN DIEGO SAN DIEGO, CALIFORNIA			Date: November 30, 2018	
PROJECT: OCEAN BEACH PIER REHABILITATION			CONCEPT ESTIMATE	
DESCRIPTION			QUANTITY	UNITS
			UNIT COST	COST
PROVIDE REHABILITATION OF OCEAN BEACH PIER				
PIER STRUCTURE				
PILE REHABILITATION				
PILE PREPARATION	220	EA	1,500.00	330,000
PILE JACKET	10,483	LF	700	7,338,100
SUPERSTRUCTURE SYSTEM				
CONCRETE CAPS AND DECK	52,660	SF	200	10,532,000
PIER APPURTENANCES				
PIER UTILITIES:				
FRESH WATER	2,550	LF	70	178,500
SANITARY SEWER	2,550	LF	60	153,000
ELECTRIC	2,550	LF	50	127,500
SEWAGE LIFT STATION	1	EA	20,000	20,000
PIER LIGHTING - LIGHT FIXTURES	40	EA	7,500	300,000
RESTAURANT/RESTROOM BUILDING	2,460	SQ FT	500	1,230,000
RESTROOM FIXTURES	14	EA	2,000	28,000
FISH CLEANING SINKS	6	EA	2,000	12,000
DRINKING FOUNTAINS	6	EA	3,000	18,000
BENCHES	19	EA	1,000	19,000
DEMOLITION OF SUPERSTRUCTURE				
CONCRETE DEMOLITION	5,000	TONS	500	2,500,000
CONCRETE DEBRIS DUMP FEES	5,000	TONS	100	500,000
WOOD FRAME CONSTRUCTION DEMOLITION	2,460	SQ FT	4	9,840
WOOD FRAME CONSTRUCTION DUMP FEES	37	TONS	100	3,700
HAULAGE	450	LOADS	300	135,000
SUBTOTAL				23,434,640
MOBILIZATION AND DEMOBILIZATION 10%				2,343,464
MARK UP FOR GENERAL REQUIREMENTS 30%				7,030,392
SUBTOTAL				32,808,496
CONTINGENCIES @ 25%				8,202,124
TOTAL				41,010,620
NOTE:				
THIS COST ESTIMATE IS AN OPINION OF CONSTRUCTION COST MADE BY THE CONSULTANT. IN PROVIDING OPINIONS OF CONSTRUCTION COST, IT IS RECOGNIZED THAT NEITHER THE CLIENT NOR THE CONSULTANT HAS CONTROL OVER THE COSTS OF LABOR, EQUIPMENT, OR MATERIALS, OR OVER CONTRACTORS' METHODS OF DETERMINING PRICES OR BIDDING. THIS OPINION OF CONSTRUCTION COST IS BASED ON THE CONSULTANT'S REASONABLE PROFESSIONAL JUDGMENT AND EXPERIENCE AND DOES NOT CONSTITUTE A WARRANTY, EXPRESS OR IMPLIED, THAT CONTRACTORS' BIDS OR NEGOTIATED PRICES OF THE WORK WILL NOT VARY FROM THE CLIENT'S BUDGET OR FROM ANY OPINION OF COST PREPARED BY THE CONSULTANT.				

COST ESTIMATE						
CLIENT: CITY OF SAN DIEGO SAN DIEGO, CALIFORNIA			Date: November 30, 2018			
PROJECT: OCEAN BEACH PIER - NEW PIER REPLACEMENT			CONCEPT ESTIMATE			
DESCRIPTION			QUANTITY	UNITS	UNIT COST	COST
PROVIDE REPLACEMENT OF OCEAN BEACH PIER BY CONSTRUCTING A NEW PIER AND SUBSEQUENTLY DEMOLISHING AND REMOVING THE EXISTING PIER.						
PIER STRUCTURE						
PILE SYSTEM						
NEW PILES	10,483	LF	1,000	10,483,000		
AUGER SOCKET	220	EA	8,000	1,760,000		
SUPERSTRUCTURE SYSTEM						
CONCRETE CAPS AND DECK	52,660	SF	200	10,532,000		
PIER APPURTENANCES						
PIER UTILITIES:						
FRESH WATER	2,550	LF	70	178,500		
SANITARY SEWER	2,550	LF	60	153,000		
ELECTRIC	2,550	LF	50	127,500		
SEWAGE LIFT STATION	1	EA	20,000	20,000		
PIER LIGHTING - LIGHT FIXTURES	40	EA	7,500	300,000		
RESTAURANT/RESTROOM BUILDING	2,460	SQ FT	500	1,230,000		
RESTROOM FIXTURES	14	EA	2,000	28,000		
FISH CLEANING SINKS	6	EA	2,000	12,000		
DRINKING FOUNTAINS	6	EA	3,000	18,000		
BENCHES	19	EA	1,000	19,000		
DEMOLITION OF EXISTING PIER						
PILE CUT OFF	220	EA	2,000	440,000		
CONCRETE DEMOLITION	6,425	TONS	500	3,212,500		
CONCRETE DEBRIS DUMP FEES	6,425	TONS	100	642,500		
WOOD FRAME CONSTRUCTION DEMOLITION	2,460	SQ FT	4	9,840		
WOOD FRAME CONSTRUCTION DUMP FEES	37	TONS	100	3,700		
HAULAGE	450	LOADS	300	135,000		
SUBTOTAL				29,304,540		
MOBILIZATION AND DEMOBILIZATION 10%				2,930,454		
MARK UP FOR GENERAL REQUIREMENTS 30%				8,791,362		
SUBTOTAL				41,026,356		
CONTINGENCIES @ 20%				8,205,271		
TOTAL				49,231,627		
NOTE:						
THIS COST ESTIMATE IS AN OPINION OF CONSTRUCTION COST MADE BY THE CONSULTANT. IN PROVIDING OPINIONS OF CONSTRUCTION COST, IT IS RECOGNIZED THAT NEITHER THE CLIENT NOR THE CONSULTANT HAS CONTROL OVER THE COSTS OF LABOR, EQUIPMENT, OR MATERIALS, OR OVER CONTRACTORS' METHODS OF DETERMINING PRICES OR BIDDING. THIS OPINION OF CONSTRUCTION COST IS BASED ON THE CONSULTANT'S REASONABLE PROFESSIONAL JUDGMENT AND EXPERIENCE AND DOES NOT CONSTITUTE A WARRANTY, EXPRESS OR IMPLIED, THAT CONTRACTORS' BIDS OR NEGOTIATED PRICES OF THE WORK WILL NOT VARY FROM THE CLIENT'S BUDGET OR FROM ANY OPINION OF COST PREPARED BY THE CONSULTANT.						